

R&S® RTB2000

Digital Oscilloscope

User Manual



1333161102

This manual describes the following R&S®RTB2000 models with firmware version 2.2xx:

- R&S®RTB2002 (1333.1005K02)
- R&S®RTB2004 (1333.1005K04)

© 2019 Rohde & Schwarz GmbH & Co. KG

Mühlhofstr. 15, 81671 München, Germany

Phone: +49 89 41 29 - 0

Fax: +49 89 41 29 12 164

Email: info@rohde-schwarz.com

Internet: www.rohde-schwarz.com

Subject to change – Data without tolerance limits is not binding.

R&S® is a registered trademark of Rohde & Schwarz GmbH & Co. KG.

Trade names are trademarks of the owners.

1333.1611.02 | Version 08 | R&S®RTB2000

Throughout this manual, products from Rohde & Schwarz are indicated without the ® symbol, e.g. R&S®RTB is indicated as R&S RTB2000.

Contents

1	Preface	13
1.1	Safety Information	13
1.2	Documentation Overview	14
1.2.1	Manuals and Instrument Help.....	14
1.2.2	Data Sheet and Brochure.....	15
1.2.3	Calibration Certificate.....	15
1.2.4	Release Notes and Open Source Acknowledgment.....	15
1.3	Conventions Used in the Documentation	15
1.3.1	Typographical Conventions.....	15
1.3.2	Conventions for Procedure Descriptions.....	16
1.3.3	Notes on Screenshots.....	16
2	Getting Started	17
2.1	Preparing for Use	17
2.1.1	Unpacking and Checking the Instrument.....	17
2.1.2	Positioning the Instrument.....	17
2.1.3	Starting the Instrument.....	18
2.2	Instrument Tour	20
2.2.1	Front Panel.....	20
2.2.2	Rear Panel.....	23
3	Operating Basics	25
3.1	Display Overview	25
3.2	Selecting the Application	26
3.3	Using the Touchscreen	26
3.3.1	Accessing Functionality Using the Main Menu.....	26
3.3.2	Accessing Functionality Using Shortcuts.....	28
3.3.3	Entering Data.....	28
3.3.4	Using Gestures.....	29
3.4	Front Panel Keys	30
3.4.1	Action Controls.....	30
3.4.2	Analysis Controls.....	31
3.5	Using the Toolbar	32

3.6	Quick Access.....	33
3.7	Menu History.....	34
3.8	Getting Help.....	35
4	Waveform Setup.....	36
4.1	Connecting Probes and Displaying a Signal.....	36
4.2	Adjusting Passive Probes.....	37
4.3	Vertical Setup.....	38
4.3.1	VERTICAL Controls.....	39
4.3.2	Short Menu for Analog Channels.....	40
4.3.3	Vertical Settings.....	41
4.3.4	Probe Settings.....	45
4.3.5	Threshold Settings.....	46
4.3.6	Label Settings.....	47
4.4	Horizontal Setup.....	48
4.4.1	HORIZONTAL Controls.....	49
4.4.2	Shortcuts for Horizontal Settings.....	50
4.4.3	Horizontal Settings.....	51
4.5	Acquisition Setup.....	52
4.5.1	Shortcuts for Acquisition Settings.....	52
4.5.2	Acquisition Settings.....	53
5	Trigger.....	57
5.1	Trigger Controls.....	58
5.2	Shortcuts for Trigger Settings.....	59
5.3	General Trigger Settings.....	60
5.4	Edge Trigger.....	62
5.5	Width Trigger.....	64
5.6	Video Trigger.....	67
5.7	Pattern Trigger.....	69
5.8	Timeout Trigger.....	71
5.9	Trigger Out Signal.....	73
6	Waveform Analysis.....	74
6.1	Zoom.....	74

6.1.1	Zooming In.....	74
6.1.2	Modifying the Zoom.....	76
6.1.3	Zoom Settings.....	77
6.2	Mathematics.....	78
6.2.1	Short Menu for Math Waveforms.....	78
6.2.2	Configuring Math Waveforms.....	79
6.2.3	Settings for Math Waveforms.....	79
6.2.4	Mathematic Functions.....	80
6.2.5	Saving and Loading Formularies.....	82
6.3	Reference Waveforms.....	83
6.3.1	Using References.....	84
6.3.2	Settings for Reference Waveforms.....	85
6.4	History and Segmented Memory (Option R&S RTB-K15).....	87
6.4.1	Segmented Memory.....	88
6.4.2	Activating the History.....	89
6.4.3	History Settings.....	89
6.4.4	Segment Table and History Player.....	91
6.4.5	Exporting History Data.....	93
6.5	Search.....	96
6.5.1	Search Conditions and Results.....	96
6.5.2	General Search Settings.....	99
6.5.3	Edge Search.....	101
6.5.4	Width Search.....	102
6.5.5	Peak Search.....	103
6.5.6	Rise/Fall Time Search.....	103
6.5.7	Runt Setup.....	105
6.5.8	Data2Clock.....	106
6.5.9	Pattern Search.....	108
7	Measurements.....	111
7.1	Quick Measurements.....	111
7.2	Automatic Measurements.....	112
7.2.1	Measurement Results.....	112
7.2.2	Measurement Types.....	114

7.2.3	Settings for Automatic Measurements.....	118
7.3	Cursor Measurements.....	121
7.3.1	Cursor Settings.....	122
8	Applications.....	125
8.1	Mask Testing.....	125
8.1.1	About Masks and Mask Testing.....	125
8.1.2	Using Masks.....	126
8.1.3	Mask Window.....	129
8.1.4	Mask Menu.....	130
8.2	FFT Analysis.....	133
8.2.1	FFT Display.....	133
8.2.2	Performing FFT Analysis.....	135
8.2.3	FFT Setup.....	135
8.3	XY-Diagram.....	140
8.4	Digital Voltmeter.....	142
8.4.1	Using the Meter.....	142
8.4.2	Meter Settings.....	143
8.5	Trigger Counter.....	144
8.6	Bode Plot (Option R&S RTB-K36).....	145
8.6.1	About the Bode Plot.....	146
8.6.2	Using a Bode Plot.....	147
8.6.3	Bode Plot Window Controls.....	149
8.6.4	Bode Plot Settings.....	150
9	Documenting Results.....	154
9.1	Saving and Loading Instrument Settings.....	155
9.2	Saving Waveform Data.....	156
9.2.1	Waveform Export Settings.....	157
9.2.2	Waveform File Formats.....	158
9.3	Annotations.....	160
9.4	Screenshots.....	161
9.5	Quick Save with OneTouch.....	163
9.6	Export and Import.....	164

10	General Instrument Setup.....	166
10.1	Instrument Settings.....	166
10.2	Display Settings.....	169
10.3	Reset.....	172
10.4	Locking the Touchscreen.....	173
10.5	Performing a Self-Alignment.....	173
10.6	Setting the Data, Time and Language.....	174
10.7	Options.....	175
10.7.1	Activating Options.....	175
10.8	Updating the Firmware.....	176
11	Network Connections and Remote Operation.....	178
11.1	LAN Connection.....	178
11.2	USB Connection.....	181
11.2.1	USB TMC.....	181
11.2.2	USB VCP.....	182
11.2.3	USB MTP.....	182
11.3	Remote Access Using a Web Browser.....	182
11.3.1	Accessing the Instrument Using a Web Browser.....	182
11.3.2	Instrument Home.....	183
11.3.3	Screenshot.....	183
11.3.4	SCPI Device Control.....	184
11.3.5	Save/Load.....	185
11.3.6	Network Settings.....	186
11.3.7	Change Password.....	187
11.3.8	Livescreen.....	187
11.3.9	Remote Front Panel.....	187
12	Serial Bus Analysis.....	188
12.1	Basics of Protocol Analysis.....	188
12.1.1	Protocol - Common Settings.....	189
12.1.2	Displaying Decode Results.....	191
12.1.3	Bus Table: Decode Results.....	192
12.1.4	Bus Labels.....	194
12.1.5	Label List.....	195

12.2	SPI Bus (Option R&S RTB-K1)	198
12.2.1	The SPI Protocol.....	198
12.2.2	SPI Configuration.....	199
12.2.3	SPI Trigger.....	202
12.2.4	SPI Decode Results	205
12.3	I²C (Option R&S RTB-K1)	206
12.3.1	The I ² C Protocol.....	206
12.3.2	I ² C Configuration.....	208
12.3.3	I ² C Trigger.....	209
12.3.4	I ² C Decode Results	212
12.3.5	I ² C Label List.....	213
12.4	UART / RS232 (Option R&S RTB-K2)	215
12.4.1	The UART / RS232 Interface.....	215
12.4.2	UART Configuration.....	216
12.4.3	UART Trigger.....	219
12.4.4	UART Decode Results	221
12.5	CAN (Option R&S RTB-K3)	222
12.5.1	The CAN Protocol.....	223
12.5.2	CAN Configuration.....	224
12.5.3	CAN Trigger.....	226
12.5.4	CAN Decode Results.....	230
12.5.5	Search on Decoded CAN Data.....	232
12.5.6	CAN Label List.....	234
12.6	LIN (Option R&S RTB-K3)	236
12.6.1	The LIN Protocol.....	236
12.6.2	LIN Configuration.....	238
12.6.3	LIN Trigger.....	240
12.6.4	LIN Decode Results	243
12.6.5	Search on Decoded LIN Data.....	244
12.6.6	LIN Label List.....	247
13	Logic Analyzer (Option R&S RTB-B1, MSO)	250
13.1	Short Menu for Logic Channels	250
13.2	Logic Analyzer Settings	252

13.3	Triggering on Logic Channels.....	254
13.4	Analyzing Logic Channels.....	254
13.5	Parallel Buses.....	254
13.5.1	Parallel Bus Configuration.....	255
13.5.2	Decode Results.....	257
14	Signal Generation (Option R&S RTB-B6).....	259
14.1	Function Generator.....	259
14.1.1	Using the Function Generator.....	259
14.1.2	Basic Settings of the Function Generator	262
14.1.3	Sweep Settings.....	265
14.1.4	Modulation Settings.....	266
14.1.5	Burst Settings.....	268
14.1.6	Arbitrary Setup Settings.....	269
14.2	Pattern Generator.....	271
14.2.1	Pattern Selection.....	272
14.2.2	Settings for Square Wave Pattern.....	272
14.2.3	Settings for Counter Pattern.....	273
14.2.4	Settings for Arbitrary Pattern.....	274
14.2.5	Settings for Manual Pattern.....	277
14.2.6	Settings for Serial Buses.....	277
15	Remote Control Commands.....	279
15.1	Conventions used in Command Description.....	279
15.2	Programming Examples.....	280
15.2.1	Documenting Results.....	280
15.2.2	Firmware Update.....	284
15.2.3	Search.....	285
15.2.4	Function Generator.....	286
15.3	Common Commands.....	286
15.4	Waveform Setup.....	289
15.4.1	Automatic Setup.....	290
15.4.2	Starting and Stopping Acquisition.....	290
15.4.3	Vertical Settings.....	291
15.4.4	Passive Probes.....	298

15.4.5	Horizontal Settings.....	299
15.4.6	Acquisition Settings.....	301
15.4.7	Waveform Data.....	306
15.5	Trigger.....	306
15.5.1	General Trigger Settings.....	306
15.5.2	Edge Trigger.....	308
15.5.3	Width Trigger.....	310
15.5.4	Video/TV Trigger.....	312
15.5.5	Pattern Trigger.....	313
15.5.6	Timeout Trigger.....	316
15.5.7	Serial Bus.....	316
15.6	Waveform Analysis.....	317
15.6.1	Zoom.....	317
15.6.2	Mathematics.....	318
15.6.3	Reference Waveforms.....	320
15.6.4	Search.....	324
15.6.5	History (Option R&S RTB-K15).....	338
15.7	Measurements.....	349
15.7.1	Quick Measurements.....	349
15.7.2	Automatic Measurements.....	350
15.7.3	Cursor Measurements.....	361
15.8	Applications.....	367
15.8.1	General.....	367
15.8.2	Mask Testing.....	367
15.8.3	FFT Analysis.....	373
15.8.4	Spectrum Analysis (Option R&S RTB-K18).....	380
15.8.5	XY-Waveforms.....	388
15.8.6	Digital Voltmeter.....	389
15.8.7	Trigger Counter.....	391
15.8.8	Bode Plot (Option R&S RTB-K36).....	392
15.9	Documenting Results.....	400
15.9.1	Transfer of Waveform Data.....	400
15.9.2	Waveform Data Export to File.....	412

15.9.3	Screenshots.....	413
15.9.4	Instrument Settings: Mass MEMomory Subsystem.....	414
15.10	General Instrument Setup.....	421
15.10.1	Display Settings.....	421
15.10.2	System Settings.....	426
15.10.3	LAN Settings.....	430
15.10.4	USB Settings.....	432
15.10.5	Trigger Out.....	432
15.10.6	Firmware Update.....	433
15.11	Serial Bus Analysis.....	434
15.11.1	General.....	434
15.11.2	SPI (Option R&S RTB-K1).....	436
15.11.3	I ² C.....	449
15.11.4	UART (Option R&S RTB-K2).....	459
15.11.5	CAN (Option R&S RTB-K3).....	468
15.11.6	LIN (Option R&S RTB-K3).....	484
15.12	Mixed Signal Option (Option R&S RTB-B1).....	497
15.12.1	Logic Channels.....	497
15.12.2	Parallel Buses.....	503
15.13	Signal Generation (Option R&S RTB-B6).....	508
15.13.1	Function Generator.....	508
15.13.2	Pattern Generator.....	516
15.14	Status Reporting.....	522
15.14.1	STATus:OPERation Register.....	522
15.14.2	STATus:QUESTionable Registers.....	523
16	Maintenance.....	528
16.1	Cleaning.....	528
16.2	Storing and Packing.....	528
16.3	Replacing the Fuse.....	529
16.4	Data Security.....	529
	Annex.....	530
A	Remote Control - Basics.....	530

A.1 SCPI Command Structure.....	530
A.1.1 Syntax for Common Commands.....	530
A.1.2 Syntax for Device-Specific Commands.....	531
A.1.3 SCPI Parameters.....	532
A.1.4 Overview of Syntax Elements.....	535
A.1.5 Structure of a Command Line.....	536
A.1.6 Responses to Queries.....	537
A.2 Command Sequence and Synchronization.....	538
A.2.1 Preventing Overlapping Execution.....	538
A.3 Messages	540
A.3.1 Instrument Messages.....	540
A.3.2 LAN Interface Messages.....	541
B Remote Control - Status Reporting System.....	542
B.1 Structure of a SCPI Status Register.....	542
B.2 Hierarchy of status registers.....	543
B.3 Contents of the Status Registers.....	545
B.3.1 Status Byte (STB) and Service Request Enable Register (SRE).....	545
B.3.2 Event Status Register (ESR) and Event Status Enable Register (ESE).....	546
B.3.3 STATus:OPERation Register.....	547
B.3.4 STATus:QUEStionable Register.....	547
B.4 Application of the Status Reporting System.....	551
B.4.1 Service Request.....	551
B.4.2 Serial Poll.....	551
B.4.3 Query of an instrument status.....	551
B.4.4 Error Queue.....	552
B.5 Reset Values of the Status Reporting System.....	552
List of Commands.....	554

1 Preface

1.1 Safety Information

The R&S RTB2000 digital oscilloscope is designed for measurements on circuits that are only indirectly connected to the mains or not connected at all. It is not rated for any measurement category.

The instrument is rated for pollution degree 2 - for indoor, dry location use where only non-conductive pollution occurs. Temporary conductivity caused by condensation is possible.

The instrument is intended for use in industrial areas. When used in residential areas, radio disturbances caused by the instrument can exceed given limits. Additional shielding can be required.

The instrument must be controlled by personnel familiar with the potential risks of measuring electrical quantities. Observe applicable local or national safety regulations and rules for the prevention of accidents.

Safety information is part of the product documentation. It warns you about the potential dangers and gives instructions how to prevent personal injury or damage caused by dangerous situations. Safety information is provided as follows:

- The "Basic Safety Instructions" in different languages are delivered as a printed brochure with the instrument.
- Throughout the documentation, safety instructions are provided when you need to take care during setup or operation.

WARNING

Risk of injury

Use the instrument in an appropriate manner to prevent electric shock, personal injury, or fire:

- Do not open the instrument casing.
 - Do not use the instrument if you detect or suspect any damage of the instrument or accessories.
 - Do not operate the instrument in wet, damp or explosive atmospheres.
 - Make sure that the instrument is properly grounded.
 - Do not use the instrument to ascertain volt-free state.
 - Do not exceed the voltage limits given in [Chapter 2.2.1.1, "Input Connectors"](#), on page 21.
-

NOTICE**Risk of instrument damage due to inappropriate operating conditions**

An unsuitable operating site or test setup can damage the instrument and connected devices. Before switching on the instrument, observe the information on appropriate operating conditions provided in the data sheet. In particular, ensure the following:

- All fan openings are unobstructed and the airflow perforations are unimpeded. A minimum distance of 10 cm to other objects is recommended.
- The instrument is dry and shows no sign of condensation.
- The instrument is positioned as described in the following sections.
- The ambient temperature does not exceed the range specified in the data sheet.
- Signal levels at the input connectors are all within the specified ranges.
- Signal outputs are connected correctly and are not overloaded.

1.2 Documentation Overview

This section provides an overview of the R&S RTB2000 user documentation.

1.2.1 Manuals and Instrument Help

You find the manuals on the product page at:

www.rohde-schwarz.com/manual/rtb2000

Getting started manual

Introduces the R&S RTB2000 and describes how to set up the product. A printed English version is included in the delivery.

User manual

Contains the description of all instrument modes and functions. It also provides an introduction to remote control, a complete description of the remote control commands with programming examples, and information on maintenance and instrument interfaces. Includes the contents of the getting started manual.

The *online version* of the user manual provides the complete contents for immediate display on the internet.

Instrument help

The help offers quick, context-sensitive access to the functional description directly on the instrument.

Basic safety instructions

Contains safety instructions, operating conditions and further important information. The printed document is delivered with the instrument.

Instrument security procedures manual

Deals with security issues when working with the R&S RTB2000 in secure areas.

Service manual

Describes the performance test for checking the rated specifications, module replacement and repair, firmware update, troubleshooting and fault elimination, and contains mechanical drawings and spare part lists. The service manual is available for registered users on the global Rohde & Schwarz information system (GLORIS, <https://gloris.rohde-schwarz.com>).

1.2.2 Data Sheet and Brochure

The data sheet contains the technical specifications of the R&S RTB2000. It also lists the options with their order numbers and optional accessories. The brochure provides an overview of the instrument and deals with the specific characteristics.

See www.rohde-schwarz.com/brochure-datasheet/rtb2000

1.2.3 Calibration Certificate

The document is available on <https://gloris.rohde-schwarz.com/calcert>. You need the device ID of your instrument, which you can find on a label on the rear panel.

1.2.4 Release Notes and Open Source Acknowledgment

The release notes list new features, improvements and known issues of the current firmware version, and describe the firmware installation. The open source acknowledgment document provides verbatim license texts of the used open source software.

See www.rohde-schwarz.com/firmware/rtb2000. The open source acknowledgment document can also be read directly on the instrument.

1.3 Conventions Used in the Documentation**1.3.1 Typographical Conventions**

The following text markers are used throughout this documentation:

Convention	Description
"Graphical user interface elements"	All names of graphical user interface elements on the screen, such as dialog boxes, menus, options, buttons, and softkeys are enclosed by quotation marks.
[Keys]	Key and knob names are enclosed by square brackets.
Filenames, commands, program code	Filenames, commands, coding samples and screen output are distinguished by their font.
<i>Input</i>	Input to be entered by the user is displayed in italics.
Links	Links that you can click are displayed in blue font.
"References"	References to other parts of the documentation are enclosed by quotation marks.

1.3.2 Conventions for Procedure Descriptions

When operating the instrument, several alternative methods may be available to perform the same task. In this case, the procedure using the touchscreen is described. Any elements that can be activated by touching can also be clicked using an additionally connected mouse. The alternative procedure using the keys on the instrument or the on-screen keyboard is only described if it deviates from the standard operating procedures.

The term "select" may refer to any of the described methods, i.e. using a finger on the touchscreen, a mouse pointer in the display, or a key on the instrument or on a keyboard.

1.3.3 Notes on Screenshots

When describing the functions of the product, we use sample screenshots. These screenshots are meant to illustrate as many as possible of the provided functions and possible interdependencies between parameters. The shown values may not represent realistic usage scenarios.

The screenshots usually show a fully equipped product, that is: with all options installed. Thus, some functions shown in the screenshots may not be available in your particular product configuration.

2 Getting Started

2.1 Preparing for Use

2.1.1 Unpacking and Checking the Instrument

1. Inspect the package for damage.

If the packaging material shows any signs of stress, notify the carrier who delivered the instrument.

2. Carefully unpack the instrument and the accessories.
3. Check the equipment for completeness. See section "[Delivery contents](#)" on page 17.
4. Check the equipment for damage.
If there is damage, or anything is missing, immediately contact the carrier as well as your distributor. Make sure not to discard the box and packing material.



Packing material

Retain the original packing material. If the instrument needs to be transported or shipped later, you can use the material to protect the control elements and connectors.

Delivery contents

The delivery package contains the following items:

- R&S RTB2000 digital oscilloscope
- R&S RT-ZP03 probes (2x for R&S RTB2002; 4x for R&S RTB2004)
- Country-specific power cable
- Printed "Getting Started" manual
- Printed "Basic Safety Instructions" brochure

2.1.2 Positioning the Instrument

The instrument is designed for use under laboratory conditions. It can be used in standalone operation on a bench top or can be installed in a rack.

For standalone operation, place the instrument on a horizontal bench with even, flat surface. The instrument can be used in horizontal position, or with the support feet on the bottom extended.

The instrument can be installed in a 19" rack mount using a rack mount kit. The order number of the rack mount kit is given in the data sheet. The installation instructions are part of the rack mount kit.

⚠ CAUTION

Risk of injury if feet are folded out

The feet can fold in if they are not folded out completely or if the instrument is shifted. This can cause damage or injury.

- Fold the feet completely in or out to ensure stability of the instrument. Never shift the instrument when the feet are folded out.
- When the feet are folded out, do not work under the instrument or place anything underneath.
- The feet can break if they are overloaded. The overall load on the folded-out feet must not exceed 200 N.

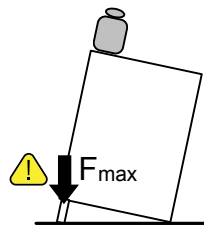

NOTICE

Risk of instrument damage due to overheating

An insufficient airflow can cause the R&S RTB2000 to overheat, which can impair the measurement results, disturb the operation, and even cause damage.

- Ensure that all fan openings are unobstructed and that the airflow perforations are unimpeded. The minimum distance to a wall is 10 cm.
- When placing several instruments side by side, keep a minimum distance of 20 cm between the instruments. Ensure that the instruments do not draw in the preheated air from their neighbors.
- When mounting the instrument in a rack, observe the instructions of the rack manufacturer to ensure sufficient airflow and avoid overheating.

2.1.3 Starting the Instrument

2.1.3.1 Powering On

The R&S RTB2000 can be used with different AC power voltages and adapts itself automatically to it.

The nominal ranges are:

- 100 V to 240 V AC at 50 Hz to 60 Hz
- 0.95 A to 0.5 A
- max. 60 W

CAUTION

Risk of injury

Connect the instrument only to an outlet that has a ground contact.

Do not use an isolating transformer to connect the instrument to the AC power supply.

1. Connect the power cable to the AC power connector on the rear panel of the R&S RTB2000.
2. Connect the power cable to the socket outlet.
3. Switch the main power switch at the rear of the instrument to position I.
The [Standby] key lights up. The key is located in the bottom left corner of the front panel.

You can leave the main power switch on to preserve your last instrument settings. To disconnect from power supply, power off the instrument.

2.1.3.2 Starting Up and Shutting Down

To start up the instrument

1. Make sure that the R&S RTB2000 is connected to the AC power supply and the main power switch on the rear panel is in position I.
2. Press the [Standby] key. The key is located in the bottom left corner of the front panel.

The instrument performs a system check and starts the firmware. If the previous session was terminated regularly, the oscilloscope uses the last settings.

Table 2-1: Colors of the [Standby] key

Green	Instrument is on: firmware is working
Yellow	Standby: instrument is off, main power switch is on



Warm-up and prepare the instrument

Make sure that the instrument has been running and warming up before you start the self-alignment and the measurements. The minimum warm-up time is about 20 min.

To shut down the instrument to standby state

- ▶ Press the [Standby] key.

All current settings are saved, and the software shuts down. Now it is safe to power off the instrument.

2.1.3.3 Powering Off

Powering off is required only if the instrument must be disconnected from all power supplies.

1. If the instrument is running, press the [Standby] key on the front panel to shut down the instrument.
2. Switch the main power switch at the rear of the instrument to position 0.
3. Disconnect the AC power cable from the AC power supply.

NOTICE

Risk of losing data

If you switch off the running instrument using the rear panel switch or by disconnecting the power cord, the instrument loses its current settings. Furthermore, program data can be lost.

Press the Standby key first to shut down the application properly.

2.1.3.4 EMI Suppression

Electromagnetic interference (EMI) may affect the measurement results.

To suppress generated electromagnetic interference (EMI):

- Use suitable shielded cables of high quality. For example, use double-shielded RF and LAN cables.
- Always terminate open cable ends.
- Note the EMC classification in the data sheet.

2.2 Instrument Tour

2.2.1 Front Panel

Figure 2-1 shows the front panel of the R&S RTB2000. The function keys are grouped in functional blocks to the right of the display.

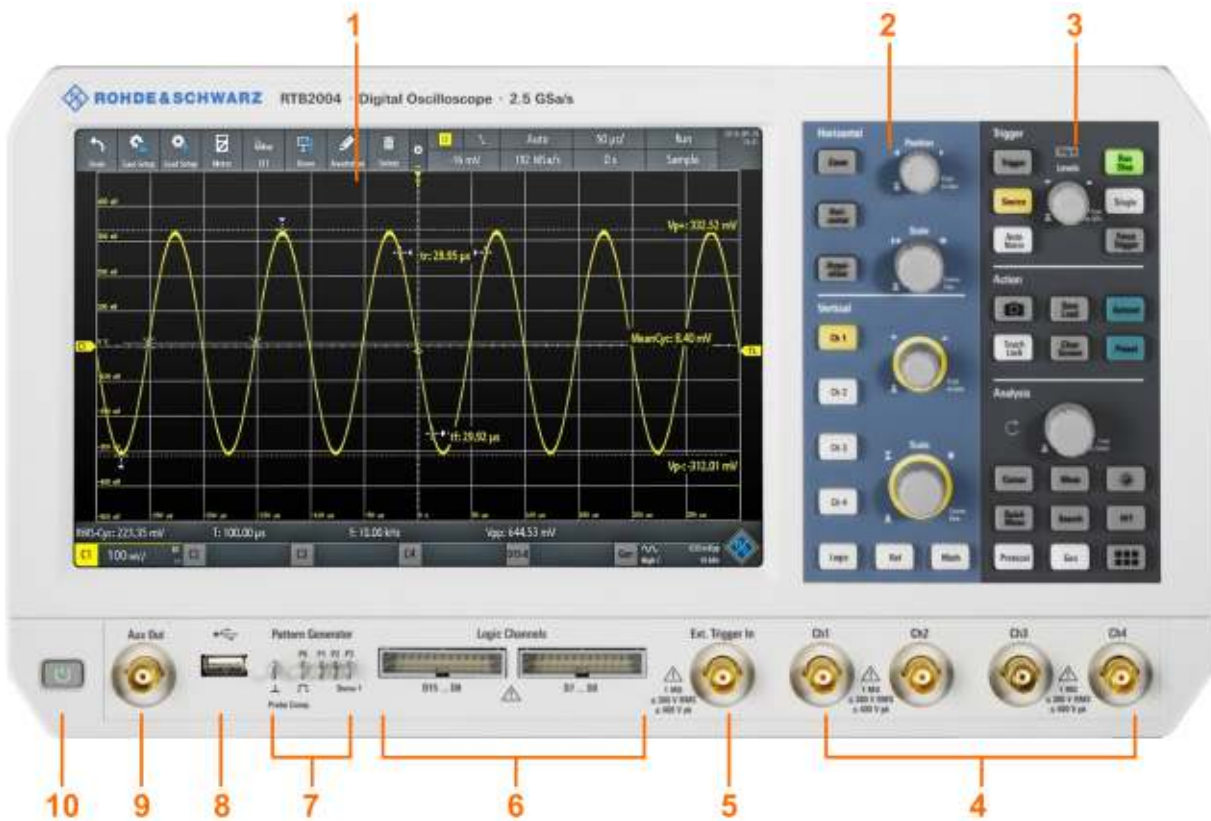
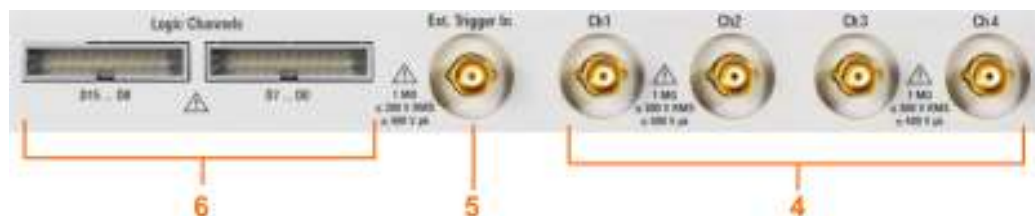

Figure 2-1: Front panel of R&S RTB2004 with 4 input channels

- 1 = Display
- 2 = Horizontal and vertical setup controls
- 3 = Trigger settings, action and analysis controls
- 4 = Analog input channels (2 channels at R&S RTB2002, 4 channels at R&S RTB2004)
- 5 = External trigger input
- 6 = Logic probe connectors (option R&S RTB-B1)
- 7 = Connectors for probe compensation and optional pattern generator (R&S RTB-B6)
- 8 = USB connector
- 9 = Aux Out connector
- 10 = [Standby] key

2.2.1.1 Input Connectors



BNC inputs (4 and 5)

The R&S RTB2000 has two or four channel inputs (4) to connect the input signals. The external trigger input (5) is used to control the measurement by an external signal. The trigger level can be set from -5 V to 5 V.

The input impedance of all BNC inputs is 1 M Ω .

WARNING

Risk of electrical shock - maximum input voltages

The maximum input voltage on *channel inputs* must not exceed 400 V (peak) and 300 V (RMS).

For the *external trigger input*, the maximum input voltage is 400 V (peak) and 300 V (RMS).

Transient overvoltages must not exceed 400 V (peak).

Voltages higher than 30 V (RMS) or 42 V (peak) or 60 V DC are regarded as hazardous contact voltages. When working with hazardous contact voltages, use appropriate protective measures to preclude direct contact with the measurement setup:

- Use only insulated voltage probes, test leads and adapters.
- Do not touch voltages higher than 30 V (RMS) or 42 V (peak) or 60 V DC.

CAUTION

Risk of injury and instrument damage

The instrument is not rated for any measurement category. When measuring in circuits with transient overvoltages of category II, III or IV circuits, make sure that no such overvoltages reach the R&S RTB2000 input. Therefore, use only probes that comply with DIN EN 61010-031. When measuring in category II, III or IV circuits, always insert a probe that appropriately reduces the voltage so that no transient overvoltages higher than 400 V (peak) are applied to the instrument. For detailed information, refer to the documentation and safety information of the probe manufacturer.

Explanation: According to section AA.2.4 of EN 61010-2-030, measuring circuits without any measurement category are intended for measurements on circuits which are not directly connected to the mains.

Logic probe (6)

The connectors for logic channels can be used if the Mixed Signal Option R&S RTB-B1 is installed. The option provides connectors for two logical probes with 8 digital channels each (D0 to D7 and D8 to D15).

The maximum input voltage is 40 V (peak) at 100 k Ω input impedance. The maximum input frequency for a signal with the minimum input voltage swing and medium hysteresis of 800 mV (V_{pp}) is 300 MHz.

2.2.1.2 Other Connectors on the Front Panel

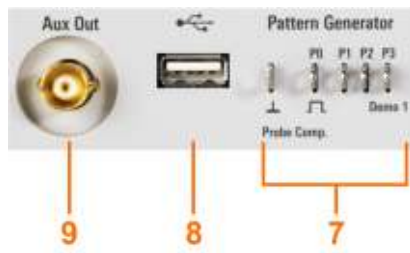



[Pattern Generator] (7)

Connectors for the pattern generator P0, P1, P2, P3.

The "Demo 1" signal is intended for demonstration purposes.

[Probe Comp.] (7)

Probe compensation terminal to support adjustment of passive probes to the oscilloscope channel.

-  Square wave signal for probe compensation.
-  Ground connector for probes.

[USB] type A (8)

USB 2.0 type A interface to connect a mouse or a keyboard, or a USB flash drive for storing and reloading instrument settings and measurement data, and to update the firmware.

[Aux Out] (9)

Multi-purpose BNC output that can function as pass/fail and trigger output, output of 10 MHz reference frequency, and as waveform generator (with option R&S RTB-B6).

2.2.2 Rear Panel

[Figure 2-2](#) shows the rear panel of the R&S RTB2000 with its connectors.



Figure 2-2: Rear panel view of R&S RTB2000

- 1 = LAN connector
- 2 = USB connector, type B
- 3 = AC power supply connector and main power switch
- 4 = Kensington lock slot to secure the instrument against theft
- 5 = Loop for lock to secure the instrument against theft
- 6 = not used

[LAN] (1)

8-pin connector RJ-45 used to connect the instrument to a Local Area Network (LAN). It supports up to 1 Gbit/s.

[USB] type B (2)

USB 2.0 interface of type B (device USB) for remote control of the instrument.

Note: Electromagnetic interference (EMI) can affect the measurement results. To avoid any impact, use only USB connecting cables with a maximum length of 1 m.

AC supply: mains connector and main power switch (3)

The instrument supports a wide range power supply. It automatically adjusts to the correct range for the applied voltage. There is no line voltage selector.

The AC main power switch disconnects the instrument from the AC power line.

3 Operating Basics

3.1 Display Overview

The touchscreen display of the instrument shows the waveforms and measurement results, and also information and everything that you need to control the instrument.

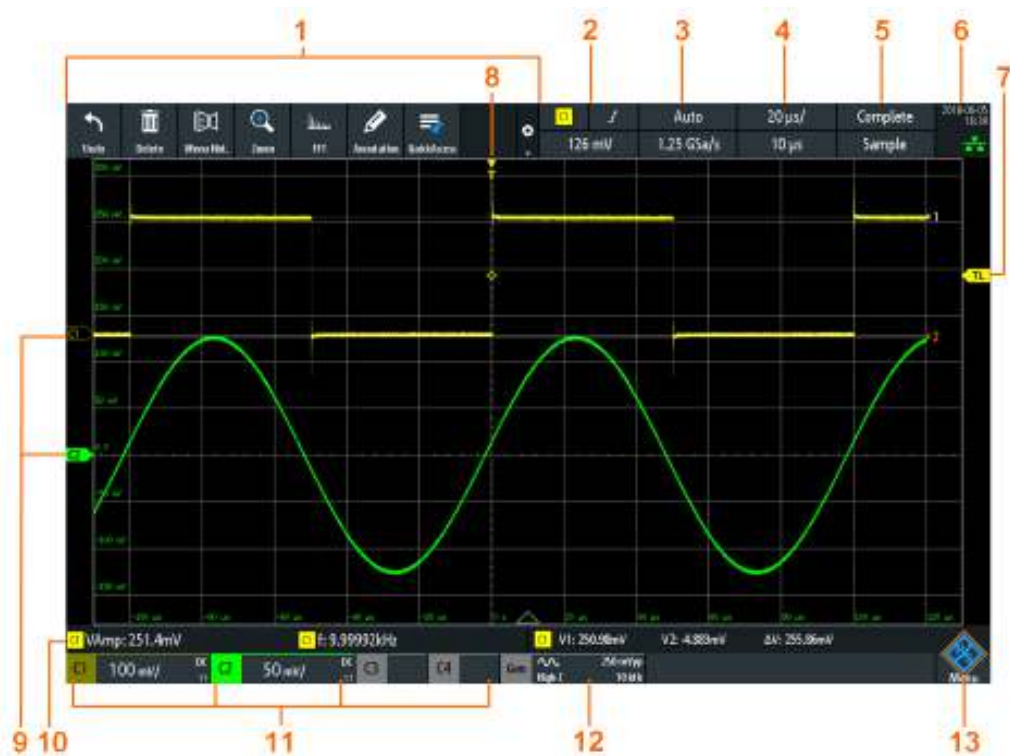



Figure 3-1: Display of the R&S RTB2000 with 4 channels

- 1 = Toolbar
- 2 = Trigger source, main trigger parameter (here: slope for edge trigger), trigger level
- 3 = Trigger mode and sample rate
- 4 = Horizontal scale (time scale) and horizontal position
- 5 = Acquisition status and acquisition mode
- 6 = Date, time, education mode if active (here: off), LAN connection status (green = connected, grey = not connected, yellow = connecting)
- 7 = Trigger level marker, has the color of the trigger source
- 8 = Trigger position marker, has the color of the trigger source
- 9 = Channel markers indicate the ground levels; channel C2S is selected, i.e. it has the focus
- 10 = Measurement results (here: automatic measurements on the left, cursor measurements on the right)
- 11 = Vertical settings of active analog channels: vertical scale, bandwidth limitation (no indicator = full bandwidth, B_W = limited frequency), coupling (AC, DC, ground), probe attenuation. Channel 2 is selected.
- 12 = Waveform generator settings (requires option R&S RTB-B6)
- 13 = Menu button

3.2 Selecting the Application

The "Apps Selection" dialog provides fast access to all available applications.

- ▶ There are several ways to open the "Apps Selection" dialog:
 - Press the  [Apps Selection] key.
 - Tap the "Menu" rhomb icon in the lower right corner of the screen.



- Scroll down.
- Select "Apps".

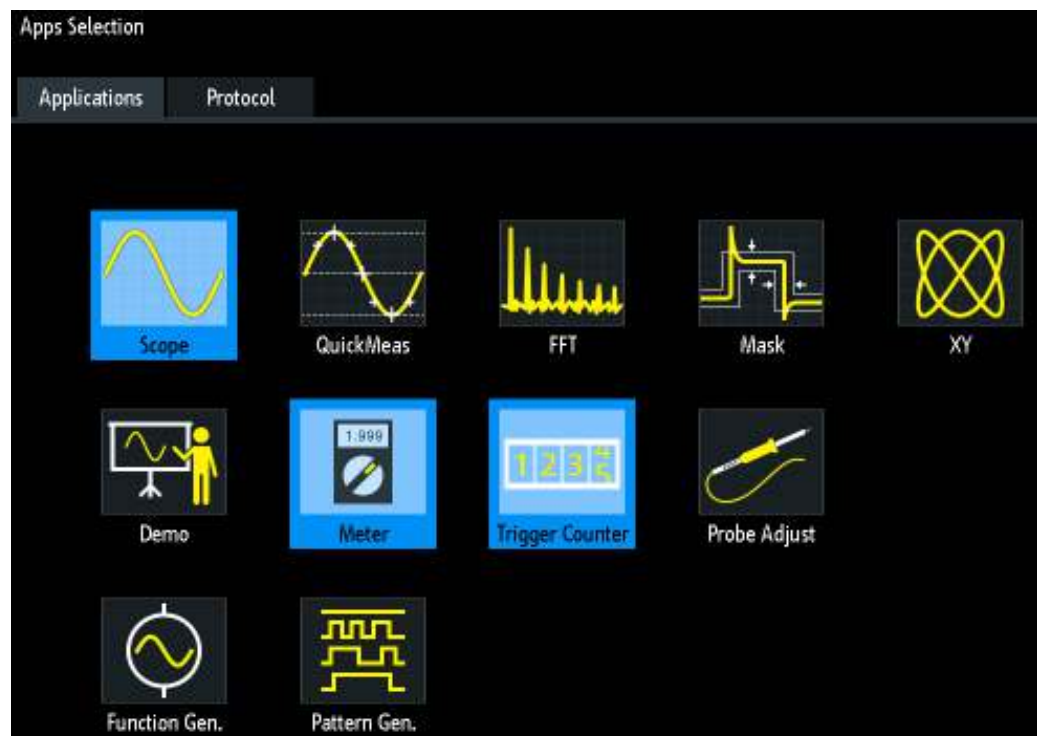

3.3 Using the Touchscreen

3.3.1 Accessing Functionality Using the Main Menu

Using the touchscreen of the R&S RTB2000 is as easy as using your mobile phone. To open the main menu, tap the "Menu" button - that is the R&S logo in the right bottom corner of the display.

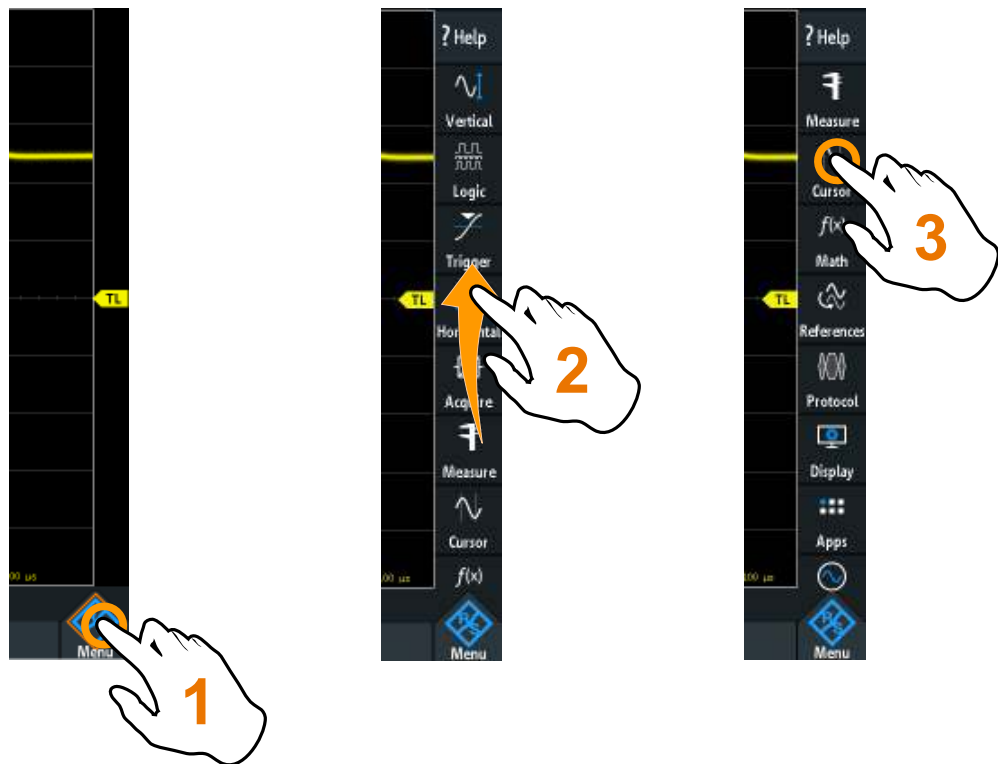

Figure 3-2: Open the main menu and select a menu item

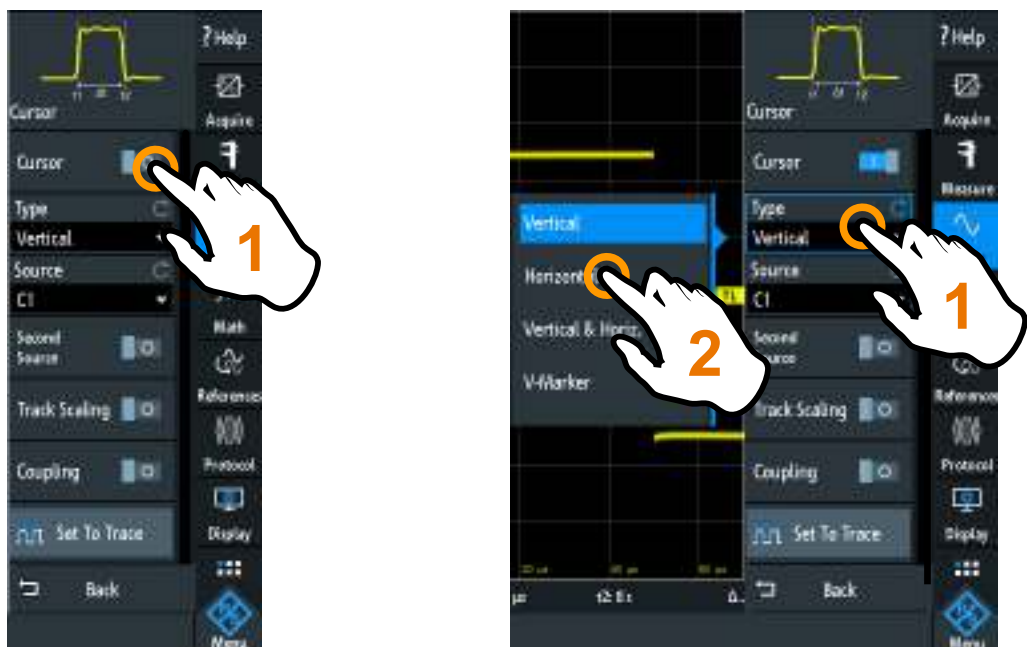

Figure 3-3: Switch on or off (left) and select a parameter value (right)

► To close the menu:

Tap "Back", or tap into the diagram outside the menu.

3.3.2 Accessing Functionality Using Shortcuts

The labels in information bar at the top of the display, the channel labels and also the results at the bottom provide shortcuts to the most important settings. If you tap a label, a short menu opens, the keypad for numerical entry, the setting toggles, or the corresponding menu opens. The response depends on the selected parameter.



Figure 3-4: Short menus for channel (left) and trigger slope (right)



From the short menu, you can also open the corresponding comprehensive menu. You can also switch off the channels.

3.3.3 Entering Data

To enter exact numerical values, the instrument provides an on-screen keypad. For text input, the on-screen keyboard works in the same way.



Figure 3-5: Enter numerical value and unit

3.3.4 Using Gestures

Drag one finger



Drag *horizontally* in the diagram to change the horizontal position of all waveforms. In frequency domain, the center frequency is changed.



Drag *vertically* in the diagram to change the vertical position of the selected waveform.

To adjust the vertical position of each waveform, the trigger level, and the trigger position, drag the corresponding marker on the display.

To drag a cursor line, tap the line and drag it to the required position.



Swipe one finger

Swipe in the menu to scroll it.



Spread and pinch two fingers

Spread or pinch two fingers in *vertical* direction to change the vertical scale of the selected waveform.

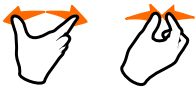

Spread or pinch two fingers in *horizontal* direction to change the horizontal scale of all waveforms. In frequency domain, the frequency span is changed.

Swipe two fingers



If the history option R&S RTB-K15 is installed, swipe two fingers in the diagram to scrolls through the history segments.

3.4 Front Panel Keys

For an overview of the front panel keys, see [figure 2-1 on page 21](#).

The keys and knobs at the front panel are grouped in functional blocks:

- Horizontal section: see [Chapter 4.4.1, "HORIZONTAL Controls"](#), on page 49.
- Vertical section: see [Chapter 4.3.1, "VERTICAL Controls"](#), on page 39.
- Trigger section: see [Chapter 5.1, "Trigger Controls"](#), on page 58
- Action section, see [Chapter 3.4.1, "Action Controls"](#), on page 30.
- Analysis section, see [Chapter 3.4.2, "Analysis Controls"](#), on page 31.

3.4.1 Action Controls

The Action keys set the instrument to a defined state, and provide save and load functions.



[Camera]

Saves screenshots, waveforms and/or settings according to the configuration in [Save Load] > "onetouch".

[Save Load]

Opens the "File" menu, where you can:

- Save instrument settings, waveforms, reference waveforms, and screenshots
- Restore (load) data which were saved before
- Import and export settings and reference waveforms
- Configure the screenshot output
- Configure the behavior of the [Camera] key

[Touch Lock]

Locks the touchscreen to prevent unintended use. When the touchscreen is off, the key is illuminated. Press again to unlock the touchscreen.

[Clear Screen]

Deletes all waveforms, annotations and the measurement results of deleted waveforms. All settings remain unchanged.

Remote command:

[DISPlay:CLEAr\[:SCReen\]](#) on page 422

3.4.2 Analysis Controls

The controls in the [Analysis] functional block open various menus for signal analysis.

**[Navigation]**

The function of this universal rotary knob depends on the usage context:

- If selection menu is open: turn the knob to select a value.
- If a numerical value is selected in the menu, and the keypad is closed: turn the knob to set a value.
- If the cursors are selected, press the key to select a cursor line. Turn the knob to change the position of the selected cursor line.
- If an on-screen keypad or on-screen keyboard is open: turn the knob until the required character is highlighted, then press the knob to apply the selection.
- Otherwise: turn the knob to set the waveform intensity, or press the knob to set the intensity to 50%.

[Cursor]

Enables the cursor with the last configured cursor setup. The second keypress opens the "Cursor" menu. If the menu is open, pressing the key turns off the cursor and closes the menu.

[Meas]

Opens the "Measure" menu, where you can configure up to 4 parallel measurements. Available measurement types depend on the type of the selected waveform.

[Intensity]

Opens the "Intensities" menu to adjust the luminosity of display elements and the persistence.

[QuickMeas]

Displays the results of basic automatic measurements for the selected channel below the grid and directly on the waveform.

Press the key to stop quick measurements.

Note: Channels other than the selected one are switched off in quick measurement mode. When you activate quick measurements, cursor measurements are automatically deactivated. Deactivate quick measurements before selecting the cursors.

[Search]

Enables the search with the last configured setup. The second keypress opens the "Search" menu, where you can perform a search for various events in an acquisition - for example, peaks or specific width conditions - and analyze the search results.

[FFT]

Activates the spectrum analysis functions with the last configured setup. The second keypress opens the "FFT" menu.

To deactivate spectrum analysis, press the [FFT] key until the time domain waveform is displayed.

[Protocol]

Opens the "Bus" menu, which contains the configuration of serial and parallel buses and the settings for decoding the signals. Key function requires at least the MSO option R&S RTB-B1 or one of the serial protocol options. See data sheet for available options.

[Gen]

Opens the "Function Generator" menu, where you can create various waveforms. Key function requires option R&S RTB-B6.

[Apps Selection]

Opens the "Apps Selection" dialog where you can select the required application or protocol for your task, for example, mask testing or CAN protocol.

3.5 Using the Toolbar

The toolbar at the top of the display provides direct access to important control and measurement functions. The selected function is highlighted. By default, the toolbar shows the most frequently used functions. You can configure the content of the toolbar so that only the required functions are displayed..

Some of the toolbar functions are one-click actions. These actions are performed immediately when you tap the icon. Other toolbar functions are interactive actions. When you tap an interactive action, a message informs you what to do next.

Configuring the Toolbar

1. Tap the "Toolbar Setup" icon.



2. Disable the functions that you do not need.
3. Tap the functions that you need. You can select maximum 8 functions.

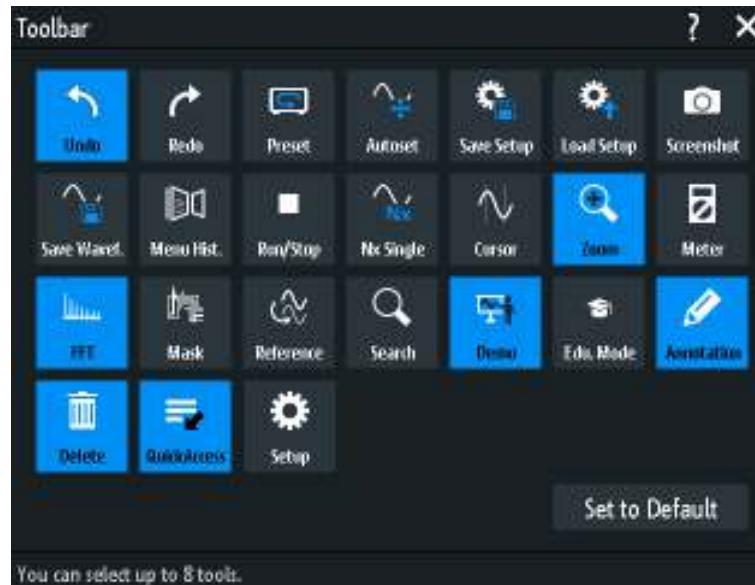

4. Close the dialog box.

3.6 Quick Access

If the measurement task requires to change the settings from different menus repeatedly, you can use the "QuickAccess". The "QuickAccess" is a user-defined menu, which can be added to the toolbar.

To configure the "QuickAccess" menu:

1. Add the "QuickAccess" icon to the toolbar as described in ["Configuring the Toolbar"](#) on page 32.
2. Add the required settings and functions to the "QuickAccess" menu:
 - a) Open the menu that contains the setting.
 - b) Drag the setting from the menu and drop it on the diagram.
The setting is added to the "QuickAccess".

- c) Repeat steps a) and b) for each setting and function that you need for the measurement task.

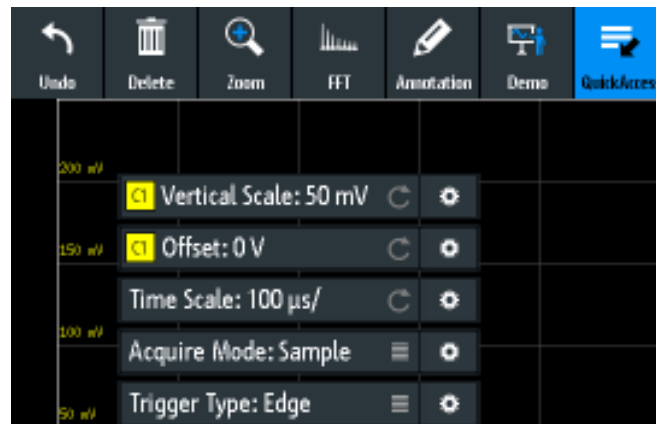

3. To remove unwanted settings and functions:
 - a) Tap the  "Settings" icon of the function.
 - b) To delete the selected setting or function, tap "Delete".
 - c) To delete the complete "QuickAccess" menu, tap "Delete All".
- To show or hide the "QuickAccess" menu, tap the "QuickAccess" icon on the toolbar.

3.7 Menu History

The menu history is another way to speed up and simplify the usage of the R&S RTB2000. The menu history is also a user-defined menu, which can be added to the toolbar. It logs all menus that you used during the current session.

1. Add the "Menu Hist." icon to the toolbar as described in ["Configuring the Toolbar"](#) on page 32.
2. Open some menus and set up parameters.
3. Tap the "Menu Hist." icon on the toolbar.
4. Tap the menu that you want to open.

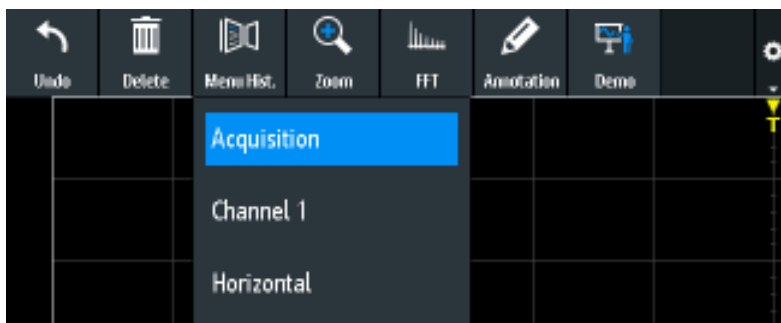

3.8 Getting Help

In most menus and dialogs, graphics explain the meaning of the selected setting. For further information, you can open the help, which provides functional description of selected setting.

To open the help window

1. Tap the "Menu" icon in the lower right corner of the screen.
2. Tap "Help" on the top of the main menu.
3. Tap the setting for which you need information.

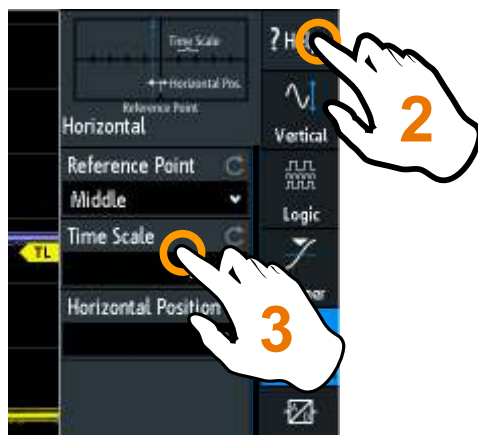

To close the help window

- ▶ Tap "Help" on the top of the main menu, or tap the "Close" icon in the upper right corner of the help window.

4 Waveform Setup

This chapter describes how to connect and set up probes, to adjust the horizontal and vertical settings, and to control the acquisition.

4.1 Connecting Probes and Displaying a Signal

NOTICE

Risk of instrument damage

Make sure to set the attenuation factor on the instrument according to the probe being used. Otherwise, the measurement results do not reflect the actual voltage level, and you might misjudge the actual risk.

The attenuation of the probes that are delivered with the instrument, and the default attenuation factor of the instrument are 10:1. If you use only the delivered probes and did not change the attenuation factor, no attenuation adjustment is required.

1. Connect the probes first to the channel inputs, and then to the DUT.
2. Tap the label of the used channel in the bottom line of the display.

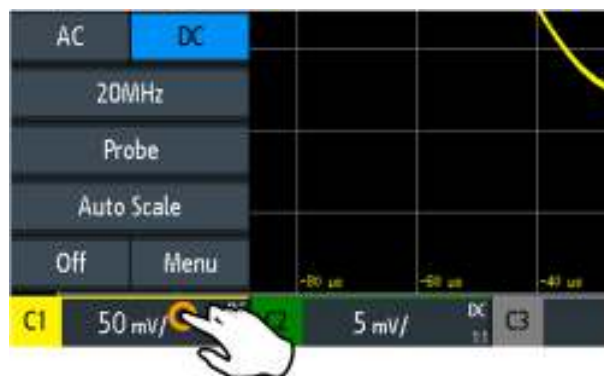

3. Tap "Probe".
4. Select the attenuation factor of the probe.
The probe's attenuation factor is indicated on the probe.
Note: If you measure current using a shunt resistor as a current sensor, you have to multiply the V/A-value of the resistor by the attenuation of the probe. For example, if a 1 Ω resistor and a 10:1 probe is used, the V/A-value of the resistor is 1 V/A. The attenuation factor of the probe is 0.1, and the resulting current probe attenuation is 100 mV/A.
5. If you connect several probes, repeat steps 2 to 4 for the remaining channels.
6. Press the [Autoset] key.

[Autoset]

Analyzes the enabled analog channel signals, and adjusts the horizontal, vertical, and trigger settings to display stable waveforms.

In particular, autoset adjusts the following settings:

- Vertical settings of analog channels: vertical scale, offset, and position
- Horizontal settings: time scale (also in Zoom, Quickmeas, FFT, and XY mode), horizontal position of the trigger
- Trigger: set to automatic trigger mode and edge trigger type (except for pattern trigger), trigger source to active existing signal, automatic hysteresis, trigger coupling to DC, switch off HF / noise reject and hold off
- Reference and math waveforms are switched off
- Annotations are deleted
- Menus are closed

Autoset does not switch off analog and vertical channels, and it does not change the instrument mode, cursor, measurement, and waveform generator settings.

To adjust only vertical settings of one channel, use the "Auto Scale" function in the channel short menu, see [Chapter 4.3.2, "Short Menu for Analog Channels"](#), on page 40.

Remote command:

[AUToscale](#) on page 290

[Preset]

Resets the instrument to the scope mode and to default state, without analyzing the signal. The user-defined configuration, measurements and other settings are removed and all channels and waveforms, except for channel 1, are disabled.

Preset does not change the display settings.

See also: [Chapter 10.3, "Reset"](#), on page 172.

Remote command:

[*RST](#) on page 288

4.2 Adjusting Passive Probes

Passive probes, which are delivered with the instrument, are already pre-compensated to the R&S RTB2000 characteristics, and a compensation procedure is not required.

If you use another passive probe, it is necessary to compensate it when it is connected to the instrument the first time. Compensation matches the probe cable capacitance to the oscilloscope input capacitance to assure good amplitude accuracy from DC to upper bandwidth limit frequencies. A poorly compensated probe reduces the performance of the probe-oscilloscope system and introduces measurement errors resulting in distorted waveforms and inaccurate results.

Two connector pins for compensation are located at the front panel. The left pin is on ground level. The next pin supplies a square wave signal for the adjustment.

1. Press the  [Apps Selection] key.

2. Tap "Probe Adjust".
3. Follow the instructions of the wizard. It guides you through the compensation process.
Use the compensation trimmer of the probe to get optimum square wave response. For details, refer to the documentation of your probe.

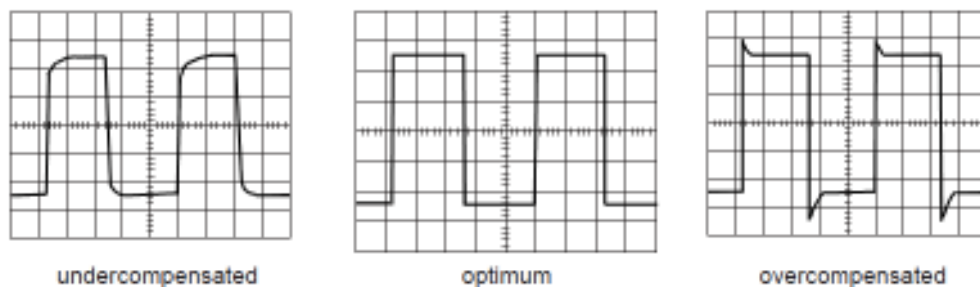

4.3 Vertical Setup

The controls and parameters of the vertical system adjust the vertical scale and position of the waveform, and the waveform display. The probe settings also belong to the vertical setup.

The channel labels at the bottom of the display show the basic vertical settings: vertical scale (for example, channel 3 in the figure below: 500 mV/div), coupling (AC), probe attenuation (10:1), and bandwidth (if limited). Clipping of a waveform is indicated by orange arrows. The label of the selected channel has a brighter colored line on the top.

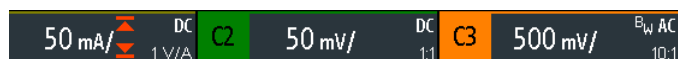

Figure 4-1: Channel labels. Channel 3 is selected. Channel 1 waveform is clipped.

There are several ways to adjust vertical settings:

- Use the controls in the Vertical functional block of the front panel to select the channel, to scale the waveform, and to set the position.
- Drag one finger vertically on the screen to change the position of the selected channel waveform.
- Spread or pinch two fingers in vertical direction to change the vertical scale of the selected waveform.
- Use the short menu to adjust coupling and the probe, and to set the vertical scale automatically.
- Use the comprehensive menu to adjust all vertical settings.

4.3.1 VERTICAL Controls



[Ch <n>]

For each analog channel, a channel key is available. The key is illuminated in the channel color, if the channel is on.

The effect of the keypress depends on state of the channel:

- If channel is off: Turns on the channel and selects it. The rotary knobs alongside light up in the channel color.
- If the channel is on and in focus (selected): Opens the corresponding channel menu.
- If the channel is on but not in focus (not selected): Selects the channel waveform.
- If the channel is selected, and the menu is open: Pressing the key turns off the channel.

Remote command:

[CHANnel<m>:STATe](#) on page 292

[Offset/Position (upper knob)]

The upper vertical knob adjusts the following, depending on the selected waveform:

- Offset or position of an analog channel (adjustable: main menu > "Vertical"). The visual effect is the same. While the offset sets a voltage, position is a graphical setting given in divisions.
- Vertical position of a math or reference waveform, serial bus, or logic pod

The knob lights up in the color of the selected waveform. Turn clockwise to move up the waveform. Pressing the key has the following effects:

- Analog channels, math waveforms, and buses: sets the value to zero.
- Reference waveforms: sets to original position or to 0 divisions.
- FFT and single bits of a pod: set to default value.
- Pods: set to the center of the display.

Remote command:

[CHANnel<m>:POSition](#) on page 293

[CHANnel<m>:OFFSet](#) on page 293

[CALCulate:MATH<m>:POSition](#) on page 320

[REFCurve<m>:VERTical:POSition](#) on page 323

[Scale]

Sets the vertical scale in Volts per division to change the displayed amplitude of the selected waveform. For analog waveforms, the scale value is shown in the waveform label at the bottom. The knob lights up in the color of the selected waveform.

Turn [Scale] clockwise to stretch the waveform. Doing so, the scale value V/div decreases. Press the knob to toggle between fine and coarse adjustment.

To get the maximum resolution of the waveform amplitude, make sure that the waveforms cover most of the screen's height.

Remote command:

[CHANnel<m>:SCALE](#) on page 292

[CALCulate:MATH<m>:SCALE](#) on page 320

[REFCurve<m>:VERTical:SCALE](#) on page 324

[Logic]

Enables the logic channels. The second keypress opens the menu, where you can select and configure digital channels for analysis. If the menu is open, pressing the key disables the logic channels.

Key function requires MSO option R&S RTB-B1.

Logic analyzer functions are described in [Chapter 13, "Logic Analyzer \(Option R&S RTB-B1, MSO\)"](#), on page 250.

[Ref]

Displays the reference waveforms with their last configuration. The second keypress opens the menu, where you can select, create, save and load reference waveforms. If the menu is open, pressing the key disables the reference waveforms.

Reference waveforms are described in [Chapter 6.3, "Reference Waveforms"](#), on page 83.

[Math]

Displays the math waveforms with their last configuration. A math waveform is a waveform that is calculated from the captured data. The second keypress opens the menu, where you can activate and configure math waveforms, and save and load equation sets. If the menu is open, pressing the key disables the math waveforms.

Mathematics is described in [Chapter 6.2, "Mathematics"](#), on page 78.

4.3.2 Short Menu for Analog Channels

To adjust the probe and the coupling, you can use the short menu. Here you can also open the comprehensive menu, and switch off the channel.

- ▶ To open the short menu for a channel, tap the channel label in the bottom line of the display.

If the channel was not selected, tap twice: Once to select the waveform, and next to open the short menu.

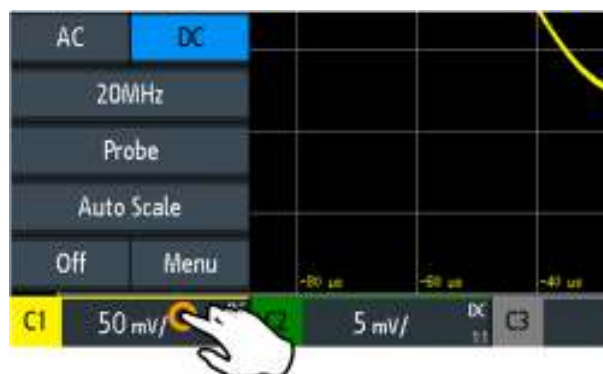

Functions in the short menu:

- "AC | DC": see ["Coupling"](#) on page 43.
- "<current bandwidth>" ("20MHz" in the above example): see ["Bandwidth"](#) on page 43.
- "Probe": opens the "Probe" menu, see [Chapter 4.3.4, "Probe Settings"](#), on page 45.
- "Auto Scale": analyzes the selected channel signal and adjusts the vertical scale. This function is only available in the channel short menu.
- "Off": turns off the channel.
- "Menu": opens the channel menu.

4.3.3 Vertical Settings

The comprehensive "Vertical" menu contains all vertical settings.

1. To open the "Vertical" menu:
 - a) Open the main menu.
 - b) Select "Vertical"
2. Select the parameter that is assigned to the upper vertical knob: "Offset" or "Position".
3. Open the channel menu.

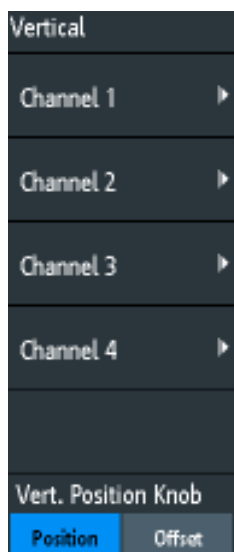

- ▶ To open the channel menu directly, press the corresponding channel key. If the channel was active but not selected, press twice: Once to select the waveform, and next to open the short menu.



Figure 4-2: Channel menu, split into two halves

Vert. Position Knob

Selects the parameter to be changed with the [Offset/Position (upper knob)]: "Offset" or "Position". By default, position is set. [Preset] does not affect the assignment.

Channel <n>

Opens the channel menu.

State

Switches the selected channel on or off.

Remote command:

[CHANnel<m>:STATe](#) on page 292

Coupling

Selects the input coupling, which influences the signal path between input connector and the following internal signal stage. The current coupling of each channel is shown in the waveform labels below the grid.

- "AC" AC coupling is useful if the DC component of a signal is of no interest. AC coupling blocks the DC component of the signal so that the waveform is centered on zero volts.
- "DC" With DC coupling, the input signal passes unchanged, all signal components are shown.

Remote command:

[CHANnel<m>:COUPling](#) on page 293

Bandwidth

Selects the bandwidth limit. At full bandwidth, all frequencies in the specified range of the instrument are acquired and displayed accurately with less than 3 dB attenuation. Full bandwidth is used for most applications.

To reduce noise, you can set a frequency limit. Higher frequencies are removed from the signal. Limited bandwidth is indicated by "B_w" in the waveform label.

For analog applications, the highest signal frequency determines the required oscilloscope bandwidth. The oscilloscope bandwidth should be at least 3 times higher than the maximum frequency included in the analog test signal to measure the amplitude without aliasing.

Most test signals are more complex than a simple sine wave and include several spectral components. A digital signal, for example, is built up of several odd harmonics. For digital signals, the oscilloscope bandwidth should be at least 5 times higher than the clock frequency to be measured.

The oscilloscope is not an autonomous system. You need a probe to measure the signal, and the probe has a limited bandwidth, too. The combination of oscilloscope and probe creates a system bandwidth. To reduce the effect of the probe on the system bandwidth, the probe bandwidth should exceed the bandwidth of the oscilloscope, the recommended factor is 1.5 x oscilloscope bandwidth.

Remote command:

[CHANnel<m>:BANDwidth](#) on page 294

Vertical Scale

Sets the vertical scale in Volts per division to change the displayed amplitude of the selected waveform. The current value is shown in the waveform label below the grid.

Vertical scale directly affects the resolution of the waveform amplitude. To get the full resolution of the ADC, set up the waveforms to cover most of the height of the diagram.

Remote command:

[CHANnel<m>:SCALe](#) on page 292

Offset

Sets the offset voltage, which corrects an offset-affected signal. The vertical center of the selected channel is shifted by the offset value and the signal is repositioned within the diagram area. To set the offset automatically, use [Autoset].

Use the offset to measure small AC voltages that are overlaid by higher DC voltages. Unlike AC coupling, the DC part of the signal is not lost with offset setting.

Remote command:

[CHANnel<m>:OFFSet](#) on page 293

Position

Moves the selected signal up or down in the diagram. While the offset sets a voltage, position is a graphical setting given in divisions. The visual effect is the same as for offset.

Remote command:

[CHANnel<m>:POSition](#) on page 293

Ground

Connects the input to a virtual ground. All channel data is set to 0 V. Ground connection is labeled with **⏏**. The coupling is not affected by the ground setting.

Remote command:

[CHANnel<m>:COUPling](#) on page 293

Invert

Turns the inversion of the signal amplitude on or off. To invert means to reflect the voltage values of all signal components against the ground level. Inversion affects only the display of the signal but not the trigger.

For example: if the oscilloscope triggers on the rising edge, the trigger is not changed by inversion, but the actually rising edge is displayed as falling edge.

Inversion is indicated in the waveform labels by line above the channel name.

Remote command:

[CHANnel<m>:POLarity](#) on page 294

Deskew

Sets a time delay for the selected channel.

Deskew compensates delay differences between channels caused by the different length of cables, probes, and other sources. Correct deskew values are important for accurate triggering. Signals that are routed over lines with different lengths have a different propagation delay. This delay can lead to a non-synchronous waveform display. For example, a coax cable with a length of 1 meter has a propagation delay of typically 5.3 ns.

Remote command:

[CHANnel<m>:SKEW](#) on page 295

Zero Adjust

Differences in DUT and oscilloscope ground levels can cause larger zero errors, which affect the waveform. If the DUT is ground-referenced, the "Zero Adjust" corrects the zero error and sets the probe to the zero level.

You can assess the zero error by measuring the mean value of a signal that returns zero.

Remote command:

`CHANnel<m>:ZOFFset[:VALue]` on page 295

Waveform Color

Selects the color scale for the waveform color. Each scale comprises a set of colors, where each color represents a certain frequency of occurrence.

- | | |
|---------------|--------------------------------------------------------------------------------------------------------------------------|
| "Temperature" | Display in temperature colors. Blue corresponds to rare occurrences of the samples, while white indicates frequent ones. |
| "Rainbow" | Display in rainbow colors. Blue corresponds to rare occurrences of the samples, while red indicates frequent ones. |
| "Fire" | Display in fire colors. Yellow corresponds to rare occurrences of the samples, while red indicates frequent ones. |
| "Default" | Displays the waveform in its default monochrome color. |

Remote command:

`CHANnel<m>:WCOLor` on page 295

Probe

See [Chapter 4.3.4, "Probe Settings"](#), on page 45.

Threshold

See [Chapter 4.3.5, "Threshold Settings"](#), on page 46.

Label

See [Chapter 4.3.6, "Label Settings"](#), on page 47.

4.3.4 Probe Settings

For passive probes, which are connected with a BNC connector, you set the probe attenuation and the unit, and you can start an adjustment procedure for the probe. All settings are channel-specific. When you set the attenuation, you can select a predefined factor, for example "10:1", or enter a user-defined value.

Access: [Ch <n>] > "Probe" (scroll down). Or: short menu > "Probe"

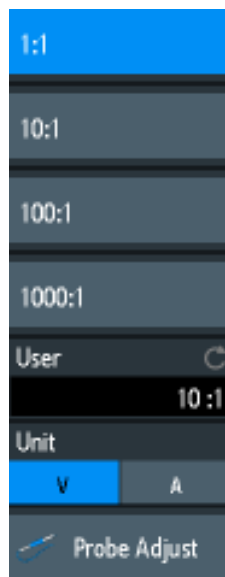

User

If default values do not fit, you can enter an arbitrary attenuation factor in the range between 0.001:1 and 1000:1. The vertical scaling and measured values are multiplied by this factor so that the displayed values are equal to the undivided measured signal values.

Remote command:

[PROBe<m>:SETup:ATTenuation:MANual](#) on page 298

[PROBe<m>:SETup:GAIN:MANual](#) on page 299

Unit

Selects the unit that the probe can measure.

- V - for voltage measurements
- A - for current measurements

Remote command:

[PROBe<m>:SETup:ATTenuation:UNIT](#) on page 298

[PROBe<m>:SETup:GAIN:UNIT](#) on page 298

Probe Adjust

Starts the probe adjustment procedure. A wizard explains the adjustment step by step.

4.3.5 Threshold Settings

A threshold is used for digitization of analog signals. If the signal value is higher than the threshold, the signal state is high (1 or true for the Boolean logic). Otherwise, the signal state is considered low (0 or false) if the signal value is below the threshold.

Access: [Ch <n>] > "Threshold" (scroll down).

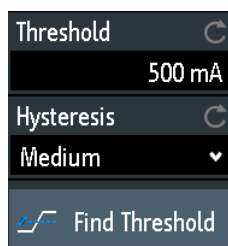

Threshold

A threshold is used for digitization of analog signals. If the signal value is higher than the threshold, the signal state is high (1 or true for the Boolean logic). Otherwise, the signal state is considered low (0 or false) if the signal value is below the threshold.

Remote command:

[CHANnel<m>:THReshold](#) on page 296

Hysteresis

To avoid the change of signal states due to noise, set the hysteresis. If the signal oscillates inside the hysteresis range and crosses the threshold, no state transition occurs.

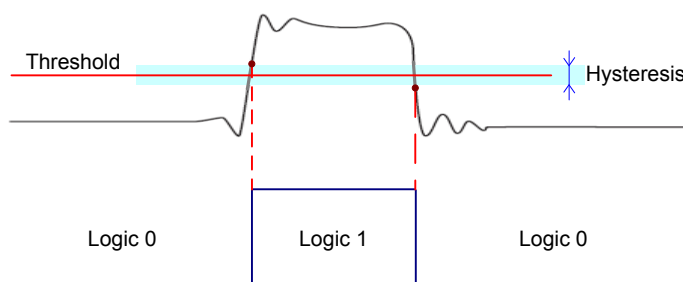

The numerical values of "Small", "Medium", and "Large" hysteresis correspond to the vertical scale.

Remote command:

[CHANnel<m>:THReshold:HYSTeresis](#) on page 297

Find Threshold

The instrument analyzes the channel and sets the threshold for digitization. If no level can be found, the existing value remains unchanged, and you can set the thresholds manually.

Remote command:

[CHANnel<m>:THReshold:FINDlevel](#) on page 297

4.3.6 Label Settings

In the "Label" menu, you can define a name label for the selected waveform.

Access: [Ch <n>] > "Label" (scroll down).

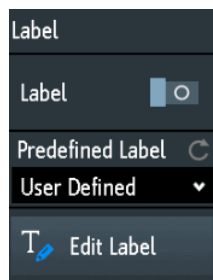

Label

Activates or deactivates the label display. The label is shown at the waveform on the right edge of the display.

Remote command:

[CHANnel<m>:LAbel:STATe](#) on page 297

[CHANnel<m>:LAbel](#) on page 297

Predefined Label

Selects a predefined label text. You can edit the text with "Edit Label".

Edit Label

Opens on-screen keypad to enter a label text. If you previously have selected a predefined label, it is already written in the entry line, and you can modify it.

The maximum name length is 8 characters, and only ASCII characters provided on the on-screen keypad can be used.

4.4 Horizontal Setup

Horizontal settings, also known as timebase settings, adjust the waveforms in horizontal direction.

Typically, the trigger is the determining point of the waveform record. In many scenarios, you want to analyze the waveform some time before or after the trigger. To adjust the horizontal acquisition window to the waveform section of interest, you can use the following parameters:

- The **horizontal position** defines the time distance of the trigger point (the zero point of the diagram) to the reference point. Changing the horizontal position, you can move the trigger point, even outside the screen.
- The **reference point** is the rescaling center of the time scale on the screen. If you modify the time scale, the reference point remains fixed on the screen, and the scale is stretched or compressed to both sides of the reference point.

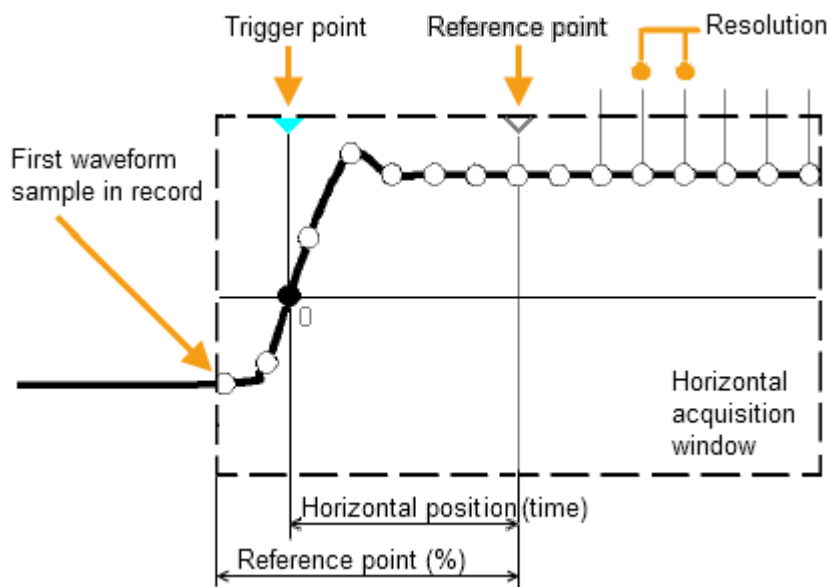

Unlike vertical settings, which are waveform-specific, the horizontal settings apply to all active waveforms.

There are several ways to adjust horizontal settings:

- Use the controls in the Horizontal functional block of the front panel to scale the waveforms, and to set the position.
- Drag one finger horizontally on the screen to change the horizontal position. Spread or pinch two fingers to change the horizontal scale.
- Use shortcuts to adjust scale and position.
- Use the comprehensive menu to adjust all horizontal settings.

4.4.1 HORIZONTAL Controls



[Position]

Changes the trigger position, the time distance from the trigger point to the reference point (trigger offset). The trigger point is the zero point of the diagram. Thus, you can set the trigger point even outside the diagram and analyze the signal some time before or after the trigger.

Turn clockwise to move the position to the right, and press the knob to reset the value to zero. The current value is shown in the information bar.

In zoom and FFT, the knob sets the position in the active diagram. Tap the diagram that you want to adjust. If a zoom is active, either the position of the zoom window or the trigger position is changed. In an FFT diagram, the knob changes the center frequency in frequency domain, or the trigger position in time domain.

Remote command:

[TIMEbase:POSition](#) on page 299

[REFCurve<m>:HORizontal:POSition](#) on page 323

[TIMEbase:ZOOM:TIME](#) on page 317

[Scale]

Adjusts the time scale of the horizontal axis for all signals, also known as timebase.

Turn clockwise to stretch the waveforms - the scale value time/div decreases. Press the knob to toggle between coarse and fine scale adjustment. The current value is shown in the information bar.

In a zoom diagram, the knob changes the zoom scale. In an FFT diagram, the knob changes the span. Tap the diagram that you want to adjust.

Remote command:

[TIMEbase:SCALE](#) on page 299

[REFCurve<m>:HORizontal:SCALE](#) on page 323

[TIMEbase:ZOOM:SCALE](#) on page 317

[Zoom]

Enables or disables the zoom with the last configuration.

See also: [Chapter 6.1, "Zoom"](#), on page 74.

Remote command:

[TIMEbase:ZOOM:STATE](#) on page 317

[Horizontal]

Opens the menu to configure horizontal scale, position, and reference point. The current scale and position is shown in the top information bar.

If zoom is active, you can find also the zoom scale and zoom position in this menu.

[Acquisition]

Opens the "Acquisition" menu. Here you control the data processing - how the waveform is built from the captured samples. The current acquisition mode is shown in the top information bar.

See also: [Chapter 4.5, "Acquisition Setup"](#), on page 52.

4.4.2 Shortcuts for Horizontal Settings

To adjust the horizontal scale and the position, you can use the shortcuts on the top of the display. The labels show the current values.

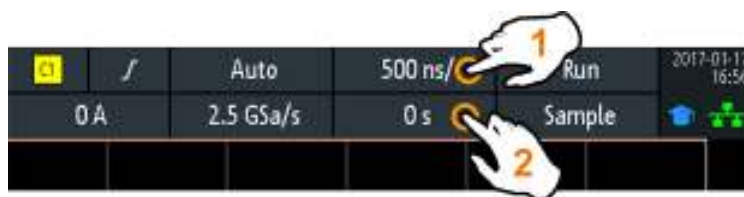

- 1 = adjust horizontal scale
2 = adjust horizontal position

4.4.3 Horizontal Settings

The comprehensive "Horizontal" menu contains all horizontal settings. In zoom mode, also zoom settings are listed in the menu.

- To open the menu, press the [Horizontal] key.

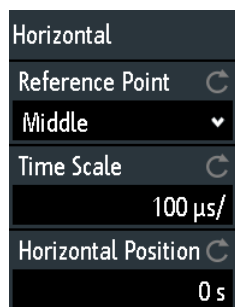

Reference Point

Defines the time reference point in the diagram. It is indicated by a gray triangle outline at the bottom of the diagram.

The reference point defines which part of the waveform is shown. By default, the reference point is displayed in the center of the window, and you can move it to the left or right.

The reference point is the rescaling center of the time scale on the screen. If you modify the time scale using the [Scale] knob, the reference point remains fixed on the screen, and the scale is stretched or compressed to both sides of the reference point. If you spread and pinch two fingers on the touchscreen to change the time scale, then the reference point is set between the fingers.

Remote command:

[TIMebase:REFerence](#) on page 300

Time Scale

Defines the time scale of the horizontal axis for all signals, also known as timebase. The scaling is indicated in the information bar above the grid.

Remote command:

[TIMebase:SCALE](#) on page 299

Horizontal Position

Defines the trigger position, the time distance from the trigger point to the reference point (trigger offset). The trigger point is the zero point of the diagram. Changing the horizontal position, you can move the trigger, even outside the screen.

If you want to see a section of the waveform some time before or after the trigger, enter this time as horizontal position. The requested waveform section is shown around the reference point. Use positive values to see waveform sections after the trigger - the waveform and the diagram origin move to the left.

The value is indicated in the information bar above the grid.

Remote command:

[TIMEbase:POSition](#) on page 299

4.5 Acquisition Setup

During an acquisition, the R&S RTB2000 captures the signal and converts it to digital samples. The digital samples are processed according to the acquisition settings. The result is a waveform record that is displayed on the screen and stored in memory.

The number of waveform samples in one waveform record is called the record length. The rate of recording waveform samples - the number of waveform samples per second - is the sample rate. The higher the sample rate, the better is the resolution and the more details of the waveform are visible.

A sufficient resolution is essential for correct reconstruction of the waveform. If the signal is undersampled, aliasing occurs - a false waveform is displayed. To avoid aliasing and accurately reconstruct a signal, the sample rate must be at least 3 to 5 times the fastest frequency component of the signal.

There are several ways to adjust and control acquisition:

- Use the controls in the Trigger functional block of the front panel to start and stop acquisition. See [Chapter 5.1, "Trigger Controls"](#), on page 58.
 - Use shortcuts to adjust the acquisition mode, and to perform a single acquisition.
 - Use the comprehensive menu to adjust all acquisition settings.
- To start or stop acquisition, use the [Run Stop] and [Single] keys in the Trigger section at the front panel.

4.5.1 Shortcuts for Acquisition Settings

To adjust the acquisition mode, and to perform a single acquisition, you can use the shortcuts on the top of the display. The labels show the current values.

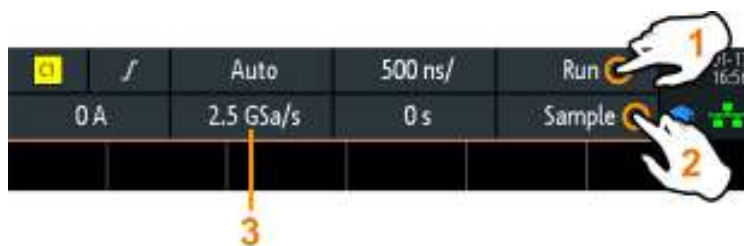

- 1 = start or stop a continuous acquisition, or start a single acquisition if [Single] is active
- 2 = adjust the acquisition mode
- 3 = shows the current sample rate for information

4.5.2 Acquisition Settings

Acquisition settings define the processing of the captured samples in the instrument. The current acquisition mode and sample rate are shown in the top information bar.

- To adjust acquisition settings, press the [Acquisition] key.

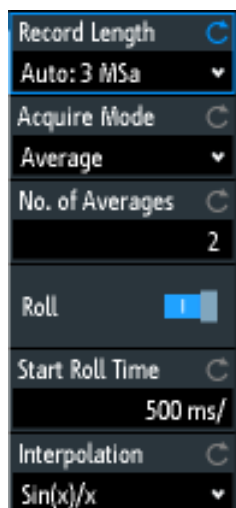

The history is described in [Chapter 6.4.3, "History Settings"](#), on page 89.

Record Length

Sets the record length, the number of waveform samples that are stored in one waveform record.

If you use the history, you can disable the "Auto" record length and enter a value in the "History" menu. In this case, the defined record length is shown in the "Acquisition" menu.

Remote command:

[ACQUIRE:POINTS:AUTOMATIC](#) on page 301

[ACQUIRE:POINTS\[:VALUE\]](#) on page 301

Acquire Mode

Defines how the waveform is built from the captured samples. There are two general methods to build the waveform record: sample decimation and waveform arithmetic.

Sample decimation reduces the data stream of the ADC to a stream of waveform points with lower sample rate and a less precise time resolution. The R&S RTB2000 uses decimation, if the waveform sample rate is less than the ADC sample rate. The acquisition modes "Peak Detect" and "High Resolution" are decimation methods.

Waveform arithmetic builds the resulting waveform from several consecutive acquisitions of the signal. The acquisition modes "Average" and "Envelope" are arithmetic methods.

"Sample"	<p>Usually, most signals are displayed optimally with this acquisition mode but very short glitches might remain undiscovered by this method.</p> <p>If the sample rate of the waveform is less than the ADC sample rate, the instrument reduces the number of samples: one of n samples in a sample interval is recorded as waveform point, the other samples are discarded (decimation). Conversely, if the sample rate of the waveform is higher than the ADC sample rate, the instrument adds waveform points to the captured samples using an interpolation method.</p>
"Peak Detect"	<p>The minimum and the maximum of n samples are recorded as waveform points, the other samples are discarded. Thus the instrument can detect fast signal peaks at slow time scale settings that would be missed with other acquisition modes.</p>
"High Resolution"	<p>The average of n captured sample points is recorded as one waveform sample. Averaging reduces the noise, the result is a more precise waveform with higher vertical resolution.</p>
"Average"	<p>The average is calculated from the data of the current acquisition and a number of consecutive acquisitions before. The method reduces random noise. It requires a stable, triggered and repetitive signal. The number of acquisitions for average calculation is defined with "No. of Averages" on page 55.</p> <p>If the waveform is clipped, the instrument shows a distorted average waveform to indicate the clipping. Adjust the vertical scale to avoid the clipping.</p>
"Envelope"	<p>Each acquisition is done in sample mode, and the minimum and maximum values over some consecutive acquisitions build the envelope. The resulting diagram shows two envelope waveforms below and above the normal waveform: the minimums (floor) and maximums (roof), representing the borders in which the signal occurs. this method is useful, for example, if the waveform is noisy but the noise is not relevant for the measurement.</p>
"Envelope + PD"	<p>Each acquisition is done in peak detect mode, and the most extreme values of all consecutive acquisitions build the envelope. This method is more precise than "Envelope".</p>

Remote command:

[ACquire:TYPE](#) on page 302

[CHANnel<m>:ARITHmetics](#) on page 303

[CHANnel<m>:TYPE](#) on page 302

[ACQUIRE:PEAKdetect](#) on page 303

[ACQUIRE:HRESolution](#) on page 303

No. of Averages

Defines the number of waveforms used to calculate the average waveform. The higher the number, the better the noise is reduced.

To restart the average calculation, press the [Clear Screen] key.

Remote command:

[ACQUIRE:AVERage:COUNT](#) on page 304

[ACQUIRE:AVERage:RESet](#) on page 304

Nx Single

Sets the number of waveforms that are acquired with a [Single] acquisition.

The setting is available if the history option is installed.

Remote command:

[ACQUIRE:NSINgle:COUNT](#) on page 290

Roll

Enables the automatic roll mode. The instrument switches to roll mode if the [Time Scale](#) is equal or slower than [Start Roll Time](#).

The roll mode displays the untriggered, continuous signal, and moves the captured input data on the display from the left to the right. The instrument shows the waveform immediately, without waiting for the complete acquisition of the waveform record. The record length is set automatically ("Auto" mode). Some math functions are non-calculable if roll mode is active.

You can use the horizontal and vertical zoom in roll mode if the acquisition is stopped.

Remote command:

[TIMEbase:ROLL:AUTomatic](#) on page 304

Start Roll Time

Sets the limit timebase for the roll mode. The instrument switches automatically to roll mode if:

- the [Time Scale](#) exceeds the value given here.
- the roll mode is activated ([Roll](#)).

Remote command:

[TIMEbase:ROLL:MTIME](#) on page 305

Interpolation

Selects the interpolation method if interpolation is required to get the defined record length.

"Sin(x)/x"

Two adjacent ADC sample points are connected by a $\sin(x)/x$ curve, and also the adjoining sample points are considered by this curve. The interpolated points are placed on the resulting curve. This interpolation method is the default method. It is precise and shows the best signal curve.

- "Linear" Two adjacent ADC sample points are connected by a straight line, the interpolated points are placed on the line. You see a polygonal waveform similar to the real signal, and also the ADC sample points as vertexes.
- "Sample-Hold" The ADC sample points are displayed like a histogram. For each sample interval, the voltage is taken from the sample point and considered as constant, and the intervals are connected with vertical lines. Thus, you see the discrete values of the ADC.

Remote command:

[ACquire:INTerpolate](#) on page 305

5 Trigger

Triggering means to capture the interesting part of the relevant waveforms. Choosing the right trigger type and configuring all trigger settings correctly allows you to detect various incidents in signals.

A trigger occurs if the trigger conditions are fulfilled. The instrument acquires continuously and keeps the sample points to fill the pretrigger part of the waveform record. When the trigger occurs, the instrument continues acquisition until the posttrigger part of the waveform record is filled. Then it stops acquiring and displays the waveform. When a trigger is recognized, the instrument does not accept another trigger until the acquisition is complete.

Trigger conditions include:

- Source of the trigger signal (channel)
- Trigger type and its setup
- Trigger mode

In addition, the horizontal position of the trigger point and the reference point are important to display the interesting part of the signal. See [Chapter 4.4, "Horizontal Setup"](#), on page 48.

The trigger level and position are marked in the grid. The markers have the color of the trigger source. Information on the most important trigger settings is shown in the upper information bar.

There are several ways to set up the trigger:

- Use the controls in the Trigger functional block of the front panel.
- Use shortcuts to adjust the trigger source, trigger mode, and main parameters of the trigger type.
- Use the comprehensive menu to select the trigger type and to adjust all trigger settings.

The R&S RTB2000 can output a pulse at the Aux Out connector when the instrument triggers. See

• Trigger Controls	58
• Shortcuts for Trigger Settings	59
• General Trigger Settings	60
• Edge Trigger	62
• Width Trigger	64
• Video Trigger	67
• Pattern Trigger	69
• Timeout Trigger	71
• Trigger Out Signal	73

5.1 Trigger Controls

The keys and the rotary knob in the Trigger functional block adjust the trigger and start or stop acquisition.

The green LED above the [Levels] knob lights up when the instrument triggers.



[Trigger]

Opens the "Trigger" menu.

[Source]

Changes the analog trigger source. Press the key repeatedly until the required analog source is selected. If a digital source or serial bus was selected in the "Trigger" menu, or if the "Trigger Type" is set to "Pattern", the key opens the menu.

The key lights up in the color of the selected channel, and the selected source is shown in the information bar.

Remote command:

[TRIGger:A:SOURce](#) on page 307

[Auto Norm]

Toggles the trigger mode between "Auto" and "Norm". The key lights up in white if the trigger mode is "Norm". The current mode is also shown in the information bar.

"Auto" The instrument triggers repeatedly after a time interval if the trigger conditions are not fulfilled. If a real trigger occurs, it takes precedence. This mode helps to see the waveform even before the trigger is set. The waveform on the screen is not synchronized, and successive waveforms are not triggered at the same point of the waveform.

"Norm" The instrument acquires a waveform only if a trigger occurs, that is, if all trigger conditions are fulfilled. If no trigger occurs, no waveform is acquired and the last acquired waveform is displayed. If no waveform was captured before, nothing is displayed.

Remote command:

[TRIGger:A:MODE](#) on page 307

[Levels]

The rotary knob changes the trigger level. Turn clockwise to move up the trigger level.

Pressing the knob sets the level to 50% of the signal amplitude.

Remote command:

[TRIGger:A:LEVel<n>\[:VALue\]](#) on page 309

[TRIGger:A:FINDlevel](#) on page 309

[Force Trigger]

Provokes an immediate single acquisition. Use this key if the acquisition is running in normal mode and no valid trigger occurs. Thus, you can confirm that a signal is available and use the waveform display to determine how to trigger on it.

Remote command:

[*TRG](#) on page 289

[Run Stop]

Starts and stops the continuous acquisition. A green light indicates a running acquisition. A red light shows that acquisition is stopped.

The status is shown also at the right end of the information bar: "Run", "Complete", "Trig?" (waiting for trigger, in normal trigger mode) or "Not ready" (working). For slow timebases, the status "Pre" or "Post" is shown together with an indicator that shows the filling level of the buffer.

Remote command:

[RUN](#) on page 290

[RUNContinuous](#) on page 290

[STOP](#) on page 291

[ACquire:STATe](#) on page 291

[Single]

Starts a specified number of acquisitions. A white light indicates that the instrument is in single mode. The information bar shows "Complete" if the acquisition has been finished.

If the history option R&S RTB2000-K15 is available, you can set the number of acquisitions: press the [Acquisition] key and enter "Nx Single".

Remote command:

[SINGLE](#) on page 290

[RUNSingle](#) on page 290

5.2 Shortcuts for Trigger Settings

To adjust the trigger source, mode, and trigger type specific settings, you can use the shortcuts on the top of the display. The labels show the current values.

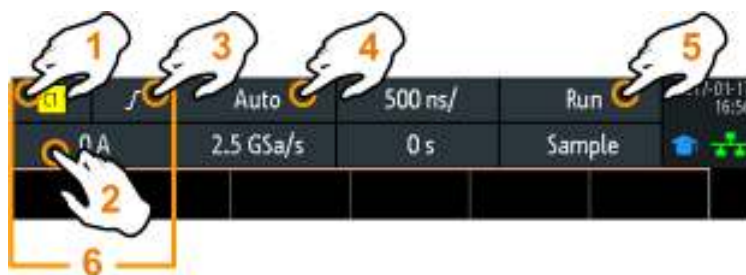

- 1 = adjust the trigger source
- 2 = open the keypad to enter the value of the trigger level or threshold
- 3 = adjust slope or polarity
- 4 = adjust the trigger mode
- 5 = start or stop a continuous acquisition, or start a single acquisition if [Single] is active
- 6 = available settings depend on the trigger type

5.3 General Trigger Settings

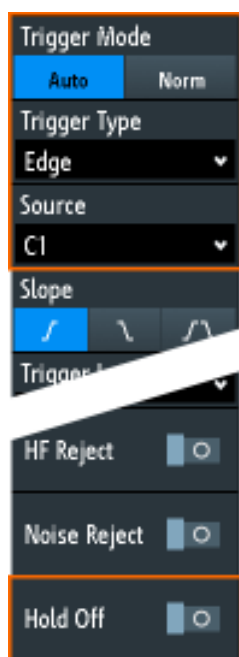

General trigger settings are independent of the trigger type. They are highlighted in the above figure and described in the current section. The other trigger settings are specific for individual trigger types, and they are described in the following sections.

Trigger Mode

Toggles the trigger mode between "Auto" and "Norm". The trigger mode determines the behavior of the instrument if no trigger occurs. The current setting is shown in the information bar.

- "Auto" The instrument triggers repeatedly after a time interval if the trigger conditions are not fulfilled. If a real trigger occurs, it takes precedence. This mode helps to see the waveform even before the trigger is set. The waveform on the screen is not synchronized, and successive waveforms are not triggered at the same point of the waveform.
- "Norm" The instrument acquires a normal waveform only, if a trigger occurs, that is, if all trigger conditions are fulfilled. If no trigger occurs, no waveform is acquired and the last acquired waveform is displayed. If no waveform was captured before, nothing is displayed.

Remote command:

[TRIGger:A:MODE](#) on page 307

Trigger Type

Selects the trigger type.

- "Edge" Triggers on signal edges.
See [Chapter 5.4, "Edge Trigger"](#), on page 62.
- "Width" Triggers on pulse width.
See [Chapter 5.5, "Width Trigger"](#), on page 64.
- "Video" Triggers on various PAL, NTSC and HDTV standard video signals.
See [Chapter 5.6, "Video Trigger"](#), on page 67.
- "Pattern" Triggers on logical combinations of the input channels.
See [Chapter 5.7, "Pattern Trigger"](#), on page 69.
- "Timeout" Triggers on signal level timeout.
See [Chapter 5.8, "Timeout Trigger"](#), on page 71.
- "Line" The line trigger uses the waveform of the power supply's alternating line voltage (typically 50 Hz or 60 Hz AC) as the trigger signal source. Use this trigger to detect issues related to the frequency of the power grid.
The line trigger does not have any settings.
- "Serial Bus" Triggers on a serial bus. Requires that at least one protocol option R&S RTB-K1, -K2, or -K3 is installed, a serial bus is configured, and a decoded signal is available.
See [Chapter 12.1.1, "Protocol - Common Settings"](#), on page 189.

Remote command:

[TRIGger:A:TYPE](#) on page 307

Source

Selects the trigger source.

- "C1, C2, C3, C4" Select one of the analog input channels as trigger source.
- "D0 to D15" Select one of the digital channels as trigger source if MSO option R&S RTB-B1 is installed.
Not available for video trigger.
- "Extern" Sets the external trigger input on the front panel as trigger source.
Available for edge and video trigger.

"B1 or B2" Serial bus that is used for triggering on protocols. Only available, if the trigger type "Serial Bus" is selected.

Remote command:

[TRIGger:A:SOURce](#) on page 307

Hold Off, Hold Off Time

Enables the hold off and defines the "Hold Off Time". The next trigger occurs only after the hold off time has passed.

The trigger "Hold Off" defines when the next trigger event is recognized after the current trigger event. Thus, it affects the next trigger to occur after the current one. Hold off helps to obtain stable triggering when the oscilloscope is triggering on undesired events.

Remote command:

[TRIGger:A:HOLDoff:MODE](#) on page 308

[TRIGger:A:HOLDoff:TIME](#) on page 308

5.4 Edge Trigger

The edge trigger is the most common trigger type. The trigger occurs when the signal from the trigger source passes the trigger level in the specified direction (slope).

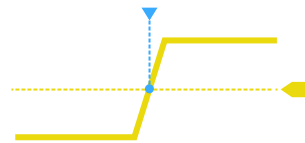
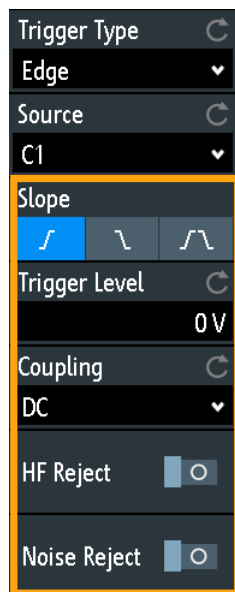

Figure 5-1: Edge trigger event with positive slope (rising edge)



► [Trigger] > "Trigger Type" = "Edge"



Slope.....	63
Trigger Level, Threshold.....	63
Coupling.....	63
HF Reject.....	64
Noise Reject.....	64

Slope

Sets the edge direction for the trigger. You can trigger on:

-  rising edge, that is a positive voltage change
-  falling edge, that is a negative voltage change
-  rising and falling edge. After starting an acquisition, the instrument triggers on the first identified edge.

Remote command:

`TRIGger:A:EDGE:SLOPe` on page 308

Trigger Level, Threshold

Sets the voltage level or threshold for the trigger.

You can also drag the trigger level marker on the display, or turn the Levels knob. To set the trigger level to 50% of the signal amplitude, press the Levels knob.

For width and timeout trigger, the trigger level is the threshold of the trigger source.

Remote command:

`TRIGger:A:LEVel<n>[:VALue]` on page 309

`TRIGger:A:FINDlevel` on page 309

Coupling

Sets the coupling for the trigger source.

"AC" Alternating current coupling. A highpass filter removes the DC offset voltage from the trigger signal.

"DC" Direct current coupling. The trigger signal remains unchanged.

"LF Reject" Sets the trigger coupling to high frequency. A 15 kHz highpass filter removes lower frequencies from the trigger signal. Use this mode only with very high frequency signals.

Remote command:

[TRIGger:A:EDGE:COUPling](#) on page 309

HF Reject

Enables or disables an additional 5 kHz lowpass filter in the trigger path. This filter removes higher frequencies and is available with AC and DC coupling.

You can use either "HF Reject" or "Noise Reject".

Remote command:

[TRIGger:A:EDGE:FILTer:HFReject](#) on page 310

Noise Reject

Extends the hysteresis to avoid unwanted trigger events caused by noise oscillation around the trigger level.

You can use either "HF Reject" or "Noise Reject".

Remote command:

[TRIGger:A:EDGE:FILTer:NREJect](#) on page 310

5.5 Width Trigger

The width trigger compares the pulse width (duration) with given time limits. It detects pulses with an exact pulse width, pulses shorter or longer than a given time, and also pulses inside or outside the allowable time range. The pulse width is measured at the trigger level.

You can use the width trigger, for example, to trigger on glitches.

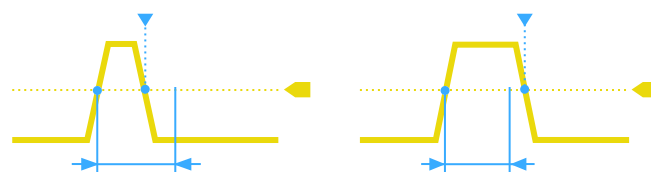

Figure 5-2: Pulse width is shorter (left) or longer (right) than a given duration (also known as glitch trigger)

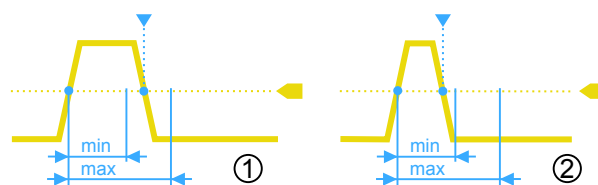

Figure 5-3: Pulse width is inside or outside an allowable time range

1 = Inside: $\text{min width} < \text{pulse} < \text{max width}$

2 = Outside: $\text{pulse} < \text{min width}$ OR $\text{pulse} > \text{max width}$

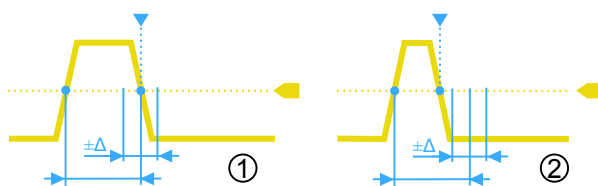

Figure 5-4: Pulse width is equal or unequal to a given duration, with optional variation (Δ)

- 1 = Equal: (width - variation) < pulse < (width + variation)
- 2 = Unequal: pulse < (width - variation) OR pulse > (width + variation)

► [Trigger] > "Trigger Type" = "Width"



Polarity.....	65
Comparison.....	66
Time t.....	66
Variation.....	66
Time t1, Time t2.....	66
Threshold.....	66
Hysteresis.....	66

Polarity

Sets the polarity of the pulse. You can trigger on:

- positive going pulse, the width is defined from the rising to the falling slopes.
- negative going pulse, the width is defined from the falling to the rising slopes.

Remote command:

TRIGger:A:WIDTh:POLarity on page 311

Comparison

Sets how the measured pulse width is compared with the given limits.

"Width >"	Triggers on pulse width longer than the reference "Time t".
"Width <"	Triggers on pulse width shorter than the reference "Time t".
"Width ="	Triggers on pulse width equal to the reference "Time t" if "Variation" $\Delta t = 0$. If "Variation" $\neq 0$, this setting triggers on pulses within the range $t \pm \Delta t$.
"Width \neq "	Triggers on pulses unequal to the reference "Time t", if "Variation" $\Delta t = 0$. If "Variation" $\neq 0$, this setting triggers on pulses outside a range $t \pm \Delta t$.
"Inside"[,]"Out-side"	Triggers on pulses inside or outside a range specified with "Time t1" and "Time t2". This method is an alternative setting to the range definition with "Time t" and "Variation". The values are interdependent. "Variation" and "Time t" are adjusted, if you change t1 and t2, and vice versa.

Remote command:

[TRIGger:A:WIDTH:RANGe](#) on page 311

Time t

Sets the reference time, the nominal value for comparison settings "Width >", "Width <", "Width =", and "Width \neq ".

Remote command:

[TRIGger:A:WIDTH:WIDTH](#) on page 311

Variation

Sets a range Δt to the reference "Time t", if comparison is set to "Width =" or "Width \neq ". The instrument triggers on pulses inside or outside the range $t \pm \Delta t$.

Remote command:

[TRIGger:A:WIDTH:DELTA](#) on page 312

Time t1, Time t2

Set the lower and upper time limits defining the time range if "Width =" or "Width \neq " is set for comparison. "Time t" and "Variation" are adjusted accordingly.

Remote command:

[TRIGger:A:WIDTH:RANGe](#) on page 311

[TRIGger:A:WIDTH:DELTA](#) on page 312

Threshold

Threshold of the trigger source channel, used as trigger level for the width trigger.

See also "[Threshold](#)" on page 47 and "[Trigger Level, Threshold](#)" on page 63.

Remote command:

[TRIGger:A:LEVel<n>\[:VALue\]](#) on page 309

[CHANnel<m>:THReshold](#) on page 296

Hysteresis

Hysteresis of the trigger source channel, see "[Hysteresis](#)" on page 47.

Remote command:

CHANnel<m>:THReshold:HYSteresis on page 297

5.6 Video Trigger

The video or TV trigger is used to analyze analog baseband video signals. You can trigger on baseband video signals from standard definition and high definition standards connected to an analog channel input or to the external trigger input.

The instrument triggers on the sync pulses.

First select the standard and the signal polarity, then decide to trigger on lines or fields and enter the specific settings.

► [Trigger] > "Trigger Type" = "Video"

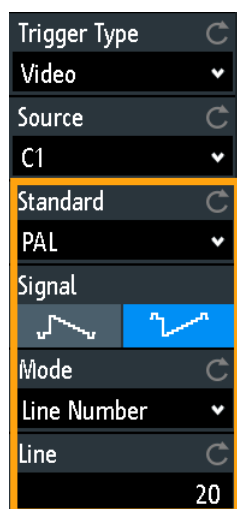

Figure 5-5: Video trigger menu

Standard.....	67
Signal.....	68
Mode.....	68
Line.....	68

Standard

Selects the color television standard.

You can trigger on various standard-definition television (SDTV) signals:

- "PAL"
- "NTSC"
- "SECAM"
- "PAL-M"
- "SDTV 576i" (PAL and SECAM)

High-definition television (HDTV) standards are indicated by the number of active lines and the scanning system:

- "HDTV 720p"
- "HDTV 1080p" (p for progressive scanning)
- "HDTV 1080i" (i for interlaced scanning)

Remote command:

[TRIGger:A:TV:STANdard](#) on page 312

Signal

Selects the polarity of the signal. Note that the sync pulse has the opposite polarity. If the video modulation is positive, the sync pulses are negative. If the modulation is negative, sync pulses are positive. The edges of the sync pulses are used for triggering, therefore incorrect polarity setting causes a sporadic triggering by the video information.

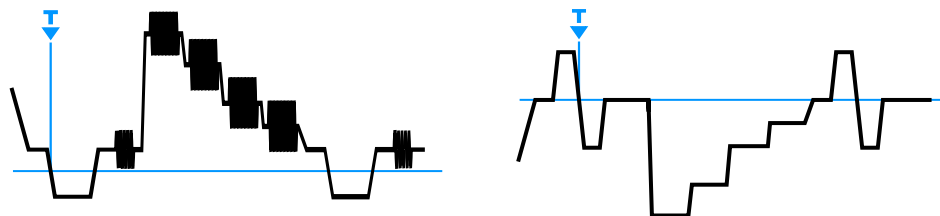

Figure 5-6: Positive video signal with negative bi-level sync pulse (SDTV, left) and negative signal with positive tri-level sync pulse (HDTV, right)

Remote command:

[TRIGger:A:TV:POLarity](#) on page 312

Mode

Selects from the following the trigger conditions:

- "All Frames" The oscilloscope triggers on the beginning of all video signal frames.
- "Odd Frames" The oscilloscope triggers on the beginning of video signal frames with an odd frame number.
- "Even Frames" The oscilloscope triggers on the beginning of video signal frames with an even frame number.
- "All Lines" The oscilloscope triggers on the beginning of all video signal lines.
- "Line Number" Triggers on an exact "Line" number.

Remote command:

[TRIGger:A:TV:FIELD](#) on page 313

Line

Sets an exact line number if "Mode" is "Line Number". The oscilloscope triggers exactly on the beginning of the selected line in any field.

Remote command:

[TRIGger:A:TV:LINE](#) on page 313

5.7 Pattern Trigger

The pattern trigger is a logic trigger. It provides any logical combination of the input channels and supports you in verifying the operation of digital logic. Additionally, you can set a time limitation to the pattern. Thus you can also trigger on bus patterns of parallel buses.

The channel pattern is configured in the "Logic Editor" dialog box.

- ▶ [Trigger] > "Trigger Type" = "Pattern" > "Edit Pattern"

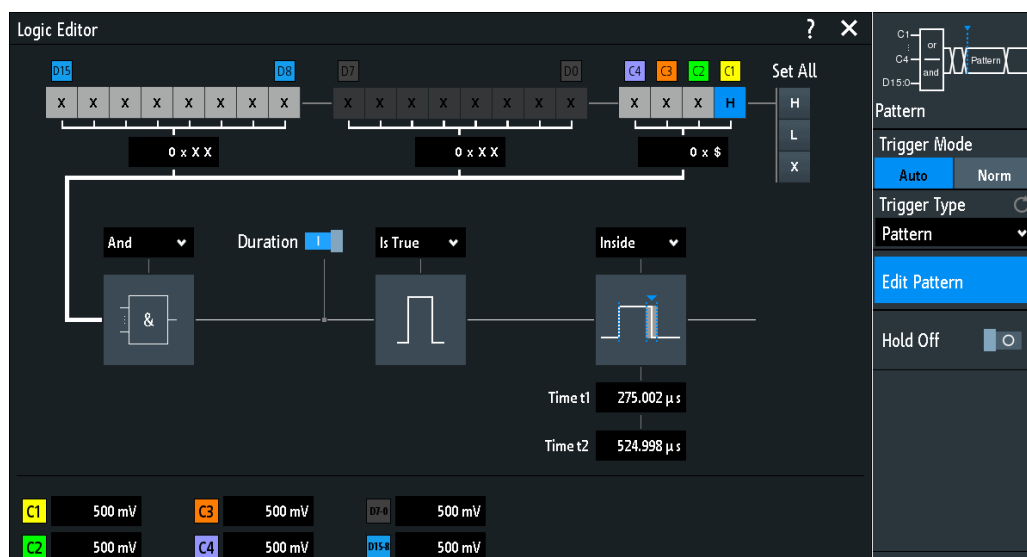

Figure 5-7: Pattern trigger with logic editor

Thresholds

At the bottom of the "Logic Editor", you see the current threshold settings of all channels. Here, you can directly activate the channels, and change the threshold values.

The thresholds of analog channels are also set in the "Channel <n>" > "Threshold" menu, see also [Chapter 4.3.5, "Threshold Settings"](#), on page 46.

The thresholds of logic channels are set in the "Logic" menu, see [Chapter 13.2, "Logic Analyzer Settings"](#), on page 252.

Logic settings

H L X, Set All.....	70
And Or.....	70
Duration.....	70
True False.....	70
Time limitation.....	70

H | L | X, Set All

Defines the pattern by selecting the state "H" (high), "L" (low) or "X" (do not care) for each active analog and digital channel.

The word length of the pattern depends on the number of available analog and digital channels.

Analog channels: 2 bit for 2-channel instruments, 4 bit for 4-channel instruments.

Digital (16 bit): the logic channels D0, D1,...,D15 are only available with MSO option R&S RTB-B1.

Thus the pattern can have 2, 4, 18, or 20 bits.

Use "Set All" to set all channels to the same state.

Remote command:

[TRIGger:A:PATtern:SOURce](#) on page 313

And | Or

Sets the logical combination of the channel states.

"AND" All defined states must be true.

"OR" At least one of the defined states must be true.

Remote command:

[TRIGger:A:PATtern:FUNCTion](#) on page 314

Duration

The switch has the following two effects:

- Selects the mode of the [True | False](#) comparison.
- Enables or disables the [Time limitation](#).

True | False

Defines whether the instrument triggers on fulfillment of the logical condition, or on violation.

- If [Duration](#) = on, the instrument triggers when the logic combination "Is True" or "Is False" for a specified time duration.
- If [Duration](#) = off, the instrument triggers when the logic combination is found in the signal ("Goes True"), or if it disappears ("Goes False").

Remote command:

[TRIGger:A:PATtern:CONDition](#) on page 314

Time limitation

To set a time limitation for the pattern, you have several possibilities. They are similar to the setting of a pulse width, see [Chapter 5.5, "Width Trigger"](#), on page 64.

- "Timeout" and "Time t"
Define a minimum time during which the signals match the pattern condition.
- "Width >" or "Width <" and "Time t"
Triggers if the pattern condition changes before or after the specified time.
- "Width =", "Time t1" and "Variation"
Triggers if the pattern condition is fulfilled for a duration "Time t1" ± "Variation".
- "Width ≠", "Time t1" and "Variation"

Triggers if the pattern condition is fulfilled for a duration shorter than "Time t1" - "Variation", or longer than "Time t1" + "Variation".

- "Inside", "Time t1" and "Time t2"

Triggers if the pattern condition is fulfilled for a duration between "Time t1" and "Time t2". These settings are an alternative setting to the definition with "Width =". The time values are interdependent and adjusted accordingly.

- "Outside", "Time t1" and "Time t2"

Triggers if the pattern condition is fulfilled for a duration shorter than "Time t1", or longer than "Time t2". These settings are an alternative setting to the definition with "Width ≠". The time values are interdependent and adjusted accordingly.

Remote command:

[TRIGger:A:PATtern:MODE](#) on page 315

[TRIGger:A:PATtern:WIDTh:RANGe](#) on page 315

[TRIGger:A:PATtern:WIDTh\[:WIDTh\]](#) on page 315

[TRIGger:A:PATtern:WIDTh:DELTA](#) on page 316

5.8 Timeout Trigger

The timeout trigger checks if the signal stays above or below the threshold voltage for a specified time lapse. In other words, the trigger occurs if the trigger source signal does not cross the threshold during the specified time.

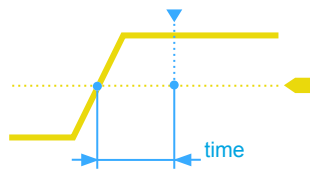

Figure 5-8: Timeout trigger with range Stays High

- ▶ [Trigger] > "Trigger Type" = "Timeout"



Figure 5-9: Timeout trigger menu

Range

Selects the relation of the signal level to the threshold:

Stays High The signal level stays above the trigger level.

Stays Low The signal level stays below the trigger level.

Stays High|Low The signal level stays above or below the trigger level.

Remote command:

[TRIGger:A:TIMEout:RANGe](#) on page 316

Time

Defines the time limit for the timeout at which the instrument triggers.

Remote command:

[TRIGger:A:TIMEout:TIME](#) on page 316

Threshold

Threshold of the trigger source channel, used as trigger level for the timeout trigger.

See also "[Threshold](#)" on page 47 and "[Trigger Level, Threshold](#)" on page 63.

Remote command:

[TRIGger:A:LEVel<n>\[:VALue\]](#) on page 309

[CHANnel<m>:THReshold](#) on page 296

Hysteresis

Hysteresis of the trigger source channel, see "[Hysteresis](#)" on page 47.

Remote command:

[CHANnel<m>:THReshold:HYSTeresis](#) on page 297

5.9 Trigger Out Signal

The R&S RTB2000 can output a pulse at the Aux Out connector when the instrument triggers.

1. To output a pulse at a trigger event, configure the Aux Out connector: "Setup" menu > "Aux Out" > "Trigger Out".
See also: "[Aux Out](#)" on page 167.
2. Using remote commands, you can set the pulse width and polarity of the trigger out pulse. The commands are described in [Chapter 15.10.5, "Trigger Out"](#), on page 432.

6 Waveform Analysis

• Zoom.....	74
• Mathematics.....	78
• Reference Waveforms.....	83
• History and Segmented Memory (Option R&S RTB-K15).....	87
• Search.....	96

6.1 Zoom

The zoom magnifies a part of the waveform to view more details. The zoom is applied to all active analog and digital channels and math waveforms.

The following zoom types are available:

- Horizontal zoom: the waveforms are displayed with a shorter time scale while the vertical scale remains unchanged.
- Vertical zoom: the zoom waveforms are enlarged in vertical and horizontal direction.

6.1.1 Zooming In

When you activate the zoom, two windows are displayed: the original waveform diagram at the top, and the zoom window at the bottom.

If zoom is active, the time scale of the original waveform diagram is at least 80 ns/div. When you activate the zoom at a smaller time scale, the instrument changes the time scale to the minimum value.

- ▶ To activate the horizontal zoom, press the [Zoom] key.
- ▶ To activate the vertical zoom:
 - a) Tap the "Zoom" icon on the toolbar.
 - b) Drag your finger on the screen to draw the diagonal of the zoom area. You can draw the zoom area on the original waveform, or on an existing zoom waveform. A rectangle indicates the zoom area.

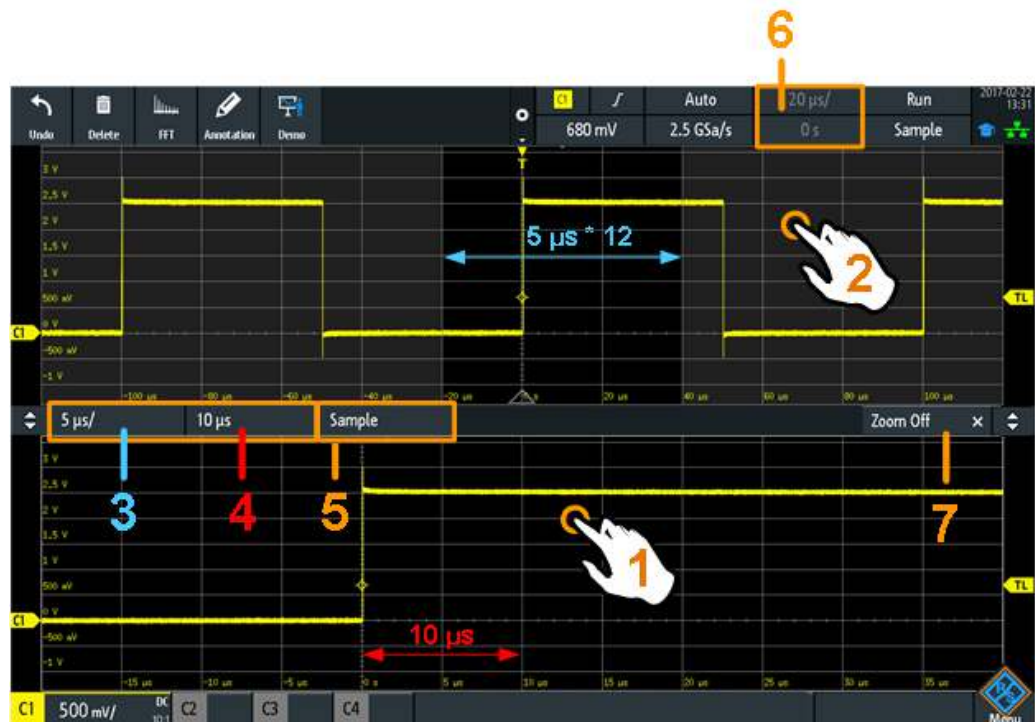

Figure 6-1: Display of horizontal zoom: zoom in bottom window, normal waveform in upper window

- 1 = Tap to activate zoom settings
- 2 = Tap to activate normal waveform settings
- 3 (blue) = Horizontal zoom scale and width of the zoom area
- 4 (red) = Horizontal zoom position
- 5 = Acquire mode, can be set in zoom window or in the upper status bar
- 6 = Horizontal scale and position of the normal waveform
- 7 = Close zoom window

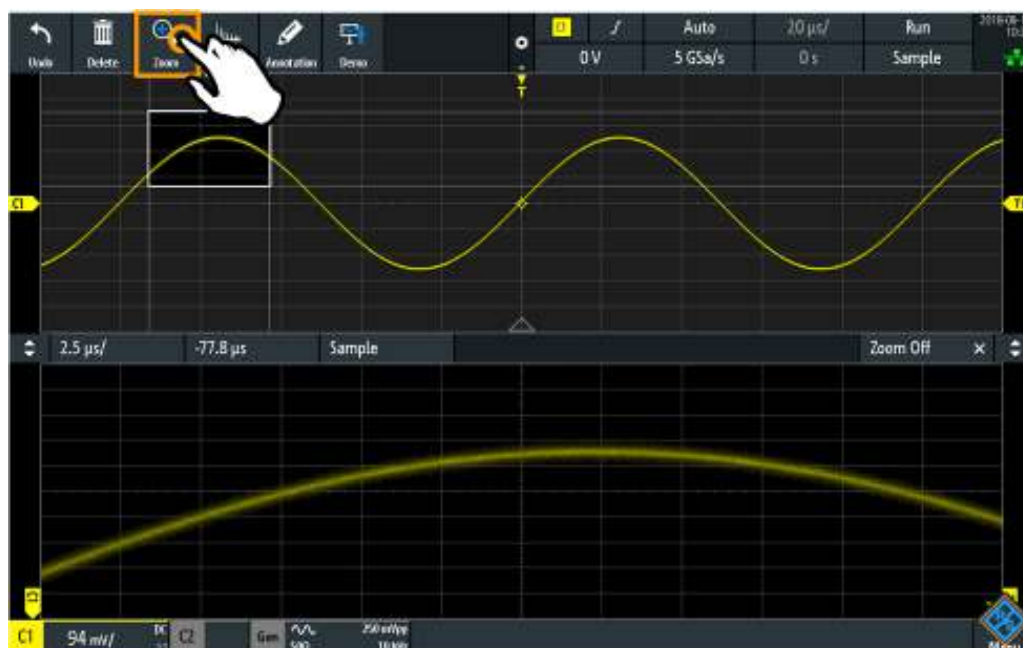

Figure 6-2: Display of vertical zoom

6.1.2 Modifying the Zoom

There are several ways to adjust the zoom:

- Use finger gestures on the screen.
- Use the [Scale] and [Position] knobs.
- Tap the zoom scale or zoom position label in the zoom window and enter a value on the keypad. These settings are horizontal values, which take effect in horizontal and vertical zoom windows. See number 3 and 4 in [Figure 6-1](#).
- Use the menu to enter exact numerical values. See [Chapter 6.1.3, "Zoom Settings"](#), on page 77.

To adjust the zoom using gestures

1. For horizontal and vertical zoom:
 - a) To change the horizontal zoom position, drag one finger horizontally in the zoom window.
 - b) To change the horizontal zoom scale and width of the zoom area, spread or pinch two fingers in horizontal direction.
2. For vertical zoom only:
 - a) To change the vertical zoom position, drag one finger vertically in the zoom window.
 - b) To change the vertical zoom scale and height of the zoom area, spread or pinch two fingers in vertical direction.
3. To change the position of the zoom area in vertical zoom:

Drag the zoom area on the original waveform in the upper window.

To adjust the zoom using the horizontal rotary knobs

1. To set the focus to the zoom window (lower window), tap in the zoom window.
2. For horizontal and vertical zoom:
 - a) To change the horizontal zoom scale and width of the zoom area, turn the horizontal [Scale] scale knob.
 - b) To change the horizontal zoom position, turn the horizontal [Position] knob.
3. For vertical zoom only:
 - a) To change the vertical zoom scale and height of the zoom area, turn the vertical [Scale] scale knob.
 - b) To change the vertical zoom position, turn the [Offset/Position] knob (upper knob in Vertical section).
4. To set the focus to the normal waveform, tap the upper window.
Now the knobs are applied to the normal waveform and adjust time scale and horizontal position of the waveform.

6.1.3 Zoom Settings

Zoom settings are listed in the "Horizontal" menu if the zoom is active.

1. If the zoom is off, activate the zoom.
2. Press the [Horizontal] key.

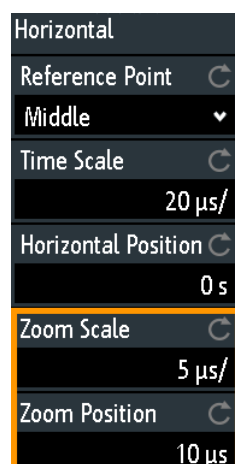

Zoom Scale

Defines the horizontal scale for the zoom window in seconds per division. The scaling determines the width of the zoom area (12 divisions * scaling per division), the time-base of the zoom window. The zoom area is indicated in the original waveform window.

"Zoom Scale" has effect only in horizontal zoom.

Remote command:

`TIMEbase:ZOOM:SCALE` on page 317

Zoom Position

Defines the distance of the trigger point to the reference point in the zoom window. The value determines the position of the zoom area in the upper window.

"Zoom Position" has effect in horizontal and vertical zoom.

Remote command:

`TIMEbase:ZOOM:TIME` on page 317

6.2 Mathematics

A math waveform is a calculated waveform. It is calculated out of one or two analog channels, a constant, or another math waveform using several predefined operations. You can define up to 5 equations. The complete configuration is called equation set and can be saved for later use.

You can analyze math waveforms in the same way as channel waveforms: use zoom, perform automatic and cursor measurements, and save as reference waveform.

When the instrument is in roll mode, some math functions are non-calculable.

6.2.1 Short Menu for Math Waveforms

The math waveform label at the bottom of the screen shows the main settings of the math waveform: sources, operation, unit, and vertical scale. The short menu shows the status of all math waveforms.



- 1 = open short menu
- 2 = display a math waveform
- 3 = select a math waveform for scaling and positioning
- Menu = open the "Mathematics" menu and "Equation Set Editor"
- Off = disable mathematics

6.2.2 Configuring Math Waveforms

1. Press the [Math] key.
The math waveforms are activated, using the latest settings.
2. Press the [Math] key again.
The "Mathematics" menu and the "Equation Set Editor" are shown.
3. Configure the equations of the math waveforms in the "Equation Set Editor". You can define up to 5 equations. The complete configuration is called equation set and can be saved for later use.
 - a) Tap the row of the math waveform that you want to configure.
 - b) To activate the math waveform, set its "State".
 - c) Select the "Operation".
 - d) Select the "Source(s)", the operands of the mathematical equation: 1 or 2 analog channels, constant values or math waveforms. Only math waveforms of lower order are available, for example, M2 can be a source for M3, M4, and M5. For M1, math waveform sources are not available.
 - e) Select the "Unit".
 - f) Optionally, add label to the math waveform. The label is shown at the right edge of the grid.
4. Close the "Equation Set Editor".
5. To adjust vertical scale and position using vertical knobs:
 - a) Select a math waveform in the short menu.
 - b) Use the rotary knobs in the Vertical section of the front panel. See: [Chapter 4.3.1, "VERTICAL Controls"](#), on page 39.
6. To enter exact values for vertical scale and position:
 - a) Open the "Mathematics" menu.
 - b) In the "Equation Set Editor", select a math waveform.
 - c) In the menu, enter "Vertical Scale" and "Position".

6.2.3 Settings for Math Waveforms

In the "Mathematics" menu, you find the general settings for math waveforms. You can:

- Switch mathematics on and off.
- Save configured equations in an equations set file, see [Chapter 6.2.5, "Saving and Loading Formularies"](#), on page 82.
- Load a previously saved equation set.
- Adjust the display of the math waveform that is selected in the "Equation Set Editor":
 - Vertical position
 - Vertical scale

Remote commands:

- `CALCulate:MATH<m>:STATe` on page 318
- `CALCulate:MATH<m>:POSition` on page 320
- `CALCulate:MATH<m>:SCALE` on page 320
- Waveform transfer: see [Chapter 15.9.1.3, "Math Waveforms"](#), on page 405
- History data: see [Chapter 15.6.5.2, "Displaying History Segments"](#), on page 341 and [Chapter 15.6.5.3, "Timestamps"](#), on page 344

6.2.4 Mathematic Functions

When you open the "Mathematics" menu, the "Equation Set Editor" opens in parallel.

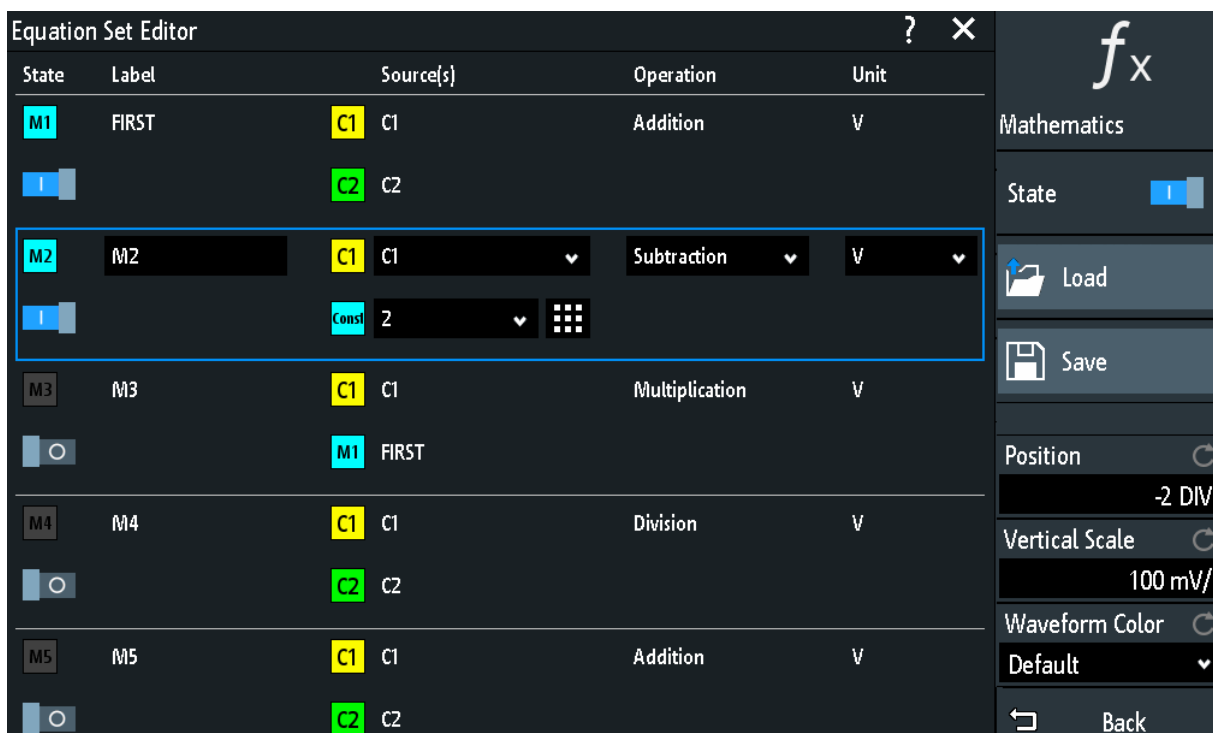

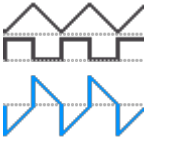

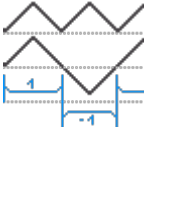
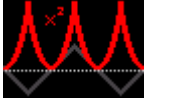

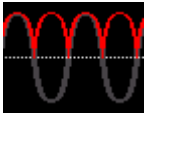
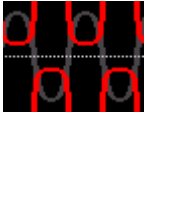



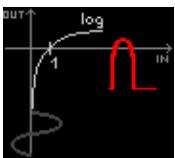
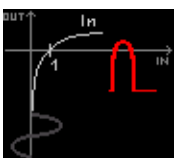

Figure 6-3: Mathematics menu and Equation Set Editor

The "Mathematics" menu is described in [Chapter 6.2.3, "Settings for Math Waveforms"](#), on page 79.

In the "Equation Set Editor", you configure up to 5 math waveforms, set their visibility, and define a label for each waveform. Each equation consists of one or two operands and an operator. An operand (source) can be an input channel, a constant value, or a math waveform with lower number.

The following operations are available:

<p>Addition</p>		<p>Source1 + Source2 Adds the values of 2 sources (channel or math waveform, or constant).</p>
<p>Subtraction</p>		<p>Source1 - Source2 Subtracts the second source from the first source.</p>
<p>Multiplication</p>		<p>Source1 * Source2 Multiplies the two sources.</p>
<p>Division</p>		<p>Source1 / Source2 Divides the first source by the second source. For small amplitudes of the second source, the result increases quickly. If the second source crosses zero, the result would be a range of $+\infty$ to $-\infty$. In this case, instead of 0 V, the calculation function uses the value that the Least Significant Bit (LSB) of the second source represents. (For an 8-bit value, for example, 1/256).</p>
<p>Square</p>		<p>Source1 * Source1 Squares the source. If the source contains negative values that have been clipped, then the result contains positive clipping.</p>
<p>Square Root</p>		<p>Square Root (Source) Calculates the square root of the source. Note that the square root of a negative number is undefined and the result is clipped.</p>
<p>Abs. Value</p>		<p> Source Calculates the absolute value of the source. All negative values are inverted to positive values. The positive values remain unmodified. If the source has negative values that have been clipped, the result contains positive clipping.</p>
<p>Reciprocal</p>		<p>1V / Source Divides 1V by the source values. For small source amplitudes the result increases quickly. If the source crosses zero, the result would be a range of $+\infty$ to $-\infty$. In this case, instead of 0 V, the calculation function uses the value that the Least Significant Bit (LSB) of the operand represents. (For an 8-bit value, for example, 1/256).</p>
<p>Inverse</p>		<p>Inverts all voltage values of the source, i.e. all values are mirrored at the ground level. Thus, a positive voltage offset becomes negative. If the amplitude of the source is clipped, the result is the inverted limitation.</p>

Common Log.		<p>$\log(\text{Source})$</p> <p>Calculates the logarithm to the basis 10 of the source. Note that the logarithm of a negative number is undefined and the result is clipped.</p>
Natural Log.		<p>$\ln(\text{Source})$</p> <p>Calculates the logarithm to the basis e (Euler number) of the source. Note that the logarithm of a negative number is undefined and the result is clipped.</p>
Derivative		<p>$f'(\text{Source})$</p> <p>The derivative corresponds to the rise of the tangent through a function point and indicates the dimension of the change in quantity of the source in time. The larger the quantity change of the operand per time becomes, the larger the result of the derivative is.</p> <p>The calculation is approximated using the secant based on the current calculated value and a value with a distance of 0.1 DIV. Due to this, the time axis has a finitely small resolution. Therefore, scale the input signal to display the required area appropriately.</p>
Integral		<p>Calculates the definite integral of the source.</p> <p>The calculation is displayed in the illustration. The integration starts at point "a" and adds the area beneath the waveform. Point "b" indicates the currently calculated value. At the end of the positive alternation, the integral function reaches its maximum. Due to the homopolar operand used in this example, the waveform of the area reaches zero after the negative alternation.</p> <p>Use a "V-Marker" cursor to measure the area for an extract of the waveform.</p>

Remote command:

- `CALCulate:MATH<m>[:EXPRession] [:DEFine]` on page 319
- `CALCulate:MATH<m>:LABel` on page 319
- `CALCulate:MATH<m>:LABel:STATe` on page 320

6.2.5 Saving and Loading Formularies

You can save equation sets with up to 5 formularies in the internal storage of the instrument, or to USB flash drive, and load them later. Furthermore, you can move or copy saved equation sets from internal storage to USB flash drive, and vice versa, see [Chapter 9.6, "Export and Import"](#), on page 164.

To save an equation set

1. In the "Mathematics" menu, tap "Save".
2. Select the "Destination": internal storage or USB, and the directory.
The destination `/USB_FRONT` is only active, if a USB flash drive is connected to the front USB port.

3. Enter the filename.
4. Optionally, enter a comment.
5. Tap "Save".

6.3 Reference Waveforms

To compare waveforms and analyze differences between them, you can display reference waveforms.

Reference waveforms are waveform data stored in the internal reference storages. Four reference waveforms are available and can be displayed: R1 to R4.

The display of a reference waveform is independent from the display of the source waveform; you can change the vertical and also horizontal scales and positions. The current scale values are shown in the waveform label of the reference waveform.

Short menu

The short menu shows the status of all reference waveforms.

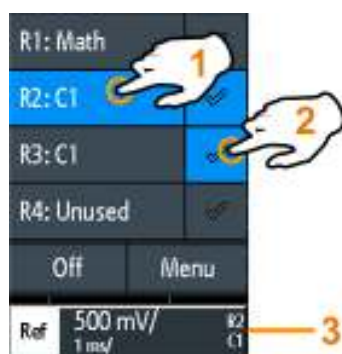

- 1 = select a reference waveform
- 2 = display a reference waveform
- 3 = Reference waveform label with vertical and horizontal scale, reference number and source waveform

File format

Waveforms can be saved as reference waveforms. The file format is TRF. Files can be saved to and loaded from internal memory or external USB flash device.

TRF is the specific binary format for reference waveforms of the R&S RTB2000. It contains the amplitude value of each sample that is displayed on the screen (8 bit or 16 bit long). For peak-detect waveforms, 2 values per sample are saved. The file contains also time information (time of the first sample and the sample interval) and current instrument settings.

The data can be loaded as reference waveform for further use on the instrument. It is not intended for analysis outside the R&S RTB2000.

6.3.1 Using References

To create and display a reference waveform

1. To activate the reference waveform and open the "References" menu, press the [Ref] key twice.
2. To create a reference waveform from an active waveform:
 - a) Select the "Source" waveform.
 - b) Select the target "Reference".
 - c) Tap "Copy"

The new reference waveform is created on top of its origin, and it has the focus.

3. To change the scaling and position, use the horizontal and vertical [Position] and [Scale] knobs.

See also:

- [Chapter 4.3.1, "VERTICAL Controls"](#), on page 39
- [Chapter 4.4.1, "HORIZONTAL Controls"](#), on page 49

To save a waveform as reference waveform

You can save any active waveform directly as reference waveform to a file.

1. To open the "References" menu, tap the  menu icon and select "References".
2. Tap "Save Reference".
3. Select the waveform that you want to save: "Source".
4. Tap "Destination".
5. Select the "Location" (internal or USB).
6. If you save the file on USB flash device, you can set a target folder.
 - a) Double-tap the target folder. If the folder does not exist, you can create a new one.
The folder opens.
 - b) Tap "Accept Dir." .
7. If necessary, change the "File Name".
8. Optionally, add a comment.
9. Tap "Save"
10. Close the dialog box.

To load a reference waveform

1. To open the "References" menu, tap the  menu icon and select "References".
2. Select the target "Reference" waveform.
3. Tap "Load Reference".

4. Select the "Location", the folder, and the reference file.
5. Tap "Load".
The instrument writes the waveform data to the selected reference waveform and displays it.

6.3.2 Settings for Reference Waveforms

- ▶ To open the "References" menu:
 - a) Tap the  menu icon in the lower right corner of the screen.
 - b) Scroll down. Select "References".

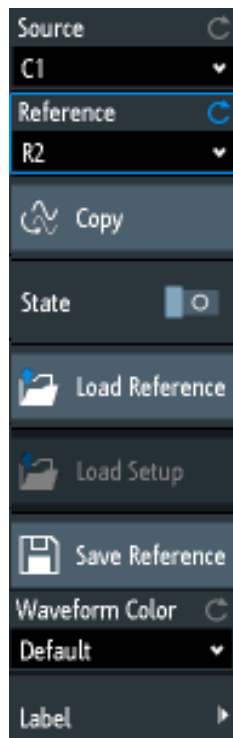

Source.....	86
Reference.....	86
Copy.....	86
State.....	86
Load Reference.....	86
Load Setup.....	86
Save Reference.....	86
Waveform Color.....	87
Label.....	87
L Bit.....	87
L Label.....	87
L Predefined Label.....	87
L Edit Label.....	87

Source

Defines the source of the reference waveform. Any active channel, math or reference waveform can be selected.

Remote command:

[REFCurve<m>:SOURce](#) on page 321

[REFCurve<m>:SOURce:CATalog?](#) on page 321

Reference

Selects one of the four possible reference waveforms.

Copy

Copies the "Source" waveform to the selected reference waveform. The reference waveform is kept until you update it or load another waveform to the reference.

Remote command:

[REFCurve<m>:UPDate](#) on page 322

State

Activates the reference waveform and displays it.

Remote command:

[REFCurve<m>:STATe](#) on page 322

Load Reference

Provides functions to load a reference waveform.

Select the "Location" of the waveform file (internal or USB), and the file. Tap "Load Reference".

You can also delete obsolete files in the dialog box.

Remote command:

[REFCurve<m>:LOAD](#) on page 322

Load Setup

Loads the device settings that were used to obtain the stored reference waveform. The settings are only available if the file was stored to the internal storage and never written to a USB flash device.

Load the reference waveform first, and then the settings. If settings were not stored, "Load Setup" is not active.

Remote command:

[REFCurve<m>:LOAD:STATe](#) on page 323

Save Reference

Opens a dialog box to save a waveform as reference waveform:

- | | |
|---------------|------------------------------------------------------------------------------------------------------------------------------------------------|
| "Source" | Select the waveform to be saved. You can save any active analog channel, math or reference waveform, or logic pod. |
| "Destination" | Select the "Location" (internal directory or USB flash device), and the target directory. |
| "File Name" | Enter the filename. If a file with the same filename already exists in the destination directory, it will be overwritten without notification. |

"Comment" Optionally, enter text to describe the waveform.

"Save" Saves the data.

Remote command:

`REFCurve<m>:SAVE` on page 322

Waveform Color

Selects a color for the reference waveform. The default color is white. You can select another monochrome color, or a color scale.

The color scales are described in "[Waveform Color](#)" on page 45.

Remote command:

`REFCurve<m>:WCOLor` on page 324

Label

Opens a menu to specify user-defined text labels for the individual reference waveforms.

Bit ← Label

Selects the reference waveform for labeling.

Label ← Label

Enables or disables the user-defined label for the selected reference waveform.

Predefined Label ← Label

Selects a predefined label text. You can edit the text with "Edit Label".

Edit Label ← Label

Opens on-screen keypad to enter a label text. If you previously have selected a predefined label, it is already written in the entry line, and you can modify it.

The maximum name length is 8 characters, and only ASCII characters provided on the on-screen keypad can be used.

Remote command:

`REFCurve<m>:LAbel` on page 324

6.4 History and Segmented Memory (Option R&S RTB-K15)

Using the history and segmented memory, you can access the data of previously acquired waveforms and analyze them. For example, you can analyze signals that occur in short bursts with long idle times, packet communication on serial buses, radar pulses, and laser pulses. The segmented memory is used to store the waveforms and provides a segment table to analyze the stored waveforms.

You can analyze history segments in the same way as the waveform of the latest acquisition. All R&S RTB2000 measurement and analysis tools are available: zoom, cursor measurements, quick and automatic measurements, mask test, serial protocol analysis, mixed-signal functions and so on.

The segment table and the waveform data of history segments can be saved to file.

The fast segmentation mode reduces the blind time of the acquisition.

6.4.1 Segmented Memory

If an acquisition runs, the instrument stores the captured data in the memory, processes the data and displays the waveform. The segmented memory keeps the data of the displayed waveform and also the data of the waveforms that have been captured before. Each stored waveform is called a segment. The record length of the segments can be defined. The number of segments depends on the record length. The shorter the record length, the more segments can be saved.

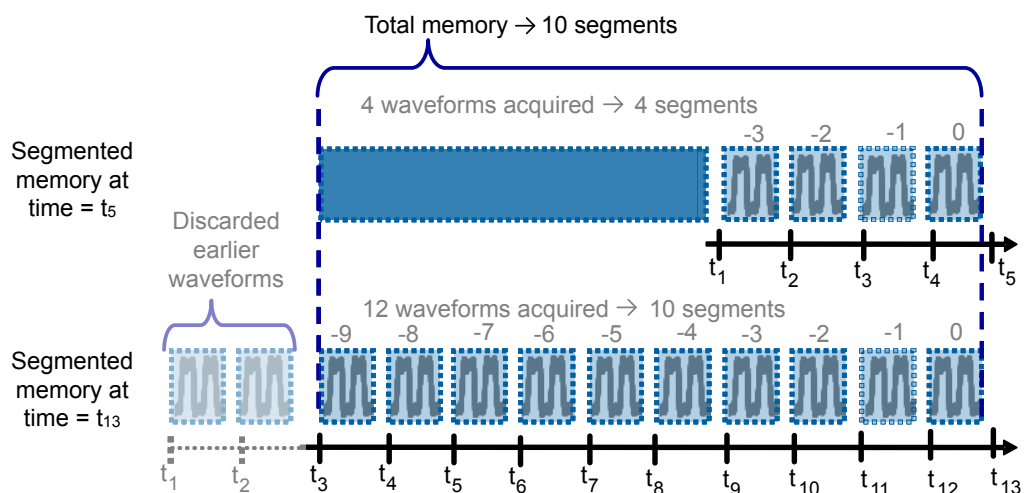

Figure 6-4: Segmented memory. In this example, the memory can store 10 segments.

Each segment has a timestamp time to identify when the events took place.

The history can access the stored segments and display them. When you start a new acquisition, the memory is cleared and the segments are written anew.

The history stores the following data during acquisition:

- All active analog channels.
- All logic channels if at least one logic is active (with option R&S RTB-B1).
- Decoded bus data if the bus is active (with at least one serial protocol option, for example, R&S RTB-K1 or -K2).

Fast segmentation

During normal acquisitions, only a short time of the acquisition cycle is used for sampling; processing and display take most of the time. The processing and display time is blind time causing a gap in the recorded signal. Usual acquisitions can miss very short-time and infrequent events occurring during the dead time.

To reduce the dead time and thus the probability of missed events, fast segmentation is provided.

With fast segmentation, subsequent triggered acquisitions are captured very fast, with hardly any dead time between the acquisitions. After the acquisition of all segments has been completed, the data is processed and the latest waveform is displayed. Using the history viewer, you can view and analyze all stored waveform segments.

6.4.2 Activating the History

To activate the history

1. Tap the "Menu" icon.
2. Select "History".
3. Enable "Show History".

The segment table and the history player are shown.

4. Stop the acquisition.

The captured segments are listed in the segment table, and the buttons in the history player are active.

To disable the history

- ▶ In the history player, tap "Exit".

If you close only the segment table, you can use the history player and see the waveform segments in greater detail. To open the segment table again, open the "History" menu, and tap "Show History".

6.4.3 History Settings

History and segmentation settings are located in the "History" menu. The "Acquisition" provides an additional setting: "Nx Single".

1. Activate the history.
2. If you want to set an individual record length or segment number, disable "Auto".
If "Auto" is enabled, the record length is selected in the "Acquisition" menu.

3. Set the "Record Length", or "No. of Segments".

The record length and the number of segments are interdependent, if one parameter is set, the other is adjusted by the instrument.

4. If necessary, enable [Fast Segmentation](#).
5. Set the number of waveforms to be captured by a [Single] acquisition:
 - a) Press the [Acquisition] key.
 - b) Set [Nx Single](#).

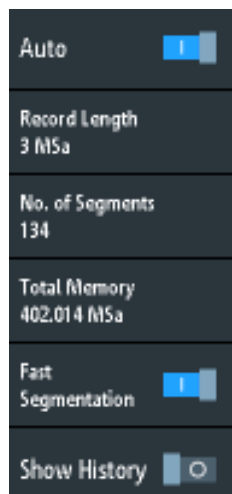

The "History" menu has the following settings:

Auto

Defines how the record length and number of segments are set: automatically by the instrument, or by setting the record length or number of segments manually.

In automatic mode, you can adjust the record length in the "Acquisition" menu. Automatic setting of the number of segments takes effect only if auto trigger is set. When you change from auto to normal trigger mode, the current segment size remains.

Remote command:

[ACQUIRE:MEMORY\[:MODE\]](#) on page 338

Record Length

Shows or sets the record length, depending on the selected "Auto" mode. Record length is the number of waveform samples that are stored in one waveform record. The number of available history segments is adjusted automatically.

Remote command:

[ACQUIRE:POINTS:AUTOMATIC](#) on page 301

[ACQUIRE:POINTS\[:VALUE\]](#) on page 301

No. of Segments

Shows or sets the number of history segments in the memory, depending on the selected "Auto" mode. The record length is adjusted accordingly. When you change the number of segments, the history is deleted.

See also: [Chapter 6.4.1, "Segmented Memory"](#), on page 88

Fast Segmentation

If enabled, the acquisitions are performed as fast as possible, without processing and displaying the waveforms. When acquisition has been stopped, the data is processed and the latest waveform is displayed. Older waveforms are stored in segments. You can display and analyze the segments using the history.

See also: [Chapter 6.4.1, "Segmented Memory"](#), on page 88

Remote command:

[ACquire:SEGmented:STATe](#) on page 340

Show History

Enables or disables the history.

6.4.4 Segment Table and History Player

The memory segments are continuously written when an acquisition is running. When you activate the history, the segment table opens but it is empty when the acquisition is running. When you stop the acquisition, the captured segments are listed in the segment table, and the history player becomes active.

The segment table shows the index and timestamp of all history segments, and whether the segment was captured on a trigger event or in auto mode. Below the table, you find the history player with functions to view the segments that are stored in the memory.

The history segments store the data of the currently active channels. You can acquire several channels at once, and display and analyze the channels individually.

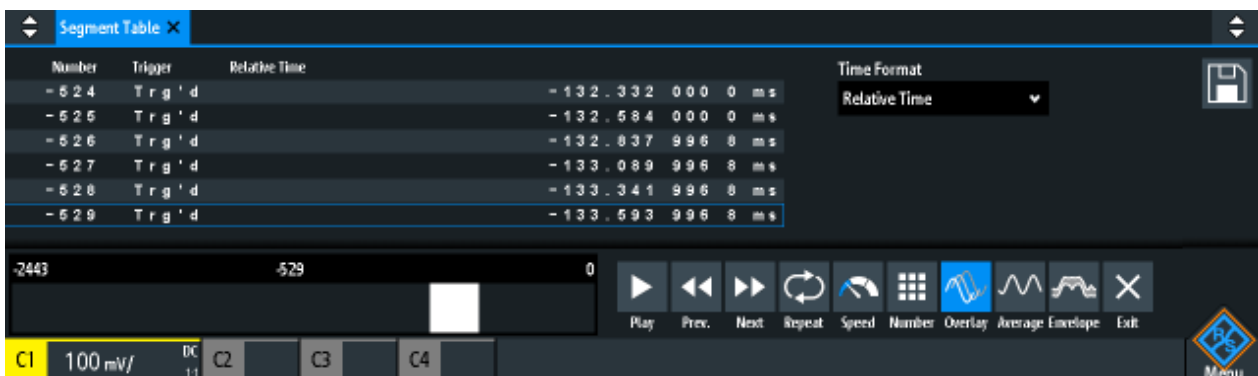

You can show all history segments in sequence, or display a single segment.

To display history segments

1. Activate the history.
2. Stop the acquisition.
3. Set the "Time Format" to be shown in the table: absolute or relative time.
4. Set the "Speed".
5. To play all segments once, tap "Run".
6. To play all segments repeatedly:
 - a) Enable the "Repeat" button.
 - b) Tap "Run".
7. To access a particular segment, you can:
 - Tap the segment in the segment table.

- Drag the slider until the required segment number is shown.
 - Tap "Number" and enter the segment number. The newest segment has always the number "0". Older segments have a negative number.
 - Use "Prev." and "Next" to show the adjacent segment.
8. If the history segments contain the data of several channels and you want to analyze only one or several channels, disable all channels that you do not need.

Functions in the segment table and history player

Time Format

Sets the format of the timestamp. The timestamp shows the time of the currently displayed history segment. Thus, the time relation between acquisitions is always available. More precisely, the timestamp is the time of the trigger event.

The timestamp can be absolute or relative:

- Absolute: Date and daytime of the trigger event of the displayed segment. Depending on the horizontal position, the waveform can be captured up to 100,000 seconds after the trigger event, and thus after the displayed timestamp. The instrument considers this delay automatically, all measurements are related to the trigger event.
- Relative: time difference of the current segment to the newest segment (index = 0).

Remote command:

[Chapter 15.6.5.3, "Timestamps"](#), on page 344

Save

Saves the segment table to a CSV file on a connected USB flash drive. The file contains all timestamps: relative time, time to previous, and absolute time. To save the waveform segments, use [Save Load] key > "Waveforms".

See also: [Chapter 6.4.5, "Exporting History Data"](#), on page 93.

Remote command:

`EXPort:ATABLE:NAME` on page 348

`EXPort:ATABLE:SAVE` on page 349

Play

Starts and stops the playback of the history segments.

Remote command:

`...:HISTory:PLAYer:STATe`

Prev.

Steps back to the next older segment.

Next

Steps forward to the next newer segment.

Repeat

If selected, the playback of the selected history segments repeats automatically.

Remote command:

`...:HISTory:REPLay`

Speed

Sets the speed of the history playback: automatic, slow, middle, or fast.

Remote command:

```
...:HISTory:PLAYer:SPEed
```

Number

Accesses a particular history segment in the memory to display it. The newest acquisition segment has always the index "0". Older segments have a negative index. You can also drag the slider, which is above the icons. The current segment is shown in the index bar.

Remote command:

```
...:HISTory:CURRent
```

Overlay

Displays the segments with infinite persistence. Thus, you can see all data points of all displayed segments of a player cycle.

Average

Calculates and displays the average of the current segment and the segments before. At the newest segment, the average of all segments is shown. Player restart resets the average calculation. Average requires a stable, triggered and repetitive signal.

Envelope

Displays the envelope that is built from the maximum and minimum values of the current segments and the segments before. At the newest segment, the envelope of all segments is shown. Player restart resets the envelope calculation.

Exit

Disables the history, and closes the segment table and the history player.

6.4.5 Exporting History Data

Data of history segments can be saved to files on a USB flash drive even if the history is not active ("Show History" is disabled). You can select to save all visible channels, or one channel. In addition, you can save the complete time information of the segment table.

6.4.5.1 Saving History to File

Before you can save history data, acquire the waveform and activate the history, so that the segment table is visible.

To save the waveform history segments

1. Connect a USB flash drive to the instrument.
2. Press the [Save Load] key.
3. Select "Waveforms" in the menu.

4. Under "Points", select "History Data".
5. Under "Source", select whether you want to store all visible channels, or one of them.
6. Enter the "File Name". This name is the name of the folder that contains the segment files.
The file format is CSV.

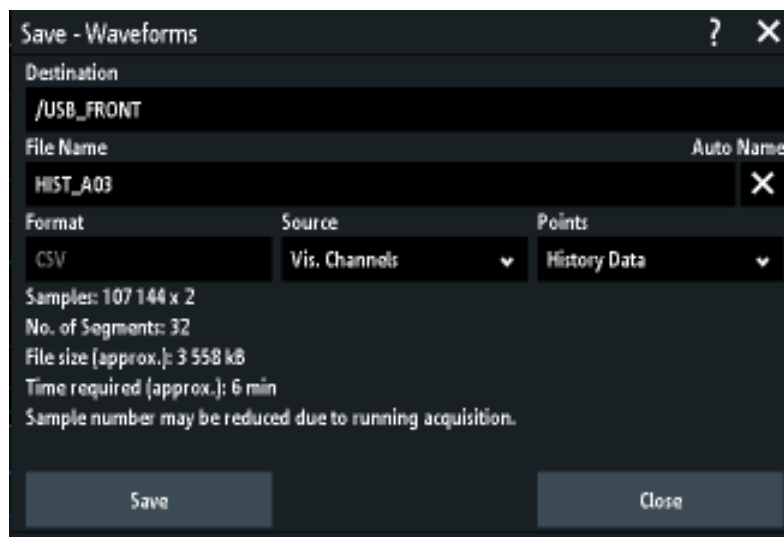

7. To select the target folder, tap the "Destination" field.
The location is always "/USB_FRONT", saving to internal storage is not provided.
8. Tap "Save".
A message shows the progress of the saving process.
9. Close the dialog box.

To save the segment table

1. Connect a USB flash drive to the instrument.
2. In the segment table window, tap "Save".
3. To select the target folder, double-tap it.
4. Tap "New File".
5. Enter the filename.
6. Tap "Enter".
The file is saved immediately, and the window is closed.

6.4.5.2 File Organization and Content

The segment table and history segments are saved to CSV files.

Segment table

The segment table file contains all information that is shown in the table, and also all timestamps: relative time, time to previous, and absolute time.

1		Date	Time				
2	Start of Acquisition	2017-10-13	13:55:19				
3	Last Acquisition	2017-10-13	13:55:27				
4	Acquisitions		53				
5	Number	Relative Time	Time to Previous	Date	Time		Trigger
6		0-0.00000000000000E+00	5.029015392000000E-01	2017-10-13	13:55:27	0.0000000000E+00	Auto
7		-1-5.029015392000000E-01	1.234122592000000E-01	2017-10-13	13:55:26	4.9709846080E-01	Trig'd
8		-2-6.263137984000000E-01	1.004664000000000E-02	2017-10-13	13:55:26	3.7368620160E-01	Trig'd
9		-3-6.363604384000000E-01	1.001169600000000E-02	2017-10-13	13:55:26	3.6363956160E-01	Trig'd

Figure 6-5: Content of a segment table file

Waveforms

Each history segment is saved to a separate file, and all segment files are written to a folder that contains only the files of the saved acquisition. You can specify the name of the folder. The names of the data files include the segment index.

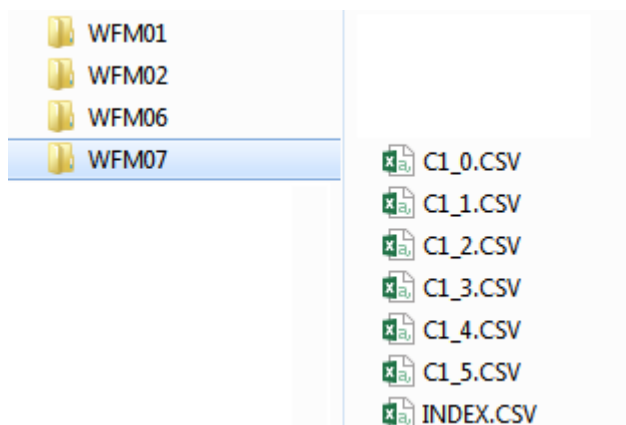

Figure 6-6: Content of a history waveform folder

The data files contain the time and voltage data of the samples. If you save all visible channels, the voltages of all channels are written into one file.

in s,C1 in V,C2 in V
-3.00000E-04,-5.518E-03,2.540E-01
-2.99994E-04,-6.982E-03,2.510E-01
-2.99989E-04,-6.982E-03,2.515E-01
-2.99983E-04,-6.982E-03,2.510E-01
-2.99978E-04,-6.006E-03,2.515E-01
-2.99972E-04,-6.982E-03,2.530E-01
-2.99966E-04,-9.424E-03,2.505E-01
-2.99961E-04,-6.982E-03,2.500E-01
-2.99955E-04,-6.494E-03,2.544E-01
-2.99950E-04,-5.518E-03,2.505E-01

Figure 6-7: Content of a history segment file, two channels are saved

In addition to the data files, an index file is written. The index file delivers information on the files and the segments. For each segment, the segment index, save date and time, and the filename is listed.

Number	Date	Time	Thousandths in ms	Filename
0	2017-04-18	16:18:10	0.000000000e0	C1_0.CSV
-1	2017-04-18	16:18:09	994.600019200e-3	C1_1.CSV
-2	2017-04-18	16:18:09	989.699993600e-3	C1_2.CSV
-3	2017-04-18	16:18:09	984.800000000e-3	C1_3.CSV
-4	2017-04-18	16:18:09	979.499961600e-3	C1_4.CSV
-5	2017-04-18	16:18:09	974.599961600e-3	C1_5.CSV

Figure 6-8: Content of a history index file

6.5 Search

6.5.1 Search Conditions and Results

The search functions of R&S RTB2000 can find all edges, pulse widths, peaks, or other events in an acquisition that match the search conditions. For each search type, specific settings are available. Searches can be performed on channel, math or reference waveforms, available sources depend on the search type.

To configure the search

1. Press the [Search] key.
2. Select the waveform that you want to search for events: "Source".
3. Select the event type that you want to find: "Search Type".
4. Configure the search conditions: "Setup".

The found events and the search conditions are shown in the result table at the bottom of the display. The table shows the following result values: result number, time value, and optional value depending on the search type (voltage, width).

During running acquisition, the results in the table are updated continuously, and the events are marked at the top of the diagram by a brown triangle outline.

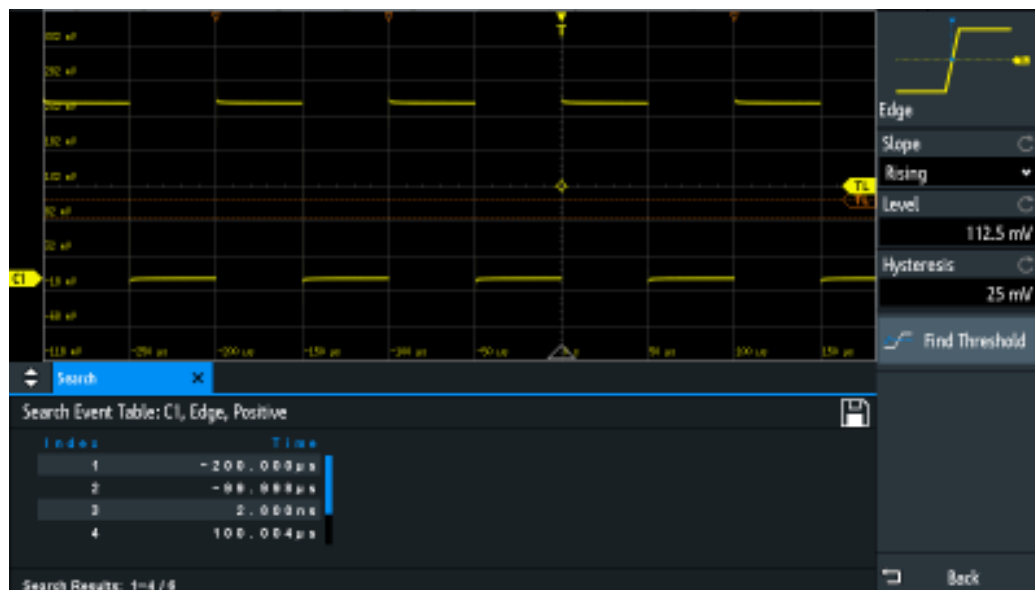

Figure 6-9: Search results and settings during running acquisition

Remote commands to get search results:

- [SEARCH:RCOUNT?](#) on page 338
- [SEARCH:RESULT:ALL?](#) on page 337
- [SEARCH:RESULT<n>?](#) on page 337
- [SEARCH:RESDiagram:SHOW](#) on page 336
- [SEARCH:RESULT:BCOUNT?](#) on page 336

To display search results

When the acquisition is stopped, you can browse the search results.

1. Stop the acquisition.
2. Tap the search result that you want to analyze. If necessary, scroll the list.
The selected event is marked by a filled triangle and a magnifying glass.

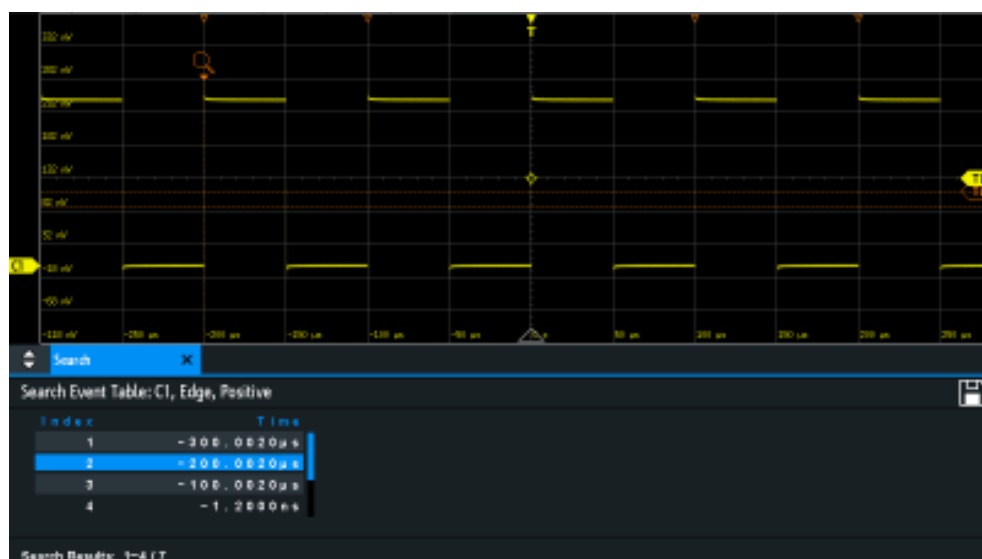

- In the "Search" menu, select "Track event".

The selected event is moved to the reference point. If you select another event, it is shown at the same position.

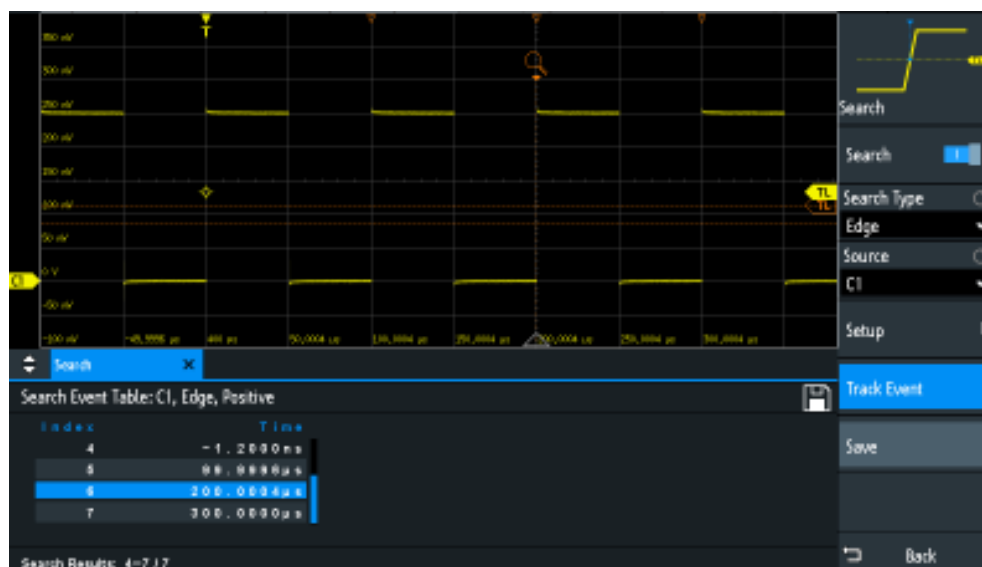

To save search results

- In the upper right corner of the search result table, tap the "Save" symbol.
- Connect a USB flash drive if you want to save the data outside the instrument.
- Select the correct "Destination" and the path.
You can also store the data on the instrument. Therefore, select the "Destination" "/INT/SEARCH".
- If necessary, change the filename and enter a comment.

5. Tap "Save".

The data is saved to a CSV file.

6.5.2 General Search Settings

General search settings are independent of the search type. They are described in the current section. The specific settings for individual search types are described in the following sections.

- ▶ To open the "Search" menu, press the [Search] key.

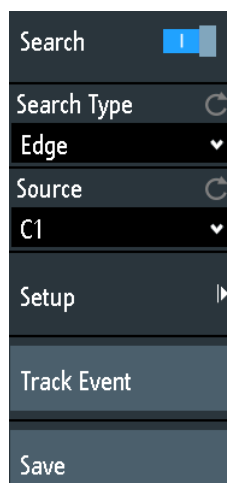

Search

Enables and disables the search mode.

Remote command:

[SEARCh:STATe](#) on page 325

Search Type

Selects the event type you want to search for.

- | | |
|---------|---------------------------------------------------------------------------------------------------------------------------------------------------------------------------------------------------------------------------------------------------------------------------------|
| "Edge" | Similar to the edge trigger, an edge search result is found when the waveform passes the given level in the specified direction.
For settings, see Chapter 6.5.3, "Edge Search" , on page 101. |
| "Width" | The width search finds pulses with an exact pulse width, or pulses shorter or longer than a given time, or pulses inside or outside the given time range. It is similar to the width trigger.
For settings, see Chapter 6.5.4, "Width Search" , on page 102. |
| "Peak" | The peak search finds pulses exceeding a given peak-to-peak value.
For settings, see Chapter 6.5.5, "Peak Search" , on page 103. |

- "Rise/Fall time" The rise or fall time search finds slopes with an exact rise or fall time, or rise/fall times shorter or longer than a given limit, or rise/fall times inside or outside a given time range.
For settings, see [Chapter 6.5.6, "Rise/Fall Time Search"](#), on page 103.
- "Runt" The runt search finds pulses lower than normal in amplitude. In addition, you can define a time limit for the runt.
For settings, see [Chapter 6.5.7, "Runt Setup"](#), on page 105.
- "Data2Clock" The Data2Clock search - also known as setup/hold - finds violation of setup and hold times. It analyzes the relative timing between two signals: a data signal and the synchronous clock signal.
For settings, see [Chapter 6.5.8, "Data2Clock"](#), on page 106.
- "Pattern" The pattern search finds logical combinations of channel states inside or outside a specified time range. For each channel, its state and threshold level is defined. The states are combined logically, and the time of true pattern results is compared with a specified time range.
For settings, see [Chapter 6.5.9, "Pattern Search"](#), on page 108.
- "Protocol" The protocol search finds various events in decoded data serial signals. The events are protocol-specific and correspond to the trigger settings of the serial protocol.

Remote command:

[SEARCh:CONDition](#) on page 325

Source

Selects the waveform to be analyzed by search. Available sources depend on the selected search type.

Edge, width and pattern search you can perform on analog and logic channels. Peak, rise/fall and runt search are possible on active analog channels, math and reference waveforms. For Data2Clock search, you need two active analog channels.

For protocol search, select the configured bus.

Remote command:

[SEARCh:SOURce](#) on page 326

Setup

Opens a menu to define the search parameters for the selected search type.

Track event

If enabled, the selected result is moved to the reference point. Thus you can always see the selected event in the diagram.

Save

Opens a dialog box to save the search results. The file format is CSV.

Remote command:

[EXPort:SEARCh:NAME](#) on page 338

[EXPort:SEARCh:SAVE](#) on page 338

6.5.3 Edge Search

Similar to the edge trigger, an edge search result is found when the waveform passes the given level in the specified direction.

► [Search] > "Search Type" = "Edge" > "Setup"



Slope

Sets the slope to be found: rising, falling, or both slopes.

Remote command:

[SEARCh:TRIGger:EDGE:SLOPe](#) on page 326

Level

Sets the voltage level for the search. To let the instrument set the level, tap "Find Threshold".

Remote command:

[SEARCh:TRIGger:EDGE:LEVel](#) on page 326

Hysteresis

Sets a hysteresis range to the search level to avoid unwanted search results caused by noise oscillation around the level. To let the instrument set the hysteresis, tap "Find Threshold".

For a rising edge, the hysteresis is below the search level. Otherwise, for a falling edge the hysteresis is above the level.

Remote command:

[SEARCh:TRIGger:EDGE:LEVel:DELTA](#) on page 327

Find Threshold

Analyzes the signal, sets the level to 50% of the signal amplitude, and also sets the hysteresis.

6.5.4 Width Search

The width search finds pulses with an exact pulse width, or pulses shorter or longer than a given time, or pulses inside or outside the allowable time range. It is similar to the width trigger.

► [Search] > "Search Type" = "Width" > "Setup"



Polarity

Indicates the polarity of the pulse to be searched for.

Remote command:

[SEARCH:TRIGGER:WIDTH:POLARITY](#) on page 327

Level

Sets the voltage level on which the pulse width is measured. To let the instrument set the level, tap "Find Threshold".

Remote command:

[SEARCH:TRIGGER:WIDTH:LEVEL](#) on page 327

Hysteresis

Sets a hysteresis range to the search level to avoid unwanted search results caused by noise oscillation around the level. To let the instrument set the hysteresis, tap "Find Threshold".

Remote command:

[SEARCH:TRIGGER:WIDTH:LEVEL:DELTA](#) on page 327

Comparison

Sets the condition how the measured pulse width is compared with the given limits.

The comparison works like the comparison of the width trigger, see [Chapter 5.5, "Width Trigger"](#), on page 64.

Remote command:

[SEARCH:TRIGGER:WIDTH:RANGE](#) on page 328

Width

Sets the reference pulse width, the nominal value for comparisons.

Remote command:

[SEARCH:TRIGGER:WIDTH:WIDTH](#) on page 328

Variation

Sets a range Δt to the reference "Width" if comparison is set to "Equal" or "Not equal". The instrument finds pulses inside or outside the range width $\pm \Delta t$.

Remote command:

[SEARCH:TRIGGER:WIDTH:DELTA](#) on page 328

6.5.5 Peak Search

The peak search finds pulses exceeding a given peak-to-peak value (magnitude).

► [Search] > "Search Type" = "Peak" > "Setup"

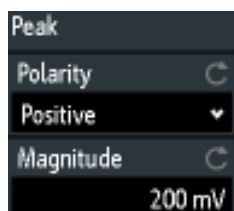

Polarity

Indicates the polarity of the pulse to be searched for a peak.

Remote command:

[SEARCH:MEASURE:PEAK:POLARITY](#) on page 329

Magnitude

Sets the peak-to-peak limit. If the signal exceeds this limit, a search event is listed.

Remote command:

[SEARCH:MEASURE:LEVEL:PEAK:MAGNITUDE](#) on page 329

6.5.6 Rise/Fall Time Search

The rise or fall time search finds slopes with an exact rise or fall time, or rise/fall times shorter or longer than a given limit, or rise/fall times inside or outside the allowable time range.

► [Search] > "Search Type" = "Rise/Fall Time" > "Setup"



Edge

Sets the slope to be found:

- "Rising" to search for rise time
- "Falling" to search for fall time
- "Both" to search for rise and fall time

Remote command:

[SEARCh:TRIGger:RISetime:SLOPe](#) on page 329

Upper Level, Lower Level

Set the upper and lower voltage thresholds. When the signal crosses the first level, the rise/fall time measurement starts. It stops when the signal crosses the second level. To let the instrument set the levels, tap "Find Threshold".

Remote command:

[SEARCh:TRIGger:LEVel:RISetime:LOWer](#) on page 329

[SEARCh:TRIGger:LEVel:RISetime:UPPer](#) on page 329

Comparison

Sets how the measured rise or fall time is compared with the given limits.

- | | |
|----------------|-----------------------------------------------------------------------------------------------------------------------------------------------------------------------------------------------------|
| "Greater than" | Finds rise/fall times longer than the given "Rise/Fall Time". |
| "Lower than" | Finds rise/fall times shorter than the given "Rise/Fall Time". |
| "Equal" | Finds rise/fall times equal to the reference "Rise/Fall Time" if "Variation" $\Delta t = 0$.
If "Variation" $\neq 0$, the setting finds rise/fall times within the range time $\pm \Delta t$. |
| "Not equal" | Finds rise/fall times unequal to the reference value if "Variation" $\Delta t = 0$.
If "Variation" $\neq 0$, the setting finds rise/fall times outside the range time $\pm \Delta t$. |

Remote command:

[SEARCh:TRIGger:RISetime:RANGe](#) on page 330

Rise/Fall Time

Sets the reference rise or fall time, the nominal value for comparisons.

Remote command:

[SEARCh:TRIGger:RISetime:TIME](#) on page 330

Variation

Sets a range Δt to the reference "Rise/Fall Time" if comparison is set to "Equal" or "Not equal". The instrument finds rise/fall times inside or outside the range width $\pm \Delta t$.

Remote command:

[SEARCh:TRIGger:RISetime:DELTA](#) on page 330

6.5.7 Runt Setup

The runt search finds pulses lower than normal in amplitude. The amplitude crosses the first threshold twice without crossing the second one. In addition to the threshold amplitudes, you can define a time limit for the runt in the same way as for width search: runts with exact width, shorter or longer than a given time, or runts inside or outside the allowable time range.

► [Search] > "Search Type" = "Runt" > "Setup"



Polarity

Indicates the polarity of the pulse to be searched for.

Remote command:

[SEARCh:TRIGger:RUNT:POLarity](#) on page 331

Upper Level

Sets the upper voltage threshold for runt detection. A negative runt crosses the upper level twice without crossing the lower level.

Remote command:

[SEARCh:TRIGger:LEVel:RUNT:UPPer](#) on page 331

Lower Level

Sets the lower voltage threshold for runt detection. A positive runt crosses the lower level twice without crossing the upper level.

Remote command:

[SEARCh:TRIGger:LEVel:RUNT:LOWer](#) on page 331

Comparison

Sets the condition how the measured runt width is compared with the given limits.

The comparison works like the comparison of the width trigger, see [Chapter 5.5, "Width Trigger"](#), on page 64.

Remote command:

[SEARCh:TRIGger:RUNT:RANGe](#) on page 331

Width

Sets the reference runt pulse width, the nominal value for comparisons.

Remote command:

[SEARCh:TRIGger:RUNT:WIDTh](#) on page 332

Variation

Sets a range Δt to the reference "Width" if comparison is set to "Equal" or "Not equal". The instrument finds pulses inside or outside the range width $\pm \Delta t$.

Remote command:

[SEARCh:TRIGger:RUNT:DELTA](#) on page 332

6.5.8 Data2Clock

The Data2Clock search - also known as setup/hold search - finds violation of setup and hold times. It analyzes the relative timing between two signals: a data signal and the synchronous clock signal.

Many systems require, that the data signal must be steady for some time before and after the clock edge. Setup time is the time that the data signal is steady before clock edge. Hold time is the time that the data signal is steady after clock edge.

► [Search] > "Search Type" = "Data2Clock" > "Setup"

The settings for Data2Clock search are provided in two menus. In the "Setup" menu, you define the clock polarity, setup and hold times; and in the "Source Setup" menu you define the waveforms to be used, and the levels and hysteresis for each source.



Clock

Selects the input channel of the clock signal.

Remote command:

[SEARCh:TRIGger:DATatoclock:CSOURCE](#) on page 332

Data

Selects the input channel of the data signal.

Remote command:

[SEARCh:SOURce](#) on page 326

Level

Set the voltage levels for clock and data signals. The crossing of clock level and clock edge defines the start point for setup and hold time. The data level defines the threshold for data transition. To let the instrument set the level, tap "Find Threshold".

Remote command:

[SEARCh:TRIGger:DATatoclock:CLEVEL](#) on page 333

[SEARCh:TRIGger:DATatoclock:DLEVEL](#) on page 333

Hysteresis

Sets a hysteresis range to the search level of the selected signal to avoid unwanted search results caused by noise oscillation around the level. To let the instrument set the hysteresis, tap "Find Threshold".

Remote command:

[SEARCh:TRIGger:DATatoclock:CLEVEL:DELTA](#) on page 333

[SEARCh:TRIGger:DATatoclock:DLEVEL:DELTA](#) on page 333

Polarity

Sets the edge of the clock signal to define the start point for the setup and hold time.

"Rising"	Only positive clock edges are considered.
"Falling"	Only negative clock edges are considered.
"Either"	The clock edges next to the data edge are considered regardless of the clock slope. Use this setting, for example, for signals with double data rate.

Remote command:

[SEARCh:TRIGger:DATatoclock:CEdGe](#) on page 333

Setup Time

Sets the minimum time **before** the clock edge while the data signal must stay steady above or below the data level.

Remote command:

[SEARCh:TRIGger:DATatoclock:STIME](#) on page 333

Hold Time

Sets the minimum time **after** the clock edge while the data signal must stay steady above or below the data level.

Remote command:

[SEARCh:TRIGger:DATatoclock:HTIME](#) on page 333

6.5.9 Pattern Search

For pattern search, up to four analog channels can be used as source. If MSO option R&S RTB-B1 is installed, also digital channels can be included in the pattern. For each channel, you define the state. The states are combined logically, and the time of true pattern results is compared with a specified time range. Thus you can find state transitions inside or outside this time range.

- ▶ Select [Search] > "Search Type" = "Pattern" > "Setup".



Threshold, Hysteresis

Sets the search threshold value for each analog channel. If the signal value is higher than the threshold, the signal state is high. Otherwise, the signal state is considered low.

For each analog channel, set a hysteresis to avoid unwanted search results caused by noise oscillation of the signal.

Remote command:

[SEARCH:TRIGGER:PATTERN:LEVEL<n>](#) on page 335

[SEARCH:TRIGGER:PATTERN:LEVEL<n>:DELTA](#) on page 335

H | L | X, Set All

Defines the pattern by selecting the state "H" (high), "L" (low) or "X" (do not care, the channel does not affect the search) for each active analog and digital channel.

The word length of the pattern depends on the number of available analog and digital channels. Logic channels are only available with MSO option R&S RTB-B1. Use "Set All" to set all channels to the same state.

Remote command:

[SEARCH:TRIGGER:PATTERN:SOURCE](#) on page 334

AND, OR, NAND, NOR

Sets the logical combination of the channel states.

"AND" The required states of all channels must appear in the input signal at the same time.

"OR" At least one of the channels must have the required state.

"NAND" "Not and" operator, at least one of the channels does not have the required state.

"NOR" "Not or" operator, no channel has the required state.

Remote command:

[SEARCH:TRIGGER:PATTERN:FUNCTION](#) on page 334

Comparison

Sets the condition how the duration of a steady pattern is compared with the given limit. The three settings "Width" "Variation" and "Comparison" define the time range how long the true result of the state pattern must be valid.

The comparison works like the comparison of the width trigger, see [Chapter 5.5, "Width Trigger"](#), on page 64.

Remote command:

[SEARCH:TRIGGER:PATTERN:WIDTH:RANGE](#) on page 335

Width

Sets the limit time of a steady pattern, the nominal value for comparisons.

Remote command:

[SEARCH:TRIGGER:PATTERN:WIDTH\[:WIDTH\]](#) on page 336

Variation

Sets a range Δt to the reference "Width" if comparison is set to "Equal" or "Not equal". The instrument finds true results of the state pattern inside or outside the range width $\pm \Delta t$.

Remote command:

[SEARCH:TRIGGER:PATTERN:WIDTH:DELTA](#) on page 336

7 Measurements

7.1 Quick Measurements

Quick measurement performs a set of automatic measurements on the selected input channel. The measurements cannot be configured. The results are displayed directly at the waveform (WF) or in the bottom result line (L) and are updated continuously.

If the instrument detects a period in the signal, the quick measurement measures the first cycle and displays the results. If no period is detected, it measures the complete waveform.

- Press the [QuickMeas] key to activate quick measurement.

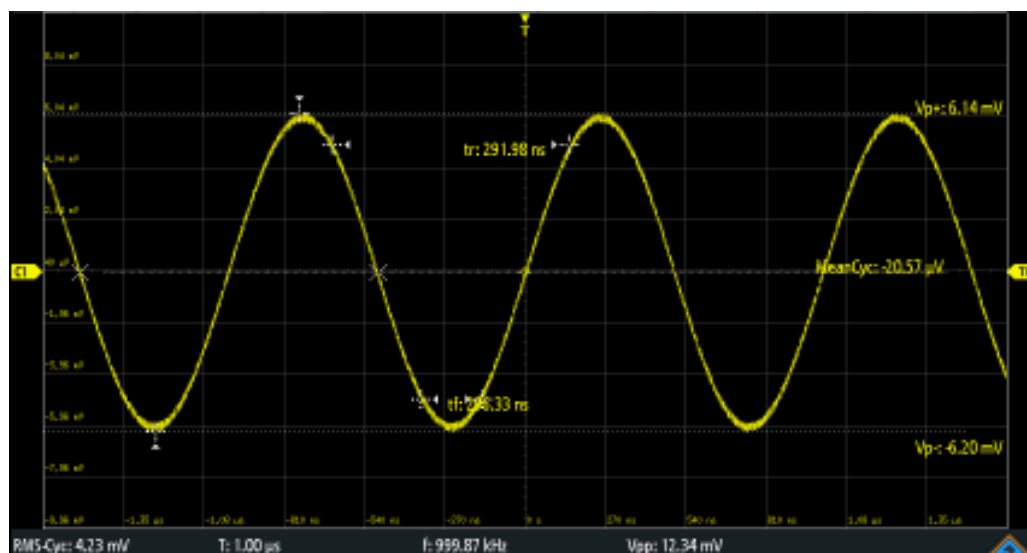

Table 7-1: Results of quick measurement

Label	Description	Display
Vp+	Positive peak value	WF
Vp-	Negative peak value	WF
tr	Rising time of the first rising edge	WF
tf	Falling time of the first falling edge	WF
MeanCyc	Mean value	WF
RMS-Cyc	RMS	L
T	Period length	L
f	Frequency	L
Vpp	Peak to peak value	L

Quick measurement is not available on math and reference waveforms. Channels other than the selected one are switched off in quick measurement mode. When quick measurement is active, cursor measurements are not possible, but you can use automatic measurements in parallel.

- ▶ Press the [QuickMeas] key again to deactivate quick measurement.
The results are deleted on the display.

Remote commands:

- [MEASurement<m>:AON](#) on page 349
- [MEASurement<m>:AOFF](#) on page 350
- [MEASurement<m>:ALL\[:STATe\]](#) on page 350
- [MEASurement<m>:ARESt?](#) on page 350

7.2 Automatic Measurements

You can perform up to 4 different measurements simultaneously.

To configure automatic measurements in the Measure menu

1. Press the [Meas] key.
2. In the menu, select the "Meas. Place", the number of the measurement that you want to configure.
3. If the measurement is off, enable "Measure <n>".
4. Select the measurement type:
 - a) Tap "Type"
 - b) Select the tab of the required measurement category.
 - c) Select the measurement type.

The measurement types are described in [Chapter 7.2.2, "Measurement Types"](#), on page 114.

5. Select the "Source".
The selection list shows all possible sources. If the waveform is not active, it is activated automatically when selected as measurement source.
6. Some measurement types require additional settings. Scroll down the menu, and adjust the additional settings if necessary.
See also: [Chapter 7.2.3, "Settings for Automatic Measurements"](#), on page 118.

7.2.1 Measurement Results

The measurement results are shown in a line below the grid.

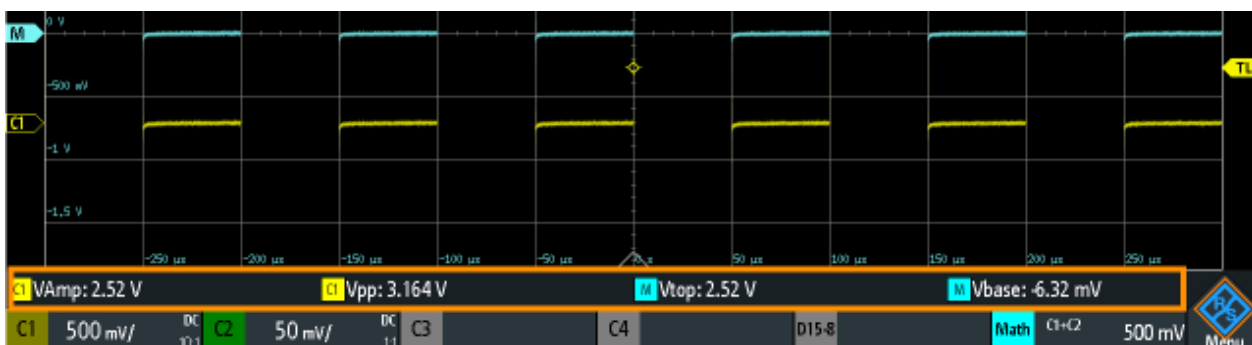

Figure 7-1: Results of four active measurements

If a result cannot be determined, "?" is displayed. Adjust the horizontal and vertical settings if the instrument cannot measure.

If the measurement result is outside the measurement range and clipping occurs, the results are marked with "clipping+" or "clipping-". Adjust the vertical scale to get valid results.

Remote commands are described in:

- [Chapter 15.7.2.2, "Measurements Results"](#), on page 354

7.2.1.1 Statistics

In addition to the current measurement results, you can enable a statistic evaluation. It returns the current, minimum and maximum measurement values, the average and standard deviation, and the number of measured waveforms. The results are shown in a separate tab below the grid. If the cursor measurement is active simultaneously, its results are shown beside the statistic results.

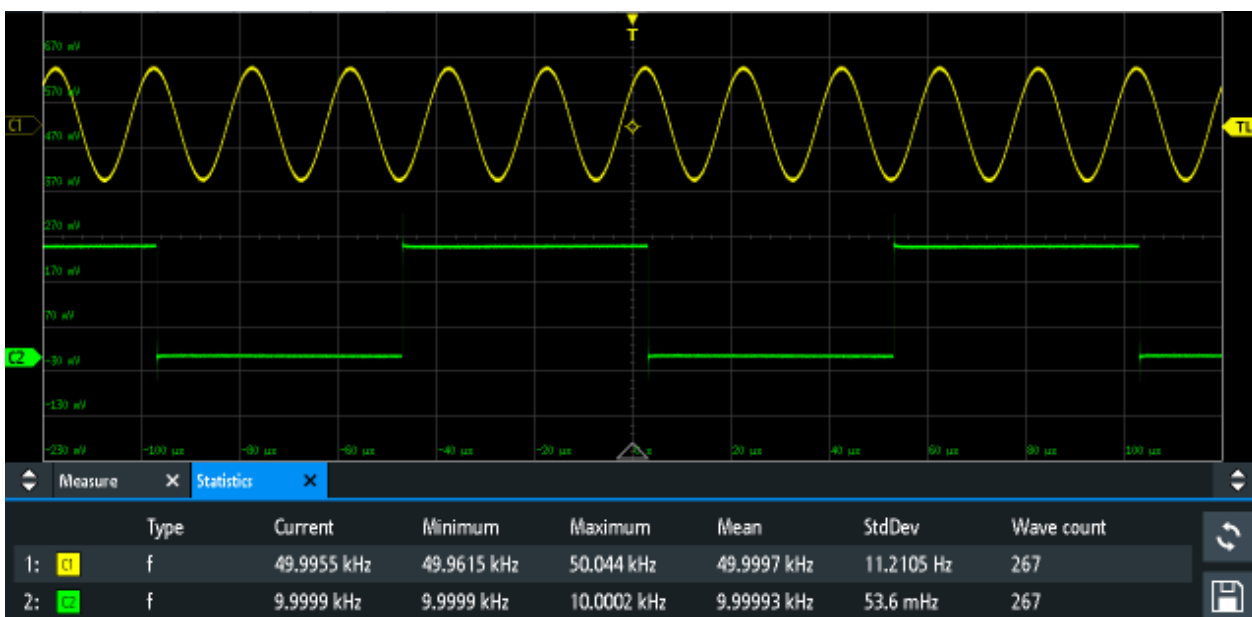

Figure 7-2: Statistic results of four active measurements

1. To delete all measurement results, and to restart statistical evaluation, tap the "Reset" button.
2. To write statistic and measurement results to CSV file, tap the "Save" button.

You can save the statistic results to CSV file for further evaluation. The file contains the statistic values shown on the screen, and also the measurement results of each measured waveform.

9	Meas. Place		1		2
10	Type		Frequency		Frequency
11	Source 1		C1		C2
12	Source 2				
13	Unit		Hz		Hz
14	Upper Level [%]		9,00E+07		9,00E+07
15	Middle Level [%]		5,00E+07		5,00E+07
16	Lower Level [%]		1,00E+07		1,00E+07
17	Wave count		267		267
18	Current		5,00E+10		1,00E+10
19	Average No.		1,00E+09		1,00E+09
20	Minimum		5,00E+10		1,00E+10
21	Maximum		5,00E+10		1,00E+10
22	Mean		5,00E+10		1,00E+10
23	StdDev		1,12E+07		5,35E+04
24	Time of first value				
25	Time of last value				
26	Long term Minimum		5,00E+10		1,00E+10
27	Long term Maximum		5,00E+10		1,00E+10
28	Long term Mean		5,00E+10		1,00E+10
29	Long term StdDev		1,12E+07		5,36E+04
30	Long term start time				
31	Long term end Time				
32					
33					
34	Index	Time Offset	Value	Time Offset	Value
35	1		5,00E+10		1,00E+10
36	2		5,00E+10		1,00E+10
37	3		5,00E+10		1,00E+10
38	4		5,00E+10		1,00E+10
39	5		5,00E+10		1,00E+10
300	...				
301	266		5,00E+10		1,00E+10
302	267		5,00E+10		1,00E+10

Figure 7-3: Exported statistic results, converted to columns with comma delimiter

7.2.2 Measurement Types

The R&S RTB2000 provides many measurement types to measure time and amplitude characteristics, and to count pulses and edges.

7.2.2.1 Horizontal Measurements (Time)

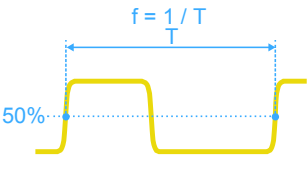
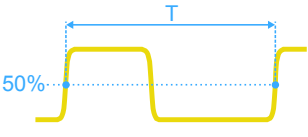
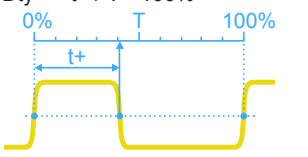
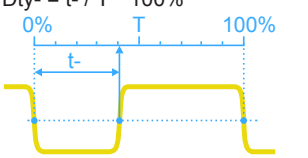
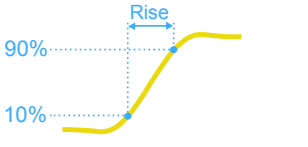
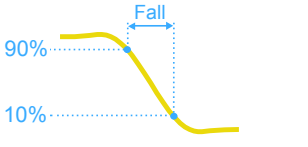
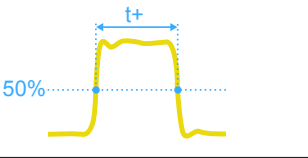
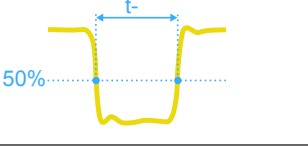
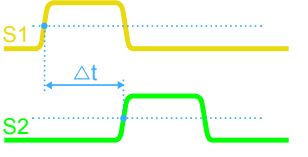
Meas. type	Symbol	Description	Graphic / formula
Frequency	f in Hz	Frequency of the signal, reciprocal value of the measured first period.	
Period	T in s	Time of the first period, measured on the 50% level. The measurement requires at least one complete period of the signal.	
Duty Cycle +	Dty+ in %	Width of the first positive pulse in relation to the period in %. The measurement requires at least one complete period of the signal.	Dty+ = $t+ / T * 100\%$ 
Duty Cycle -	Dty- in %	Width of the first negative pulse in relation to the period in %. The measurement requires at least one complete period of the signal.	Dty- = $t- / T * 100\%$ 
Rise Time	tr in s	Rise time of the first rising edge, the time it takes the signal to rise from the 10% level to the 90% level.	
Fall Time	tf in s	Fall time of the first falling edge, the time it takes the signal to fall from the 90% level to the 10% level.	
Pulse Width +	PW+ in s	Duration of the first positive pulse: time between a rising edge and the following falling edge measured on the 50% level.	
Pulse Width -	PW- in s	Duration of the first negative pulse: time between a falling edge and the following rising edge measured on the 50% level.	
Delay	Dly in s	Time difference between two slopes of the same or different waveforms, measured on the 50% level.	

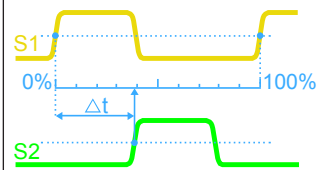
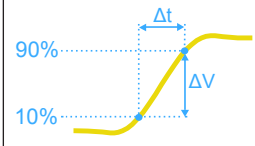
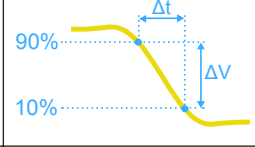
Meas. type	Symbol	Description	Graphic / formula
Phase	Phs in °	Phase difference between two waveforms, measured on the 50% level.	Phase = $\Delta t / T * 360^\circ$ 
Slew rate+	Slewr+	Steepness of the first rising edge, measured between the reference levels 10% and 90%	Slewr+ = $\Delta V / \Delta t$ 
Slew rate-	Slewr-	Steepness of the first falling edge, measured between the reference levels 90% and 10%	Slewr- = $\Delta V / \Delta t$ 
Burst Width	Bst	Duration of one burst, measured on the middle reference level from the first edge to the last edge.	

7.2.2.2 Vertical Measurements (Amplitude)

The unit of most amplitude measurement results depends on the measured source.

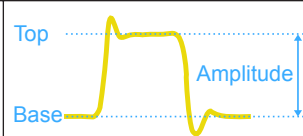
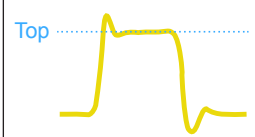
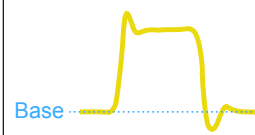
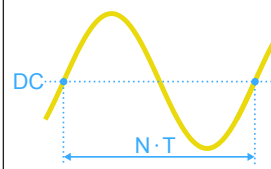
Meas. type	Symbol	Description	Graphic / formula
Amplitude	VAmp	Difference between the top level and the base level of the signal. The measurement requires at least one complete period of the signal.	
Top Level	Vtop	High level of the displayed waveform - the upper maximum of the sample distribution, or the mean value of the high level of a square wave without overshoot. The measurement requires at least one complete period of the signal.	
Base Level	Vbase	Low level of the displayed waveform - the lower maximum of the sample distribution, or the mean value of the low level of a square wave without overshoot. The measurement requires at least one complete period of the signal.	
Mean Cycle	MeanCyc in V	Mean value of the left-most signal period.	

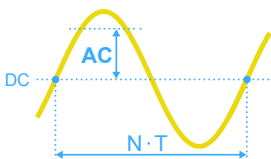
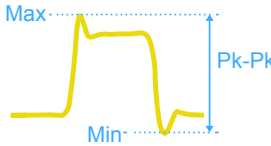
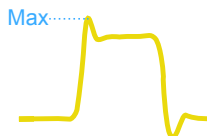
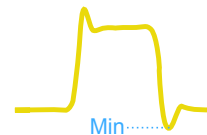
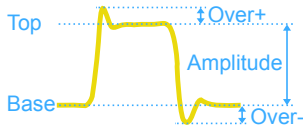
Meas. type	Symbol	Description	Graphic / formula
RMS Cycle	RMS-Cyc in V	RMS (root mean square) value of the voltage of the left-most signal period.	
Peak Peak	Vpp	Difference of maximum and minimum values.	
Peak+	Vp+	Maximum value within the displayed waveform.	
Peak-	Vp-	Minimum value within the displayed waveform.	
Pos. Overshoot Neg. Overshoot	+Ovr -Ovr in %	Overshoot of a square wave after a rising or falling edge. It is calculated from measurement values top level, base level, local maximum, local minimum, and amplitude.	$\text{Over}+ = \frac{\text{Max}_{\text{local}} - \text{Top}}{\text{Amplitude}} \cdot 100\%$ $\text{Over}- = \frac{\text{Base} - \text{Min}_{\text{local}}}{\text{Amplitude}} \cdot 100\%$ 
Mean Value	Mean	Arithmetic average of the complete displayed waveform.	$\text{Mean} = \frac{1}{N} \sum_{k=1}^N x_k$
RMS Value	RMS	RMS (root mean square) value of the voltage of the complete displayed waveform.	$\text{RMS} = \sqrt{\frac{1}{N} \sum_{k=1}^N x_k^2}$
σ -Std. Deviation	σ	Standard deviation of the displayed waveform.	$\sigma = \sqrt{\frac{1}{N-1} \sum_{k=1}^N (x_k - \text{Mean})^2}$

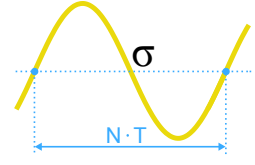
Meas. type	Symbol	Description	Graphic / formula
σ -Std. Dev. Cycle	σ -Cyc	Standard deviation of one cycle, usually of the first, left-most signal period.	
Crest Factor	Crest	The crest factor is also known as peak-to-average ratio. It is the maximum value divided by the RMS value of the displayed waveform.	$\text{Crest} = \frac{\text{Max} x_k }{\text{RMS}}$

7.2.2.3 Counting

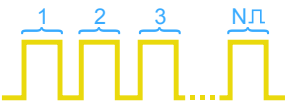
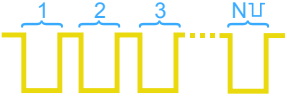
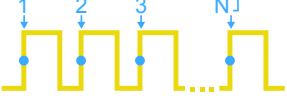
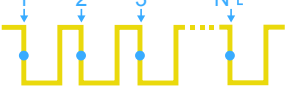
Meas. type	Symbol	Description	Graphic / formula
Positive Pulse	CntP+	Number of positive pulses on the display. The mean value of the signal is determined. If the signal passes the mean value, an edge is counted. A positive pulse is counted if a rising edge and a following falling edge are detected.	
Negative Pulse	CntP-	Number of negative pulses on the display. The mean value of the signal is determined. If the signal passes the mean value, an edge is counted. A negative pulse is counted if a falling edge and a following rising edge are detected.	
Positive Slope	CntS+	Number of rising edges on the display. The instrument determines the mean value of the signal and counts an edge every time the signal passes the mean value in the specified direction.	
Negative Slope	CntS-	Number of falling edges on the display. The instrument determines the mean value of the signal and counts an edge every time the signal passes the mean value in the specified direction.	

7.2.3 Settings for Automatic Measurements

- To open the "Measure" menu, press the [Meas] key.

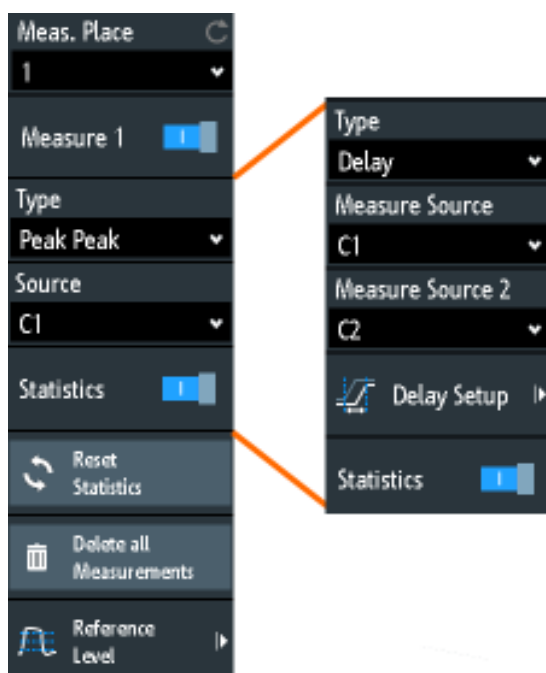

In the measurement menu, you can configure up to 4 parallel measurements (also called measurement places). Available measurement types depend on the type of the selected waveform.

Meas. Place

Selects one of the four available measurement places to be configured or activated.

Measure <n>

Activates or deactivates the selected measurement.

Remote command:

[MEASurement<m>\[:ENABLE\]](#) on page 350

Type

Defines the measurement type to be performed on the selected source. Depending on the type, different results are displayed in the result line.

Select the tab of the required measurement category, and then the measurement type. The "Basic" tab provides the most common measurements: peak to peak, period, frequency, rise time, fall time, mean cycle, and RMS cycle.

Remote command:

[MEASurement<m>:MAIN](#) on page 351

Source

Selects an analog channel, reference or math waveform as the source of the selected measurement. If MSO option R&S RTB-B1 is installed, active digital channels are available as measurement sources.

If the waveform is not active, it is activated automatically when selected as measurement source.

Remote command:

[MEASurement<m>:SOURce](#) on page 353

Measure Source, Measure Source 2

Set the source waveforms for delay and phase measurement, where two sources are required.

Remote command:

[MEASurement<m>:SOURce](#) on page 353

Delay Setup for Measure Source and Measure Source 2

Set the edges to be used for delay measurement. You can measure the delay between two rising edges, two falling edges, between rising and next falling edge, and vice versa.

Remote command:

[MEASurement<m>:DELay:SLOPe](#) on page 353

Statistics

Activates or deactivates the statistical evaluation for the selected measurement.

Remote command:

[MEASurement<m>:STATistics\[:ENABle\]](#) on page 353

Reset Statistics

Deletes the statistical results for all measurements, and starts a new statistical evaluation if the acquisition is running.

Remote command:

[MEASurement<m>:STATistics:RESet](#) on page 354

Delete all Measurements

Deactivates all active measurements.

Reference Level



Set the lower and upper reference levels for rise and fall time measurements. Sets also the middle reference level used for phase and delay measurements. The levels are defined as percentages of the high signal level. The settings are valid for all measurement places.

Remote command:

[REFLevel:RELative:MODE](#) on page 360

[REFLevel:RELative:LOWer](#) on page 361

[REFLevel:RELative:MIDDLE](#) on page 361

[REFLevel:RELative:UPPer](#) on page 361

7.3 Cursor Measurements

The cursor measurement determines the results at the current cursor positions. You can set the cursor lines manually at fixed positions, or they can follow the waveform. Cursors are available in time and frequency domain. You can measure on one waveform, or on two different waveforms (sources) if the sources are in the same domain (time domain or frequency domain).

If the measured source is an envelope waveform, and you move the cursor slowly, the minimum and maximum values are measured alternating. Zoom and measurement on second source behave in the same way.

Available results depend on the cursor type and the type of the waveform. They are displayed below the grid.

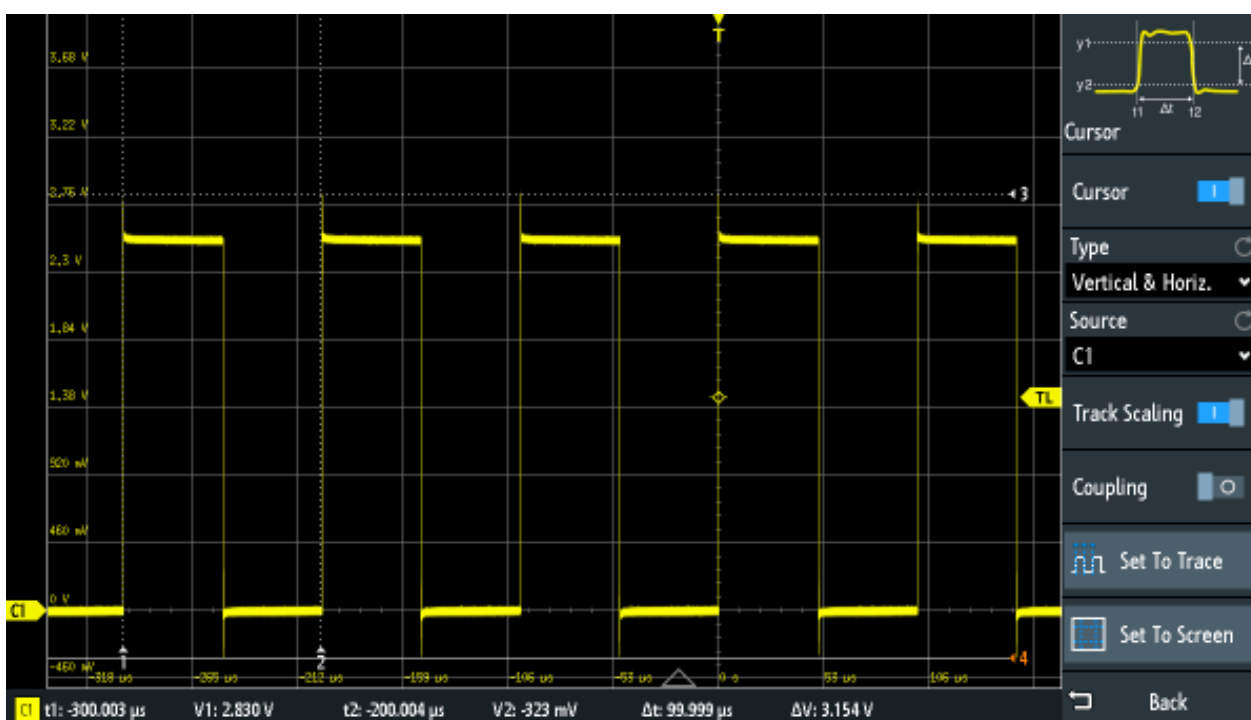

Figure 7-4: Cursor measurement with vertical and horizontal cursors and Set To Trace

Results = below the grid
 Cursor lines 1, 2, 3 = no focus
 Cursor line 4 = has focus, can be moved by turning the [Navigation] knob

To configure cursor measurements

1. Press the [Cursor] key.
The cursors are activated with the latest setting.
2. Press the [Cursor] key again.
The "Cursor" menu opens.
3. Select the cursor "Type".

4. Select the "Source", the waveform you want to measure.
5. Set additional settings if necessary: [Track Scaling](#), [Coupling](#), or [Set To Trace](#).
6. To change the position of a cursor line, you can use several methods:
 - Drag the cursor line on the screen.
 - Press the [Navigation] knob repeatedly until the required cursor line is active (marked with a solid line).
Turn the knob to move the line.
 - Tap the corresponding result value in the result line at the bottom.
The keypad opens, and you can enter an exact value.

7.3.1 Cursor Settings

- ▶ To open the "Cursor" menu:
 - a) Tap the  "Menu" icon in the lower right corner of the screen.
 - b) Scroll down. Select "Cursor".

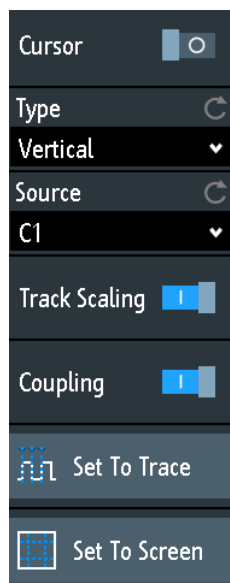

Cursor

Activates or deactivates the cursor measurement.

Remote command:

[CURSor<m>:STATe](#) on page 362

Type

Selects the cursor type. Depending on the type, different results are displayed in the result line at the bottom of the display.

The cursor lines can be set to the required position using the "Navigation" rotary knob, or by dragging a cursor line on the screen.

"Horizontal"	Sets two horizontal cursor lines and measures the voltage values at the cursor positions, and the difference between the cursor lines. Results: V1, V2, ΔV (for current measurements: A1, A2, ΔA , for FFT measurements: L in dBm)
"Vertical"	Sets two vertical cursor lines and measures the time from the trigger point to each cursor line, the time between the cursor lines and the frequency calculated from that time. Results: t1, t2, Δt , $1/\Delta t$ (for FFT measurements: frequencies)
"Vertical & Horiz."	Combines the "Horizontal" cursor and "Vertical" cursor measurements. Two horizontal and two vertical cursor lines are set. The voltages and times are measured at the cursor positions, as well as the delta of the voltage and time values. Results: t1, t2, Δt , V1, V2, ΔV
"V-Marker"	Sets two vertical cursors and measures the values of the waveform at the crossing points of the cursor lines and the waveform. Also, the differences of the two values in x- and y-direction are displayed. Results: t1, V1, t2, V2, Δt , ΔV

Remote command:

[CURSor<m>:FUNctIon](#) on page 362

[CURSor<m>:TRACking\[:STATe\]](#) on page 364 (V-Marker)

Source

Defines the source of the cursor measurement as one of the active waveforms.

You can use cursors on analog input signals, math waveform, reference waveforms, XY-diagram, and FFT waveform.

If option R&S RTB -B1 is installed, you can use the vertical cursor to measure individual logic channels, and the V-Marker to measure pods.

Remote command:

[CURSor<m>:SOURce](#) on page 363

Track Scaling

If enabled, the cursor lines are adjusted when the vertical or horizontal scales are changed. The cursor lines keep their relative position to the waveform.

If disabled, the cursor lines remain on their position on the display if the scaling is changed.

Remote command:

[CURSor<m>:TRACking:SCALe\[:STATe\]](#) on page 365

Coupling

If enabled, the cursors lines are coupled and moved together.

Press the [Navigation] key to select whether both cursors or one cursor is moved. If coupling is disabled, pressing the [Navigation] key toggles the single cursor lines.

Remote command:

[CURSor<m>:XCoupling](#) on page 364

[CURSor<m>:YCoupling](#) on page 364

Set To Trace

Autoset for cursor lines, sets the cursor lines to typical points of the waveform depending on the selected cursor type. For example, for voltage measurement ("Horizontal"), the cursor lines are set to the upper and lower peaks of the waveform. For time measurement ("Vertical"), the cursor lines are set to the edges of two consecutive positive or two consecutive negative pulses.

Remote command:

`CURSor<m>:SWAVe` on page 365

Set To Screen

Resets the cursors to their initial positions. Reset is helpful if the cursors have disappeared from the display or need to be moved for a larger distance.

Remote command:

`CURSor<m>:SSCReen` on page 365

8 Applications

All available applications are provided in the "Apps Selection" dialog.

- ▶ To select an application, press the  [Apps Selection] key.

See also: [Chapter 3.2, "Selecting the Application"](#), on page 26.

Applications are grouped on several tabs:

- Applications, see below
- Protocol
Protocol applications are described in [Chapter 12, "Serial Bus Analysis"](#), on page 188.

On the "Applications" tab, the following applications are available:

- "QuickMeas": see [Chapter 7.1, "Quick Measurements"](#), on page 111
- "Probe Adjust": see [Chapter 4.2, "Adjusting Passive Probes"](#), on page 37
- "Function Gen.": see [Chapter 14.1, "Function Generator"](#), on page 259
- "Pattern Gen.": see [Chapter 14.2, "Pattern Generator"](#), on page 271
- [Mask Testing](#)..... 125
- [FFT Analysis](#)..... 133
- [XY-Diagram](#)..... 140
- [Digital Voltmeter](#)..... 142
- [Trigger Counter](#)..... 144
- [Bode Plot \(Option R&S RTB-K36\)](#)..... 145

8.1 Mask Testing

Masks are used to determine whether the amplitude of a signal remains within specified limits, e.g. to detect errors or test compliance of digital signals.

8.1.1 About Masks and Mask Testing

Masks

A mask is specified by an upper and a lower limit line. The signal must run inside these limit lines, otherwise a mask violation occurs.

A new mask is created from an existing signal: Mask limits are created by copying the envelope waveform, and the limits are moved and stretched. The result is a tolerance tube around the signal that is used as mask.

The mask is displayed in the color used for reference waveforms.

Once a mask has been defined, the copied envelope is kept in the instrument until the next mask is defined or loaded. If you need more than one mask, you can save the mask to internal storage and load it at a later time.

Mask testing results

The mask testing analyzes whether tested signal runs inside the mask. The overall test result is shown in the mask window:

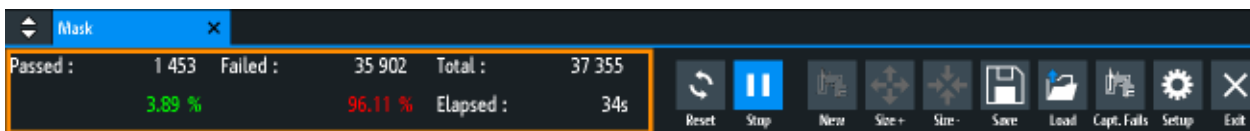

left column = absolute number and percentage of acquisitions that passed the test
middle column = absolute number and percentage of acquisitions that violated the mask
right column = number of tested acquisitions and test duration

During a mask test, various actions can be executed when mask violations occur: notification by a sound, stop of acquisition, saving a screenshot, saving the waveform data, sending a pulse.

Remote commands:

- [MASK:STATe](#) on page 368 to start the mask application
- [MASK:COUNT?](#) on page 372
- [MASK:VCOunt?](#) on page 372

File format for masks: MSK

MSK is the specific binary format for masks of the R&S RTB2000. It contains pairs of amplitude values (in divisions), their sample indexes and current instrument settings. Thus, the amplitude values are not related to time and voltage. The mask data is saved in the internal storage and can be loaded back when needed. The format is not intended for analysis outside the R&S RTB2000.

8.1.2 Using Masks

Starting the mask application

1. Press the [Apps Selection] key.
2. Tap "Mask".

You can also add the mask icon to the toolbar and start the application from the toolbar. See "[Configuring the Toolbar](#)" on page 32.

To create and set up a mask

You create a mask based on a channel waveform, then optimize it by changing its position and proportions, and save it.

1. Select and adjust the channel waveform that you want to use as basis for the mask.
2. Run continuous acquisition.
3. Start the mask application.
4. In the mask window, tap "New".

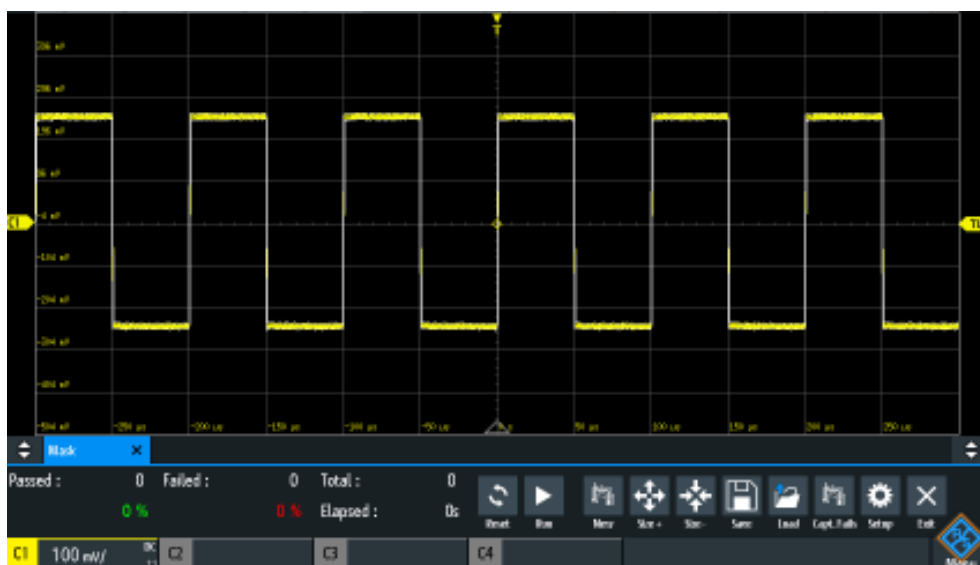

5. Adjust the size of the mask:
 - For simple setup, use "Size+" and "Size-" to change the mask dimensions in x- and y-direction.
 - For detailed setup:
 - Tap "Setup" to open the "Mask" menu.
 - Change "Width Y", "Width X" and/or "Stretch Y".

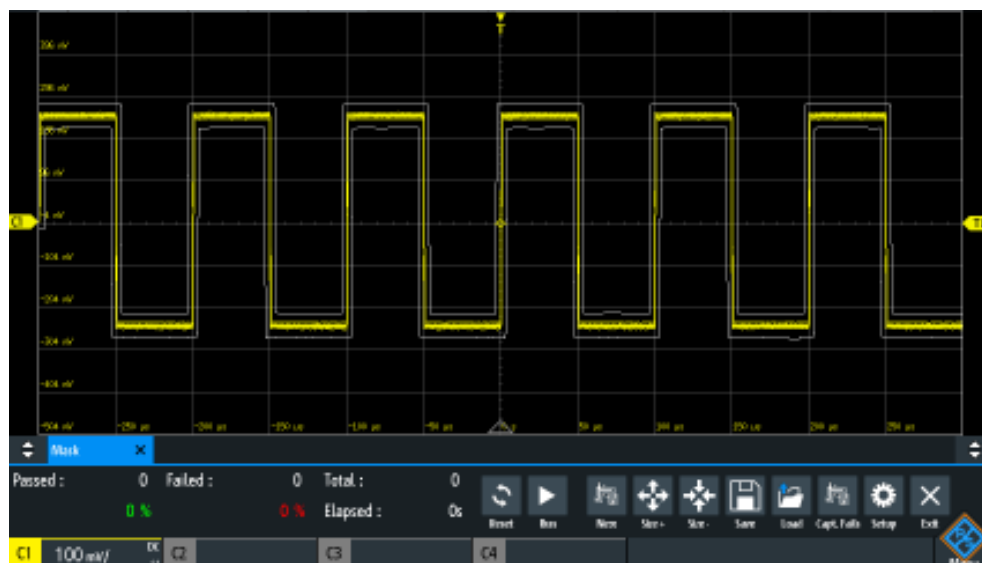

6. To save the mask for later use, tap "Save".

To load a mask

1. Press the  [Apps Selection] key.
2. Tap "Mask".
3. Tap "Load".
4. Select the mask file.
5. Tap "Load".

To perform a mask testing

1. Set up the waveform that you want to test.
2. Create or load a mask. See:
 - ["To create and set up a mask"](#) on page 127
 - ["To load a mask"](#) on page 128
3. If necessary, tap "Setup" and adjust the y-position of the mask.
4. Set the "Actions" to be performed on violation.
5. In the mask window, tap "Run".

If the mask limits are violated, the specified action is taken. The overall result is shown in the mask window.

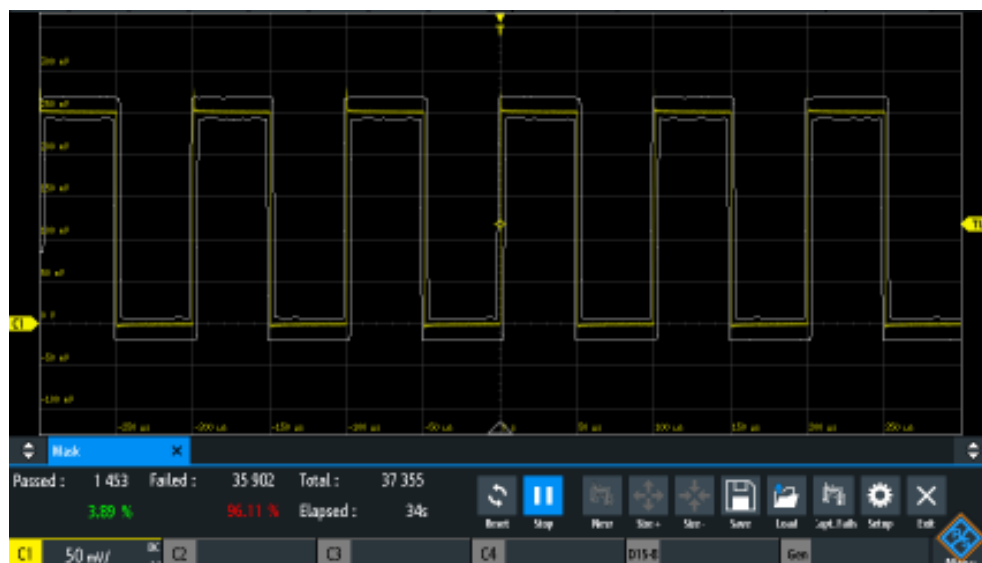

6. Tap "Reset" to delete the results.
7. To finish the test, tap "Stop".

8.1.3 Mask Window

The mask window provides the most important function to set up a mask, and to run the test.



Reset

Deletes all test results.

Remote command:

[MASK:RESet:COUNTer](#) on page 372

Run, Stop

Starts or finishes the mask test.

Remote command:

[MASK:TEST](#) on page 372

New

Creates a mask from the envelope of the selected channel waveform.

Remote command:

[MASK:SOURce](#) on page 368

[MASK:CHCopy](#) on page 368

Size+, Size-

Enlarges or decreases the mask in x- and y-direction.

Save, Load

Saves the created mask to file, or loads a previously saved mask. The file format is MSK.

Remote command:

[MASK:SAVE](#) on page 369

[MASK:LOAD](#) on page 369

Capt. Fails

If selected, only failed acquisitions are saved in memory segments.

Only available with history option R&S RTB-K15.

Remote command:

[MASK:CAPTURE\[:MODE\]](#) on page 372

Setup

Opens the "Setup" menu to define exact mask dimensions and the actions to be executed on violation of the mask.

8.1.4 Mask Menu

- ▶ To open the "Mask" setup menu:
 - Tap the "Setup" button in the mask window.
 - Tap the "Menu" icon. Select "Mask".



Test

Performs a mask test for the selected signal, i.e. the signal amplitudes are compared with the specified mask. If the amplitude exceeds the limits of the mask, a violation is detected.

Remote command:

[MASK:TEST](#) on page 372

Copy Channel

Creates a mask from the envelope waveform of the selected channel and stores it in the instrument.

Remote command:

[MASK:SOURce](#) on page 368

[MASK:CHCopy](#) on page 368

Y-Position

Moves the mask vertically within the display. The current position is given in divisions.

Remote command:

[MASK:YPOStion](#) on page 368

Stretch Y

Changes the vertical scaling to stretch or compress the mask in y-direction.

Remote command:

[MASK:YSCale](#) on page 368

Width X

Changes the width of the mask in horizontal direction. The specified factor in divisions is added to the positive x-values and subtracted from the negative x-values of the mask limits in relation to the mask center. Thus, the left half of the mask is pulled to the left, the right half is pulled to the right.

Remote command:

[MASK: XWIDTH](#) on page 368

Width Y

Changes the width of the mask in vertical direction. The specified number of divisions is added to the y-values of the upper mask limit and subtracted from the y-values of the lower mask limit. Thus, the upper half of the mask is pulled upwards, the lower half is pulled down, and the overall height of the mask is twice the "Width Y".

Remote command:

[MASK: YWIDTH](#) on page 369

Save

Saves the mask in an instrument-specific format (MSK). The complete mask definition - envelope waveform with width, stretch and position settings - is stored.

Remote command:

[MASK: SAVE](#) on page 369 and commands described in [Chapter 15.9.1.5, "Masks"](#), on page 408.

Load Mask

Opens a file explorer to select a previously stored mask. The selected mask is loaded and can be used for a subsequent test.

Remote command:

[MASK: LOAD](#) on page 369

Actions

Opens a submenu to select the actions to be taken when a violation against the mask limits occurs.

"Sound"	Generates a beep sound at each violation.
"Stop"	Stops the waveform acquisition. Set the number of the stop violation. Thus, you can ignore a number of violations before stop.
"Pulse"	Creates a pulse on the [Aux Out] connector. This selection sets the configuration of the [Aux Out] connector to "Mask Violation".
"Screenshot"	Saves a screenshot according to the settings in "File" > "Screenshots".
"Save Waveform"	Saves the waveform data according to the settings in "File" > "Waveforms".

Remote command:

[MASK: ACTION: SOUND: EVENT: MODE](#) on page 369

[MASK: ACTION: STOP: EVENT: MODE](#) on page 369

[MASK: ACTION: STOP: EVENT: COUNT](#) on page 370

[MASK: ACTION: PULSE: EVENT: MODE](#) on page 370

[MASK:ACTion:SCRSave:EVENT:MODE](#) on page 370

[MASK:ACTion:WFMSave:EVENT:MODE](#) on page 370

Capture Segments

Selects whether all acquisitions are stored in segments, or only failed acquisition. You can use the history to analyze the segments.

Only available with history option R&S RTB-K15.

Remote command:

[MASK:CAPTure\[:MODE\]](#) on page 372

8.2 FFT Analysis

The R&S RTB2000 provides basic FFT calculation, which is included in the firmware.

During FFT analysis, a time-based waveform is converted to a spectrum of frequencies. As a result, the magnitude of the determined frequencies is displayed: the power vs. frequency diagram (spectrum). FFT results are useful to obtain an overview of the input signal in the frequency domain and to detect unusual signal effects (such as spurs or distortions) visually.

To enable FFT analysis

- ▶ Press the [FFT] key.
Alternatively, tap the "FFT" icon in the toolbar.

The instrument adjusts the time scale of the waveform and sets appropriate center frequency and span.

To disable FFT analysis

- ▶ There are several ways to exit FFT analysis:
 - Press the [FFT] key repeatedly until FFT is off.
 - Tap the "FFT" icon in the toolbar.
 - In the short menu, tap "FFT Off".

8.2.1 FFT Display

When FFT is active, two diagrams are displayed: the signal vs. time at the top, the result of the FFT analysis at the bottom. Between the diagrams, FFT-specific parameters are shown and can be set directly.



- 1 = Enable FFT
- 2 = Signal vs. time display
- 3 = FFT parameters
- 4 = Spectrum, result of the FFT analysis
- 5 = FFT label with vertical scale (range per division). Color indicates the source waveform of FFT calculation.

Data source

FFT analysis is performed on the data captured from one of the active input channels, or one of the active math or reference waveforms. Analysis can only be performed on one channel at a time.

Timebase

FFT is generally performed on the captured data of a complete acquisition. To reduce calculation time, the instrument automatically sets the time scale and an extract of the original timebase for which the FFT is to be performed. The time gate is indicated by white lines in the time diagram.

Frequency range

The results of the FFT analysis can be restricted to a specified frequency range. Therefore, you define a center frequency and a frequency span, or the start and stop frequencies. Alternatively, you can manually set the resolution bandwidth. When you change the FFT parameters, the time gate on the waveform is adapted automatically.

Vertical position and size of the FFT waveform

To set the position and the vertical scaling, select the FFT window and use the vertical [Scale] and [Offset/Position] knobs.

Remote commands:

- `SPECTrum:FREQuency:SCALE` on page 375
- `SPECTrum:FREQuency:POSition` on page 374

Zoom

You can use the vertical zoom ("Zoom" icon on the toolbar) on the FFT waveform. If you draw the zoom area in the FFT diagram, center, span and vertical scale are adjusted, and the zoomed section of the FFT is displayed in the FFT diagram.

8.2.2 Performing FFT Analysis

1. Press the [FFT] key to start FFT analysis.
2. Press the [FFT] key again to open the FFT menu.
3. Select the "FFT Window" type according to the signal characteristics that are most relevant for your measurement task (see "FFT Window" on page 138).
4. In the "Waveform" menu, select the waveform types you want to display (see "Waveform" on page 139).
5. If you want to adjust the resolution bandwidth manually, disable "Automatic RBW".
6. On top of the FFT window, define the frequency range to be displayed in the spectrum window. The range is defined as $(\text{Center} - \text{Span}/2)$ to $(\text{Center} + \text{Span}/2)$. For details, see [Span](#) and [Center](#).
 - a) Press "Span" to define the width of the frequency range.
 - b) Press "Center" to define the center frequency of the range.
7. To start and stop FFT analysis, press the [Run Stop] key.

8.2.3 FFT Setup

You can set the parameters for the FFT analysis in the spectrum window and in the FFT menu. In addition, the short menu provides frequently used settings.

8.2.3.1 Short Menu for FFT

Frequently used settings are available in the short menu. You can select the waveform type, set full span, open the comprehensive menu and disable the FFT analysis.

- ▶ To open the short menu, tap the FFT label in the bottom line of the display. The label is only available, if the FFT analysis is active.



8.2.3.2 Settings in the FFT Window

Typical FFT parameters can be set directly in the FFT window, above the diagram.



- 1 = Start frequency
- 2 = Stop frequency
- 3 = Center
- 4 = Span
- 5 = Resolution bandwidth (RBW)
- 6 = Width of the timebase extract
- 7 = Position of timebase extract

Start

Defines the start frequency of the FFT waveform. The instrument adjusts the span and the center frequency, and optimizes the timebase extract.

Remote command:

[SPECTrum:FREQUENCY:START](#) on page 376

Stop

Defines the stop frequency of the displayed frequency span. The instrument adjusts the span and the center frequency, and optimizes the timebase extract.

Remote command:

[SPECTrum:FREQUENCY:STOP](#) on page 376

Center

Defines the frequency in the center of the displayed span. The instrument adjusts the start and stop frequencies.

To set the center frequency, you can also use the horizontal [Position] knob if the focus is on the frequency window.

Remote command:

[SPECTrum:FREQuency:CENTer](#) on page 375

Span

The span is specified in Hertz and defines the width of the displayed frequency range, which is $(\text{Center} - \text{Span}/2)$ to $(\text{Center} + \text{Span}/2)$. The instrument adjusts the start and stop frequencies.

To set the frequency span, you can also use the horizontal [Scale] knob if the focus is on the frequency window.

Remote command:

[SPECTrum:FREQuency:SPAN](#) on page 375

RBW

The resolution bandwidth (RBW) determines the resolution of the spectrum, that is: the minimum distance between two distinguishable peaks. The higher the resolution (the smaller the ratio), the more peaks are detected, but the longer the measurement requires to finish.

If "Automatic RBW" is selected, the RBW value is adjusted automatically and the value is shown for information. when you set the RBW manually, the instrument adjusts the timebase extract.

Remote command:

[SPECTrum:FREQuency:BANDwidth\[:RESolution\]\[:VALue\]](#) on page 376

[SPECTrum:FREQuency:BANDwidth\[:RESolution\]:RATio](#) on page 376

W

Shows the width of the timebase extract (gate) for which FFT is calculated.

Remote command:

[SPECTrum:TIME:RANGe](#) on page 377

P

Shows the position of timebase extract (gate) to restrict the timebase of the input signal for which FFT analysis is performed.

Remote command:

[SPECTrum:TIME:POSition](#) on page 376

8.2.3.3 FFT Menu

- ▶ Press the [FFT] key.

If the menu does not open, tap twice: Once to enable FFT, and next to open the menu.



Source

Selects the channel for which the captured data is analyzed with FFT. You can select one of the active input channels, math or reference waveforms.

Remote command:

[SPECTrum: SOURce](#) on page 373

FFT Window

Windowing helps minimize the discontinuities at the end of the measured signal interval and thus reduces the effect of spectral leakage, increasing the frequency resolution.

The R&S RTB2000 provides various window functions to suit different input signals. Each window function has specific characteristics, including some advantages and some trade-offs. Consider these characteristics to find the optimum solution for the measurement task.

- | | |
|------------|-------------------------------------------------------------------------------------------------------------------------------------------------------------------------------------------------------------------------------------------------------------------------------------------------------------------------------------------------------------------------------------------------------------------------------------|
| "Hanning" | The Hanning window is bell shaped. Unlike the Hamming window, its value is zero at the borders of the measuring interval. Thus, the noise level within the spectrum is reduced and the width of the spectral lines enlarges.
Use this window to measure amplitudes of a periodical signal precisely. |
| "Hamming" | The Hamming window is bell shaped. Its value is not zero at the borders of the measuring interval. Thus, the noise level inside the spectrum is higher than Hanning or Blackman, but smaller than the rectangular window. The width of the spectral lines is thinner than the other bell-shaped functions.
Use this window to measure amplitudes of a periodical signal precisely. |
| "Blackman" | The Blackman window is bell shaped and has the steepest fall in its wave shape of all other available functions. Its value is zero at both borders of the measuring interval. In the Blackman window, the amplitudes can be measured very precisely. However, determining the frequency is more difficult.
Use this window to measure signals with single frequencies to detect harmonics and accurate single-tone measurements. |

- "Flat Top" The flat top window has low amplitude measurement errors but a poor frequency resolution. Use this window for accurate single-tone measurements and for measurement of amplitudes of sinusoidal frequency components.
- "Rectangle" The rectangular window multiplies all points by one. The result is a high frequency accuracy with thin spectral lines, but also with increased noise. Use this function for measurements of separation of two tones with almost equal amplitudes and a small frequency distance.

Remote command:

`SPECTrum:FREQuency:WINDow:TYPE` on page 373

Automatic RBW

If enabled, the resolution bandwidth is set automatically. If disabled, you can adjust the "RBW" parameter in the FFT window.

See also: "RBW" on page 137.

Waveform

Selects the waveform type to be displayed. Several types of waveforms can be displayed in parallel, but at least one waveform type must be selected. By default, the "Spectrum" waveform is selected. From each waveform type, you can also create a reference waveform for further analysis, and perform cursor measurements.

When the waveform selection is changed, statistical evaluation is restarted.

To clear the results of previous measurements used for statistical evaluation, select "Reset".



- "Spectrum" The current value for each frequency is displayed.

"Min Hold"	The minimum value for each frequency over all FFTs is displayed. Using the "Min Hold" waveform type is a good way to highlight signals within noise or suppress intermittent signals.
"Max Hold"	The maximum value for each frequency over all FFTs is displayed. Using the "Max Hold" waveform type is a good way to detect intermittent signals or the maximum values of fluctuating signals, for example.
"Average"	The average value for each frequency in the waveform over the specified "# Averages" is calculated. Averaging reduces the effects of noise, but has no effects on sine signals. Therefore, averaging is a good way to detect signals near noise.
"Reset"	Clears the selected waveforms and restarts calculation.

Remote command:

[SPECTrum:WAVEform:SPECTrum\[:ENABLE\] on page 377](#)

[SPECTrum:WAVEform:MINimum\[:ENABLE\] on page 377](#)

[SPECTrum:WAVEform:MAXimum\[:ENABLE\] on page 377](#)

[SPECTrum:WAVEform:AVERage\[:ENABLE\] on page 377](#)

[SPECTrum:FREQuency:AVERage:COUNT on page 377](#)

[SPECTrum:FREQuency:RESet on page 377](#)

Vertical Scale

Defines the scaling unit for the vertical scale.

The displayed values refer to a 50 Ohm terminating resistor. You can use an external terminating resistor parallel to the high impedance input, or the 50 Ohm input directly.

"dBm"	Logarithmic scaling; related to 1 mW
"dBV"	Logarithmic scaling; related to 1 Veff.
"Veff"	Linear scaling; displays the RMS value of the voltage.

Remote command:

[SPECTrum:FREQuency:MAGNitude:SCALE on page 374](#)

8.3 XY-Diagram

XY-diagrams combine the voltage levels of two waveforms in one diagram. They use the amplitude of a second waveform as the x-axis, rather than a timebase. Thus, you can measure phase shift, for example. With harmonically related signals, the resulting XY-diagrams are Lissajous patterns. XY-diagrams can also be used to display the IQ representation of a signal.

Together with the XY-diagram, the time diagrams of the source signals are displayed in separate grids. It is also possible to define two source signals in y-direction for comparison.

1. Press the  [Apps Selection] key.
2. Select "XY".

3. Make sure that the signals, the trigger, and the acquisition are set up correctly. The required menus are available in XY-mode.

Remote command: [DISPlay:MODE](#) on page 388

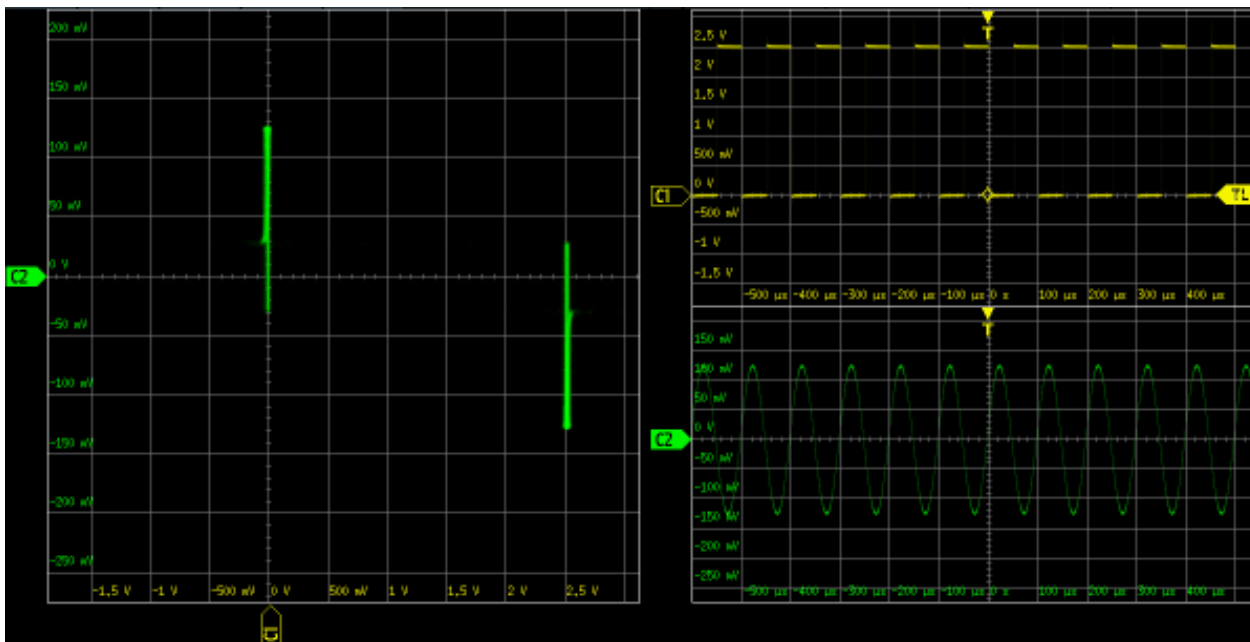

To analyze the signal in the XY-diagram, you can use cursor measurements. You can select specific cursor measurement types: "Voltage X", "Voltage Y1", "Voltage Y2" use 2 cursor lines, "Voltage X-Y1" and "Voltage X-Y2" use 4 cursor lines.



Source X

Defines the source to be displayed in x-direction in an XY-diagram, replacing the usual timebase. The source can be any of the analog channels.

Remote command:

[DISPlay:XY:XSource](#) on page 389

Source Y1

Defines the first signal to be displayed in y-direction in an XY-diagram. The source can be any of the active analog channels.

Remote command:

[DISPlay:XY:Y1Source](#) on page 389

Source Y2

Defines an optional second source to be displayed in y-direction in an XY-diagram. The source can be any of the analog channels. The setting is only relevant for 4-channel R&S RTB2000 instruments.

Remote command:

[DISPlay:XY:Y2Source](#) on page 389

8.4 Digital Voltmeter

The integrated three-digit digital voltmeter simplifies measurements, in particular for service personnel. You can measure up to four parameters on different sources at the same time and define the position of the measurement results.

The following DVM measurements are available:

- DC: mean value of the signal
- AC+DC RMS: RMS value of the signal
- AC RMS: RMS value of the signal's AC component

The digital voltmeter captures input data with the selected vertical sensitivity and the basic accuracy of the ADC. It is independent from the capture settings and the post processing. All measurements are based on a measurement interval, which ensures reliable results over the defined frequency range.

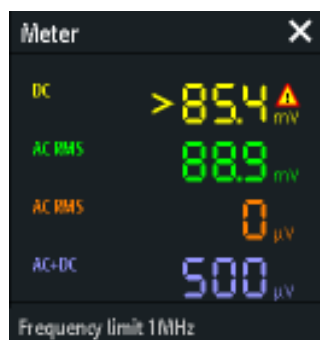

Figure 8-1: Results of 4 meter measurements. The measurement source is indicated by the channel color. The source of meter 1 is channel 1, and it is clipped.

Remote commands to read meter results:

- [DVM<m>:RESult\[:ACTual\]?](#) on page 390
- [DVM<m>:RESult\[:ACTual\]:STATus?](#) on page 391

8.4.1 Using the Meter

To activate meter measurements

- ▶ Use one of the following ways:

- Tap the "Meter" icon on the toolbar.



- Press the [Apps Selection] key. Tap "Meter".

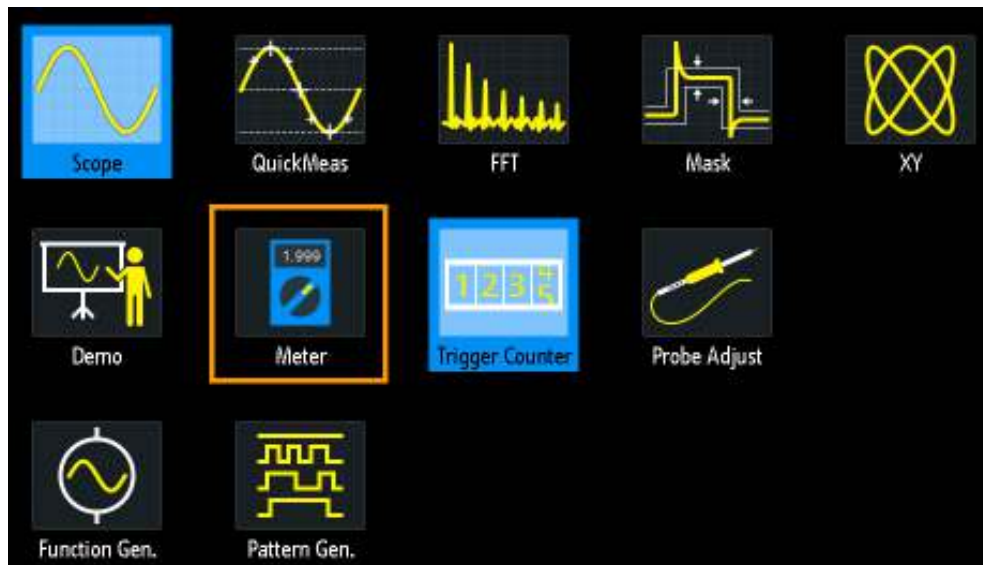

To deactivate meter measurements

- ▶ Use one of the following ways:
 - Tap the "Meter" icon on the toolbar again.
 - Close the "Meter" result box.

8.4.2 Meter Settings

- ▶ To open the "Meter" configuration menu, tap inside the "Meter" result box.



Meter (on/off)

Activates or deactivates the digital voltmeter with the last configuration. Preset deletes the voltmeter configuration.

Remote command:

[DVM<m>:ENABLe](#) on page 389

Meter

Selects one of the four available meter measurements. The configuration of the selected meter is displayed in the menu.

Source

Selects an analog channel as the source of the selected meter measurement.

Remote command:

[DVM<m>:SOURce](#) on page 390

Type

Defines the measurement type to be performed on the selected source:

- DC: mean value of the signal
- AC+DC RMS: RMS value of the signal
- AC RMS: RMS value of the signal's AC component

Select "Off" to disable the selected meter measurement.

Remote command:

[DVM<m>:TYPE](#) on page 390

8.5 Trigger Counter

The counter shows two basic parameters of the trigger source: frequency and period.

1. Press the  [Apps Selection] key.
2. Tap "Trigger Counter".

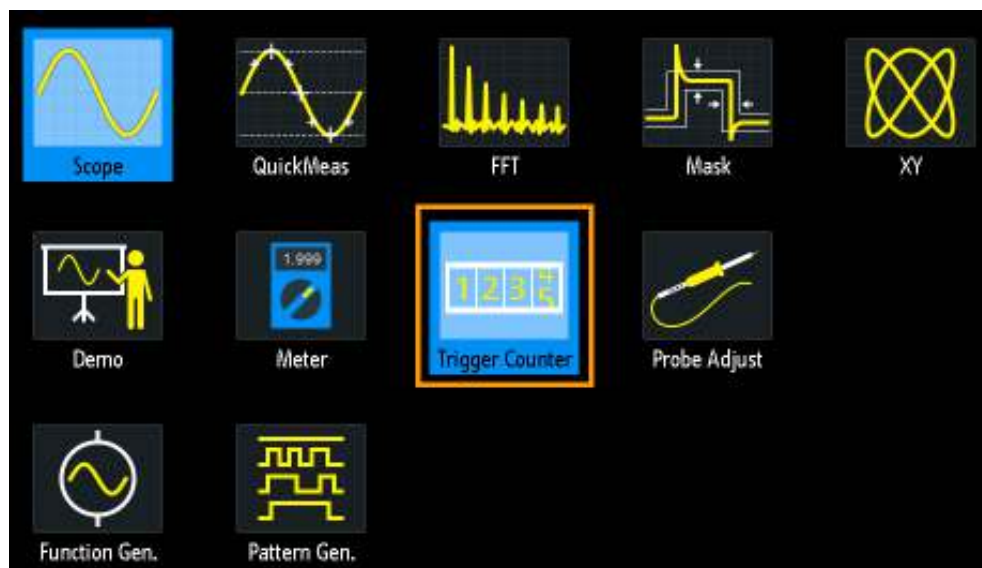

By default, the result box shows the frequency and period of the trigger source.



1. To toggle frequency and period results, tap inside the box.
2. To show the counter results of active waveforms, tap the source icon ("Trg") and select a waveform.
3. To move the result box to the best position, can drag the box on the screen.

Remote commands:

- `TCOUNTER:ENABLE` on page 391
- `TCOUNTER:SOURCE` on page 392
- `TCOUNTER:RESULT[:ACTUAL]:FREQUENCY?` on page 392
- `TCOUNTER:RESULT[:ACTUAL]:PERIOD?` on page 392

8.6 Bode Plot (Option R&S RTB-K36)

A Bode plot displays the frequency response of an electrical system. It is divided in two parts, a magnitude plot and a phase shift plot.

8.6.1 About the Bode Plot

Bode Plot Display

The Bode plot display is divided into several sections, see [fig. 8-2](#).



Figure 8-2: Bode plot display

- 1 = Bode plot parameters
- 2 = Bode plot diagram, gain: blue color; phase: orange color
- 3 = Save
- 4 = Bode result table
- 5 = Marker value table
- 6 = Bode plot window controls
- 7 = Vertical settings of active analog channels
- 8 = Vertical settings of gain waveform
- 9 = Vertical settings of phase waveform

Bode plot diagram

The Bode plot diagram has the frequency presented on the x-axis. The gain (blue color waveform) and phase (orange color waveform) scales are on the y-axis. The magnitude plot represents the gain of a system between input and output. The phase plot shows the phase shift between input and output.

Bode plot result table

In the Bode plot result table, all sample points are displayed with the respective value for the frequency, gain, phase and amplitude. If you select a sample in the table, the respective points in the Bode plot are highlighted by a white line on the gain and the phase curve.

Marker value table

There are two markers available for the Bode plot. They are highlighted on the Bode plot diagram by a white line and the respective marker number 1 or 2. You can move the markers as needed.

In the marker table you can see the frequency, gain and phase values for both of them and also the delta values between the two markers.

Remote commands:

- [BPLot:MARKer<m>:DIFFerence:FREQ?](#) on page 398
- [BPLot:MARKer<m>:DIFFerence:GAIN?](#) on page 398
- [BPLot:MARKer<m>:DIFFerence:PHASe?](#) on page 398
- [BPLot:MARKer<m>:FREQuency](#) on page 399
- [BPLot:MARKer<m>:GAIN?](#) on page 399
- [BPLot:MARKer<m>:INDex](#) on page 399
- [BPLot:MARKer<m>:PHASe?](#) on page 399
- [BPLot:MARKer<m>:SSCReen](#) on page 399

Vertical position and size of the waveforms

To set the position and the vertical scaling of the gain, phase or amplitude waveforms, select the waveform and use the vertical [Scale] and [Offset/Position] (upper knob) knobs.

Remote commands:

- [BPLot:AMPLitude:SCALE](#) on page 397
- [BPLot:AMPLitude:POSition](#) on page 397
- [BPLot:GAIN:SCALE](#) on page 396
- [BPLot:GAIN:POSition](#) on page 396
- [BPLot:PHASe:SCALE?](#) on page 397
- [BPLot:PHASe:POSition?](#) on page 397

8.6.2 Using a Bode Plot

To run a Bode plot measurement

1. Prepare the measurement setup. See "[Connecting the test setup](#)" on page 148
2. Start the Bode plot option. See "[Starting the Bode plot](#)" on page 148
3. Set the required parameters. See "[Setting up the Bode plot](#)" on page 148.

Connecting the test setup

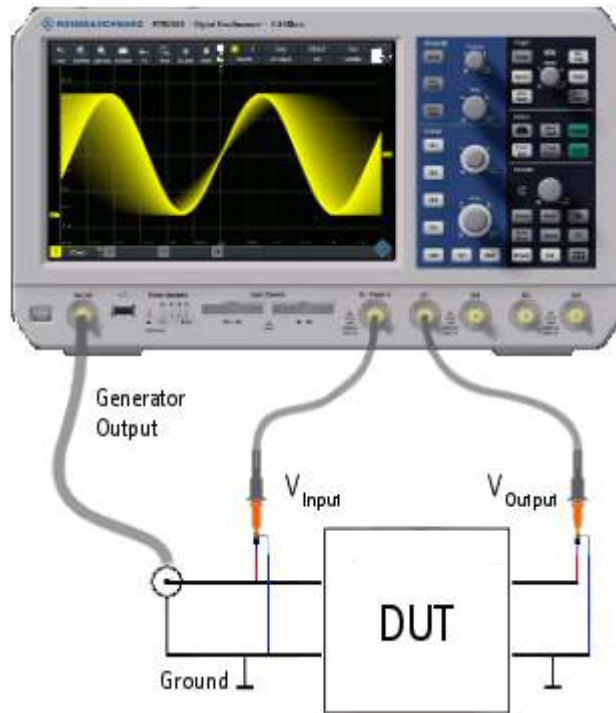



Figure 8-3: Bode Plot Test Setup

1. Connect the DUT input to the generator output of the oscilloscope.
2. Connect the input of your DUT to a channel input of the oscilloscope.
3. Connect the output of your DUT to another channel input of the oscilloscope.
4. Align the probes.



To avoid measurement uncertainties, make sure that the cables connecting the input and the output of your DUT to the oscilloscope are from similar length.

Starting the Bode plot

1. Press the  [Apps Selection] key.
2. Tap "Bode Plot" .
The Bode plot window opens.

Setting up the Bode plot

1. In the Bode window, select the channels for the "Input" and "Output" signal.
2. Set the "Start" and "Stop" frequency for the frequency sweep range.
3. Select the number of "Points" to be shown per decade.

4. Set the amplitude for the measurement.
5. If necessary, open the "Setup" dialog to refine the settings:
 - a) Set an "Amplitude Profile" for systems with sensitive circuits.
 - b) Set the "Maximum Phase" of the system.
 - c) Set a "Meas. Delay" for systems that need more time to adapt to a new frequency.
6. Press "Run" to start the measurement.
7. If necessary, press "Save" to save the measurement results to a file.

8.6.3 Bode Plot Window Controls

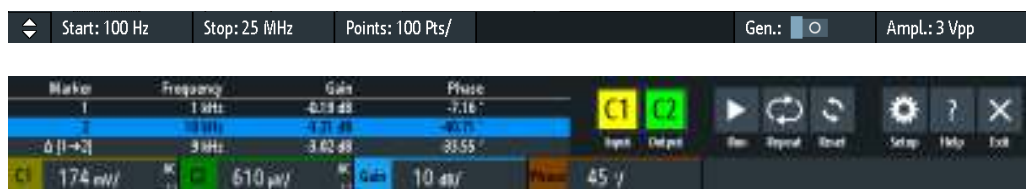

The Bode plot window provides the most important function to set up the plot and to run the test.

Start

Sets the start frequency of the sweep for the Bode plot.

Remote command:

[BPLot:FREQUENCY:START](#) on page 394

Stop

Sets the stop frequency of the sweep for the Bode plot.

Remote command:

[BPLot:FREQUENCY:STOP](#) on page 394

Points

Selects the number of points per decade that are measured from a predefined list. You can also set a different value from the predefined ones in the "Setup" menu.

Gen

Enables the in-built generator. This allows you to start a frequency sweep for a defined frequency range.

Ampl.

Sets a fixed amplitude.

Input

Selects the channel for the input signal of the DUT.

Remote command:

[BPLot:INPut\[:SOURCE\]](#) on page 394

Output

Selects the channel for the output signal of the DUT.

Remote command:

[BPLot:OUTPut\[:SOURce\]](#) on page 395

Gain

Enables the gain waveform for the Bode plot.

Remote command:

[BPLot:GAIN:ENABle](#) on page 396

Phase

Enables the phase waveform for the Bode plot.

Remote command:

[BPLot:PHASe:ENABle?](#) on page 396

Run

Starts the Bode plot measurement.

Remote command:

[BPLot:STATe](#) on page 395

Repeat

Repeats the measurement, using the same parameters.

Remote command:

[BPLot:REPeat](#) on page 395

Reset

Deletes all test results.

Remote command:

[BPLot:RESet](#) on page 395

Setup

Opens the "Setup" menu to define the Bode plot settings.

Save

Saves the created Bode plot to a file. The file format is CSV.

You can find the "Save" icon in the upper right corner of the Bode plot result table, see [Figure 8-2](#).

Remote command:

[BPLot:EXPort:NAME](#) on page 348

[BPLot:EXPort:SAVE](#) on page 348

8.6.4 Bode Plot Settings

- ▶ To open the "Bode Plot" configuration menu, tap "Setup" inside the "Bode Plot" result box.



Amplitude Profile

Enables the amplitude profile. You can then define different amplitudes for different frequency in the "Configuration" dialog. This is useful when testing sensitive circuits, where the amplitude gets too high. In this case distortion might occur.

If this function is enabled, a diagram of the amplitudes for the different frequencies can be displayed on the screen. To do that, press at the bottom of the Bode plot window. You can configure the value curve through the touchscreen.



Remote command:

[BPLot:AMPLitude:MODE](#) on page 393

[BPLot:AMPLitude:ENABLE](#) on page 397

Configuration

Opens a dialog to set the amplitude profile. For each point, you can set an amplitude and frequency pairs.

Remote command:

[BPLot:AMPLitude:PROFile:POINT<n>:AMPLitude](#) on page 393

[BPLot:AMPLitude:PROFile:POINT<n>:FREQuency](#) on page 393

Ampl.

Sets a fixed amplitude.

Points

If the "Amplitude Profile" is enabled, select the number of different points that you can define for the amplitude profile.

Remote command:

[BPLot:AMPLitude:PROFile:COUNT](#) on page 393

Load

Selects the generator voltage display for 50Ω or high impedance load.

Points per Decade

Sets the number of points per decade that are measured.

Remote command:

[BPLot:POINTs:LOGarithmic](#) on page 395

Maximum Phase

Sets the upper boundary of the vertical phase window.

The lower boundary is given by "Maximum Phase" - 360°. By default, the "Maximum Phase" is set to 180° for a phase window ranging from -180° to 180° accordingly.

Display Meas. Points

Enables the display of the measurement points in the bode plot.

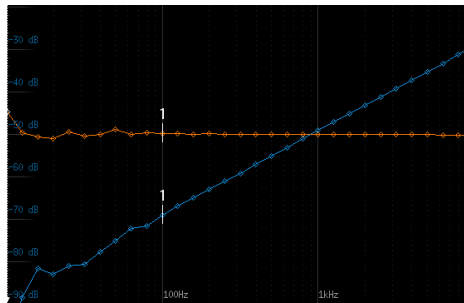

"Display Meas. Points" > On

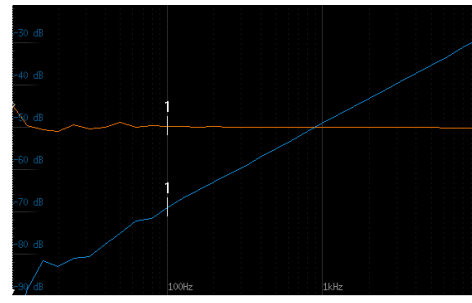

"Display Meas. Points" > Off

Remote command:

[BPLot:MEASurement:POINT\[:DISPLAY\]](#) on page 394

Meas. Delay

Sets a time delay, that the system waits before measuring the next point of the bode plot. This is helpful in systems that need more time to adapt to the new frequency, for example if filters with significant time group delays are present.

Remote command:

[BPLot:MEASurement:DElay](#) on page 394

9 Documenting Results

The R&S RTB2000 can store various data to files for further usage, analysis and reporting:

- Instrument settings: [Chapter 9.1, "Saving and Loading Instrument Settings"](#), on page 155
- Waveforms: [Chapter 9.2, "Saving Waveform Data"](#), on page 156
- Screenshots: [Chapter 9.4, "Screenshots"](#), on page 161
- Reference waveforms
 - [Chapter 6.3, "Reference Waveforms"](#), on page 83
 - Export and import: [Chapter 9.6, "Export and Import"](#), on page 164
- Measurement statistics: [Chapter 7.2.1.1, "Statistics"](#), on page 113
- Equation sets (formularies): [Chapter 6.2.5, "Saving and Loading Formularies"](#), on page 82
- Search results: ["To save search results"](#) on page 98
- Bus table with decode results: ["To save the bus table"](#) on page 193

You can also combine these data and save it to a compressed file using the  key, see [Chapter 9.5, "Quick Save with OneTouch"](#), on page 163

- ▶ To save and load data, press the [Save Load] key.

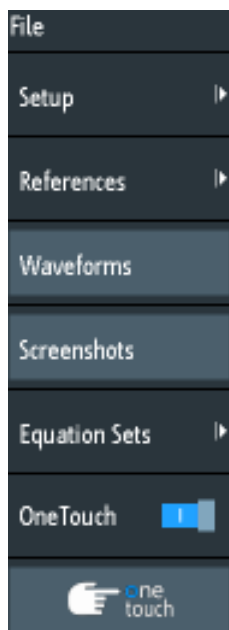

Storage locations

Waveform data, screenshots and results, which are intended for analysis outside the oscilloscope, are always saved to a USB flash drive. The USB flash drive is the exter-

nal storage location (USB_FRONT). This location is only available if the USB flash drive is connected. Using a USB hub is not supported.

Reference waveforms and instrument settings, which are intended for further use on the instrument, are usually saved to the internal storage (/INT). You can also store them to the external storage, or move them to the other location using the export and import function.

The supported file system in all storage locations is FAT.

9.1 Saving and Loading Instrument Settings

To repeat measurements or tests at different times or perform similar measurements with different test data, you can save the used configuration settings. Furthermore, it can be helpful to refer to the configuration settings of a particular measurement when analyzing the results. Therefore, you can easily save the complete measurement configuration including the display settings. The settings are saved together with a small screenshot of the display for better identification of the setup files.

By default, instrument settings are saved to the internal storage /INT/SETTINGS, but you can also save them to USB flash drive.

If you often save and load instrument settings, try the following shortcuts:

- The "Save Setup" toolbar icon saves the current settings to a file according to the settings in "File" menu > "Setup". The "Load Setup" toolbar icon opens a dialog to select and load a setup. See also "[Configuring the Toolbar](#)" on page 32.
- Configure OneTouch to save instrument settings. See [Chapter 9.5, "Quick Save with OneTouch"](#), on page 163.

To save, load, reset, export and import instrument settings

1. Press the [Save Load] key.
2. Select "Setup"
3. Select the required function.

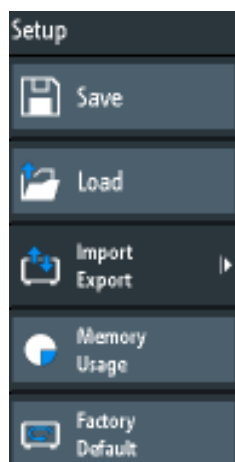

Save

Opens a dialog box to save the current instrument setup to file.

To change the storage location, select "Destination" > "Location".

Change the filename if the auto name does not fit. The file extension SET is set automatically. You can enter an optional comment that describes the setup.

Tap "Save" to start writing the data.

Remote command:

[MMEMory:STORe:STATe](#) on page 420

Load

Opens a file explorer to select an instrument setup file to be loaded to the instrument.

To change the storage location, select "Destination" > "Location".

Tap "Load" to change the settings.

Remote command:

[MMEMory:LOAD:STATe](#) on page 420

Import Export

Opens a menu to copy data between the instrument's internal storage "/INT/SETTINGS" and a USB flash drive.

Make sure that the USB flash drive is connected.

See [Chapter 9.6, "Export and Import"](#), on page 164 for a procedure description.

Memory Usage

Shows free memory space (absolute and relative) in the instrument's internal storage "/INT" and used space per subdirectory in kbyte.

If a USB flash drive is detected, the free memory space in this device is also shown.

Factory Default

Resets the instrument to the factory settings.

Remote command:

[SYSTEM:PRESet](#)

9.2 Saving Waveform Data

Waveform data is always saved to USB flash drive. The waveform export provides the following possibilities:

- Store either one waveform or all active waveforms.
- Option R&S RTB-K15: Save history data.
- Option R&S RTB-B1: Save logic channels.

To save waveforms:

1. Activate the waveforms that you want to export.

2. Press the [Save Load] key.
3. Select "Waveforms".
4. Adjust the settings in the dialog box.
5. Tap "Save".

9.2.1 Waveform Export Settings

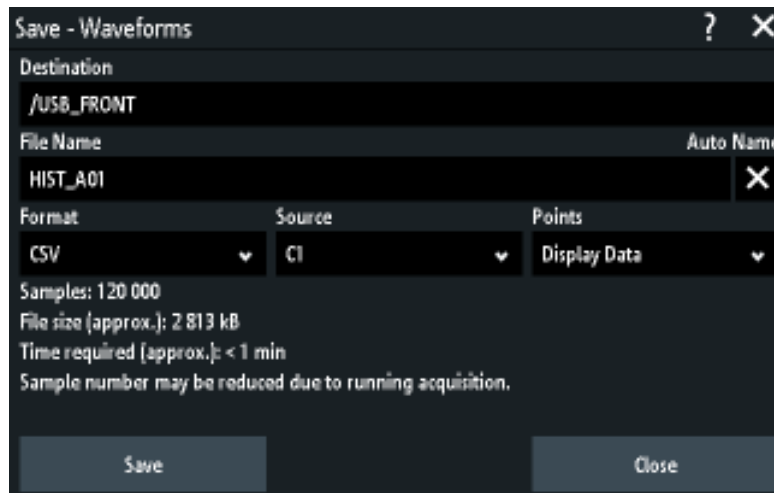

Destination

The destination `/USB_FRONT` is only active, if a USB flash drive is connected to the front USB port.

Tap and select the target folder. Tap "Accept Dir." to confirm selection.

Remote command:

[EXPort:WAVeform:NAME](#) on page 412

File Name

Specifies the name of the file to be saved. The default is `TRACE01` or a higher number, depending on existing files in the target directory.

Remote command:

[EXPort:WAVeform:NAME](#) on page 412

Format

Selects the file format.

- "BIN - MSB": Binary data, most significant byte first
- "BIN - LSB": Binary data, least significant byte first
- "FLT - MSB": Floating point format, most significant byte first
- "FLT - LSB": Floating point format, least significant byte first
- "CSV": Comma-separated values (= default)
- "TXT": Text file format

To reload waveform data as a reference waveform, it must be stored in TRF or CSV format.

For a description of the file formats, see [Chapter 9.2.2, "Waveform File Formats"](#), on page 158.

Source

Select the channels to be saved: either one active channel, or all active channels together.

Remote command:

`EXPort:WAVeform:SOURce` on page 412

Points

Selects the number of data points to be saved in the waveform file.

- "Display Data": Saves all currently displayed waveform samples.
- "Acq. Memory": Saves all data samples that are stored in the acquisition memory. This setting takes effect only for stopped acquisitions. For running acquisitions, only always display data can be saved.
- "History Data": Saves the waveform data of the history segments. See also [Chapter 6.4.5, "Exporting History Data"](#), on page 93.

Remote command:

`CHANnel<m>:DATA:POINTs` on page 403

Save

Saves the data to the selected storage directory. The used path and filename are displayed when the storage is completed.

Saving is not possible if "Points" is set to "Acq. Memory" or "History Data" and the acquisition is running.

Remote command:

`EXPort:WAVeform:SAVE` on page 412

9.2.2 Waveform File Formats

Data of all waveforms is saved as a succession of values or pairs of values. Pairs of values are written as two consecutive single values. Depending on the file format, only amplitude values are stored, or the amplitude values are stored together with their time value, or frequency value in FFT mode.

With export/import, you can change the target file format and convert the data.



To reload waveform data as a reference waveform, it must be stored in TRF or CSV format.

9.2.2.1 CSV Format

In a Comma Separated Values text file, the waveform is stored in a two-columned table. Columns are separated by a comma, and the lines are separated by line breaks `\r\n` (0x0D 0x0A). Values are listed in scientific notation.

The first column contains the time values of the samples in relation to the trigger point, and the second column contains the associated amplitude values. The first line indicates the units of the values in each column, and the name of the waveform. Pairs of values are listed as two single values with the same time value (minimum and maximum).

The data can be loaded back to the instrument for further use.

Example CSV1: Waveform of channel 1, single values

```
in s,CH1 in V
-1.1996E-02,1.000E-02
-1.1992E-02,1.000E-02
-1.1988E-02,1.000E-02
-1.1984E-02,1.000E-02
```

Example CSV2: Waveform of channel 1, pairs of values

```
in s,CH1 in V
-2.9980E+00,2.000E-05
-2.9980E+00,1.400E-04
-2.9960E+00,-1.800E-04
-2.9960E+00,1.400E-04
-2.9940E+00,-1.800E-04
-2.9940E+00,1.400E-04
```

Example CSV3: FFT

```
in Hz,FFT in dBm
0.000000E+00,1.03746E+01
1.525879E+02,7.49460E+00
3.051758E+02,-1.19854E+01
4.577637E+02,-1.56854E+01
```

Import of CSV files: If you import a CSV file as reference waveform from a USB flash drive to the instrument, the import converts the data to TRF format. The instrument reads the first and the last time value and calculates the total time of the waveform, and it counts the number of values. Then all amplitude values are read one by one and written with an equidistant time distribution to the TRF file. If the first two time values are identical, the waveform is considered to consist of pairs of values.

9.2.2.2 TXT Format

TXT files are ASCII files that contain only amplitude values but no time values. Amplitude values are separated by commas. Pairs of values are listed as two subsequent single values, without any identification. Amplitude values are given in scientific notation. There is no comma at the end of the file.

Amplitude values are given in scientific notation.

Example: TXT file

```
1.000E-02,1.000E-02,1.000E-02,1.000E-02,3.000E-02
```

9.2.2.3 BIN Format

BIN files contain only binary amplitude values but no time values. Each value has a word size of 8, or 16, or 32 bit, the word size is the same throughout the file.

You can set the word order: BIN MSBF saves data in Big Endian order - beginning with the MSB (Most Significant Byte) and ending with the LSB (Least Significant Byte). BIN LSBF saves data beginning with the LSB and ending with the MSB. Pairs of values are listed as two subsequent single values, without any identification.

9.2.2.4 FLT Format

FLT files contain amplitude values in float format, where a 32-bit float value is saved in 4 successive bytes.

You can set the word order: FLT MSBF saves data in big endian order - beginning with the MSB (most significant byte) and ending with the LSB (least significant byte). FLT LSBF saves data beginning with the LSB and ending with the MSB.

9.2.2.5 TRF Format

TRF is the specific binary format for reference waveforms of the R&S RTB2000. It contains the amplitude value of each sample that is displayed on the screen (8 bit or 16 bit long). For peak-detect waveforms, 2 values per sample are saved. The file contains also time information (time of the first sample and the sample interval) and current instrument settings.

The data can be loaded as reference waveform for further use on the instrument. It is not intended for analysis outside the R&S RTB2000.

9.3 Annotations

Using the annotation tool, you can mark important places in the diagram and add text. Then you can save the annotated diagram in a screenshot.

To create annotations

1. Tap the "Annotation" icon in the toolbar.
2. Use the annotation tools to draw and write on the screen.

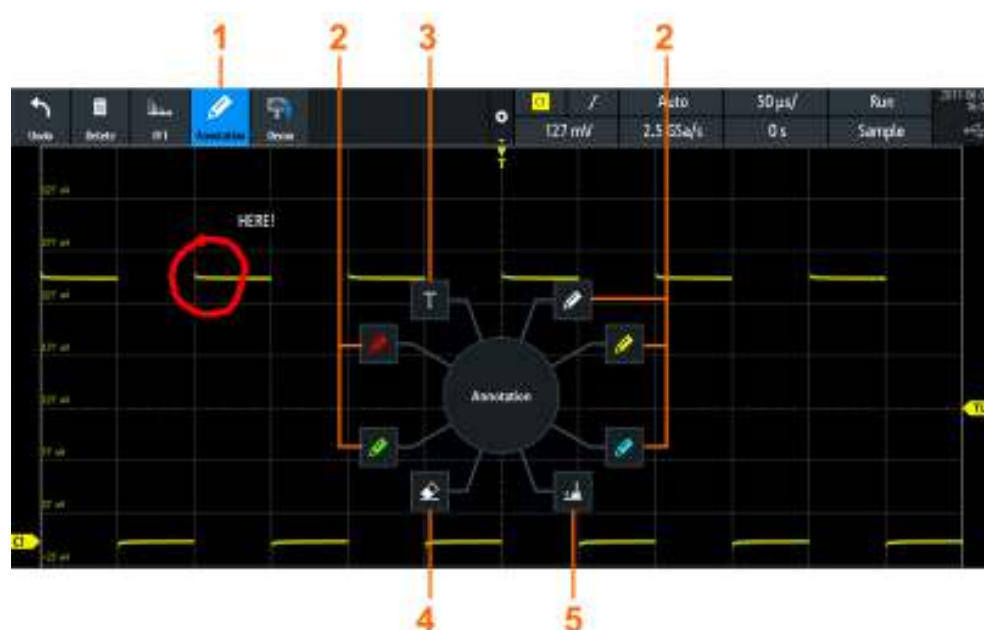

- 1 = Annotations on / off
- 2 = Drawing tools
- 3 = Text tool
- 4 = Eraser to delete single lines
- 5 = Remover to delete all annotations

3. To finish, tap the "Annotation" icon in the toolbar.
To change the tool, switch the "Annotation" tool off and on again.

9.4 Screenshots

You can create and save screenshots of the current display of your waveforms and measurement results. The R&S RTB2000 saves screenshots to USB flash drive. To save screenshots quickly, you can use the "Screenshot" toolbar icon or the [Camera] key.



You can configure the [Camera] key to save screenshots by a single keypress. See also [Chapter 9.5, "Quick Save with OneTouch"](#), on page 163.



The "Screenshot" toolbar icon saves the current display to a file according to the settings in "File" menu > "Screenshots". See also ["Configuring the Toolbar"](#) on page 32.

To save screenshots:

1. Press the [Save Load] key.
2. Disable "OneTouch"
3. Press the  key each time when you want to save a screenshot.
Alternatively, tap the "Screenshot" toolbar icon. To see the icon, add it to the toolbar.

To configure screenshots:

1. Press the [Save Load] key.
2. Select "Screenshots".
3. Adjust the target directory ("Destination"), filename, format, and color mode.

You can save the current display with "Save", or close the dialog box. The screenshot settings are saved and applied when you create screenshots with the  key.

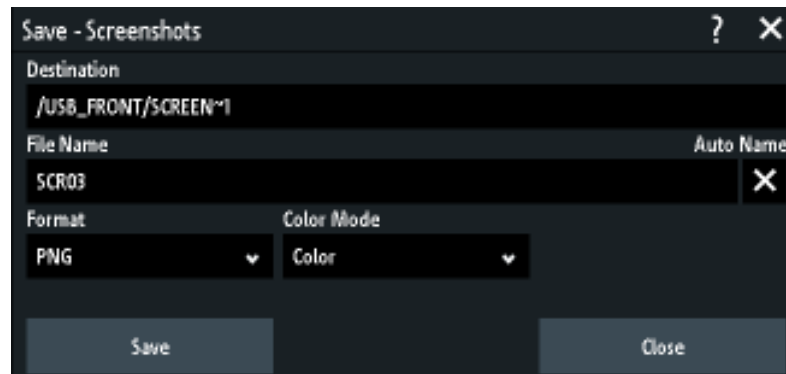

Destination

The destination `/USB_FRONT` is only active, if a USB flash drive is connected to the front USB port.

Tap and select the target folder. Tap "Accept Dir." to confirm selection.

Remote command:

[MMEemory:CDIRectory](#) on page 416

File Name

Specifies the name of the file to be saved. The default is `SCR01` or a higher number, depending on existing files in the target directory.

Remote command:

[MMEemory:NAME](#) on page 413

Format

Selects the file format.

- "BMP": Bitmap is an uncompressed format, files are large and saving can take some time.
- "PNG": Portable Network Graphics is a graphic format with lossless data compression.

Remote command:

[HCOPY:FORMat](#) on page 414

Color Mode

Selects the color settings for the screenshot to be saved.

- "Grayscale": Converts the display colors to a monochrome image
- "Color": Keeps the original display colors in the screenshot.

- "Inverted": Inverts the colors of the output, so that a dark waveform is printed on a white background.
- "Inverted (gray)": Inverts the colors of the output, and converts to a monochrome image.

Remote command:

`HCOPY:COLor:SCHEME` on page 414

Save

Saves the screenshot to the specified file. The used path and filename are displayed when the storage is completed.

Remote command:

`HCOPY[:IMMEDIATE]` on page 413

9.5 Quick Save with OneTouch

The  key initiates one or more assigned saving actions. By default, the key saves a screenshot.

If OneTouch is enabled, you can assign the following actions to the  key:

- Save instrument settings.
- Save a screenshot using the settings in [Save Load] > "Screenshots".
- Save waveforms using the settings in [Save Load] > "Waveforms". If "History Data" is selected under "Points", this setting is ignored, and the acquired data of the newest segment is saved.
- Save reference waveforms.
- Save search results.
- Decoded bus data ("Bus Table", requires at least one protocol option for serial bus).
- Statistical results. OneTouch is the only way to save statistical results.

All data is saved to a ZIP file on the connected USB flash drive.

To configure and use OneTouch:

1. Connect the USB flash drive.
2. Press the [Save Load] key.
3. Enable "OneTouch".
4. Tap "onetouch".
5. Select the target directory ("Destination"), filename, and data you want to save.



6. To save the data now, tap "Save".
7. Close the dialog.
8. Press the  key each time when you want to save the data.

9.6 Export and Import

To copy reference waveforms, formularies (equation sets), and instrument settings from the internal storage to USB flash drive or vice versa, the "Import Export" functions are used.

The name of the target file can be changed, so you can copy and rename in one operation. For reference waveforms, you can also change the target file format and convert the data during export/import.

1. Connect the USB flash drive.
2. Press the [Save Load] key.
3. To copy setup files, select "Setup" > "Import Export".
To copy reference waveforms, select "References".

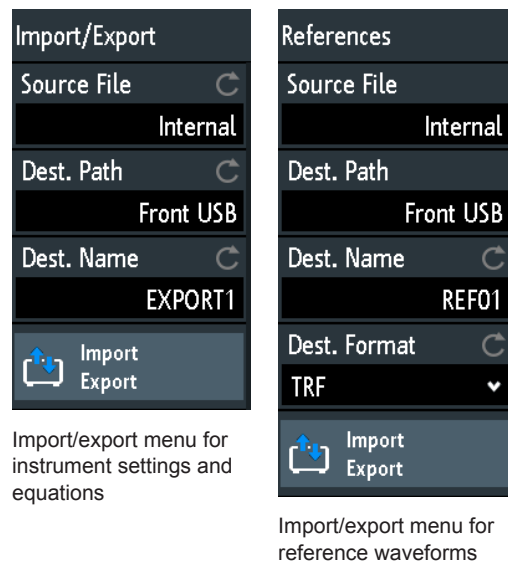

4. Define the source file for the copy operation:
 - a) Tap "Source File".
 - b) If necessary, change the storage location with "Location".
 - c) Select the folder that contains the source file.
 - d) Select the file. A small screenshot helps to identify the file.
 - e) Tap "Load".

The source file is selected, but not loaded to the R&S RTB2000.

5. Define the target directory.
 - a) Tap "Dest. Path".
 - b) If necessary, change the storage location with "Location".
 - c) Select the target folder. You can also create a folder here.
 - d) Tap "Accept Dir."
6. If necessary, change the name of the target file in "Dest. Name".

Note: If a file with the same filename already exists in the destination directory, it will be overwritten without notification.

7. For reference waveforms, you can change the file format in "Dest. Format".
8. Tap "Import Export".

The source file is copied to the destination directory with the specified name and format.

10 General Instrument Setup

The general instrument settings are available in all operating modes.

10.1 Instrument Settings



► To open the "Setup" menu:

- a) Tap the "Menu" rhomb icon in the lower right corner of the screen.



- b) Scroll down. Select "Setup".



Device Information

Displays information on the instrument, such as its serial number, the installed firmware version and hardware information. This information is required if you have a support request. The dialog also contains a link to the "Open Source Acknowledgment".

Language

See [Chapter 10.6, "Setting the Data, Time and Language"](#), on page 174.

Self Alignment

See [Chapter 10.5, "Performing a Self-Alignment"](#), on page 173.

Probe Adjust

Opens the wizard for probe compensation. You can find this function also when you press the [Apps Selection] key.

See: [Chapter 4.2, "Adjusting Passive Probes"](#), on page 37.

Interface

Activates or deactivates additional instrument interfaces. Use these interfaces to communicate with the instrument, for example to read out data or automate the measuring station. USB and Ethernet (LAN) interfaces are installed in the rear panel. After selecting an interface, tap "Parameter" to define additional parameters.



USB ← Interface

Activates the type B USB interface on the rear panel for remote control. This USB interface provides a simple way to connect the instrument to a PC. The USB 2.0 standard is supported. Use a connection cable that is suitable for a type B USB interface.

See also: [Chapter 11.2, "USB Connection"](#), on page 181.

Ethernet ← Interface

Activates the Ethernet interface on the rear panel, which allows connecting the instrument to various other devices. Access to the instrument is controlled via its IP address.

By default, the instrument is set to use DHCP. If the instrument cannot find a DHCP server, it takes about two minutes until the Ethernet parameters are available.

See also: [Chapter 11.1, "LAN Connection"](#), on page 178.

Parameter ← Interface

Opens a dialog to configure Ethernet parameters, or to select the USB connection depending on the selected interface.

Aux Out

Opens the "Aux Out" menu to define which signals are generated at the [Aux Out] connector.

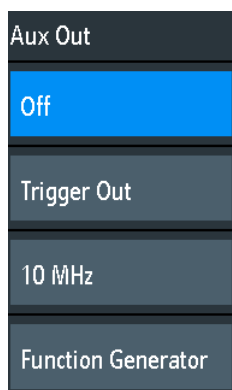

"Off" Disables the auxiliary output.

- "Trigger Out" Outputs a pulse when the instrument triggers.
- "10 MHz" Outputs a 10 MHz reference frequency.
- "Function Generator"
Outputs the waveform specified in the "Function Generator" dialog.
- "Mask Violation"
Outputs a pulse when a mask is violated.
This setting is only available if the "Mask" application is selected in the "Apps Selection" dialog.

Remote command:

TRIGger:OUT:MODE on page 432

Firmware Update

See [Chapter 10.8, "Updating the Firmware"](#), on page 176.

Options

See [Chapter 10.7, "Options"](#), on page 175.

Date & Time

See [Chapter 10.6, "Setting the Data, Time and Language"](#), on page 174.

Education Mode

Disables several functions for educational purposes or enables these functions for normal usage.

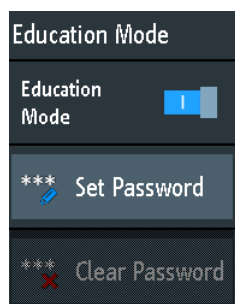

"Education Mode"

If enabled, the autoset, quick measurement and automatic measurement are disabled and not available. The active education mode is indicated in the upper right corner by a doctoral cap icon.



"Set Password"

You can enter a password to prevent unauthorized activation or deactivation of the education mode.

"Clear Password"

Deletes the password and allows all users enabling or disabling the education mode. You have to enter the password first before you can delete it.

Using the remote command, you can clear the education mode password without using the password.

Remote command:

`SYSTem:EDUCation:PRESet` on page 429

Secure Erase

Deletes current instrument configuration data and user data from the internal storage (for example, reference files, equation sets, masks). Calibration data remains in the storage.

Use this function before you send the instrument to the service. If the instrument is used in a secured environment, the function ensures that all sensitive data is removed before the instrument leaves the secured area.

Unintended "Secure Erase" is prevented by a notification that explains what happens if you proceed. To start "Secure Erase", select "Yes", otherwise select "No". Do not turn off the instrument before the erasing process has been completed.

10.2 Display Settings

- ▶ To delete all waveforms and measurement results from the display, press the [Clear Screen] key.

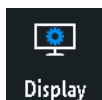

- ▶ To open the "Display" menu:
 - a) Tap the "Menu" icon in the lower right corner of the screen.
 - b) Scroll down. Select "Display".

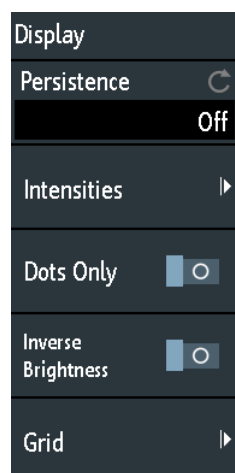

- ▶ To remove all waveforms and results from the display, press the [Clear Screen] key at the front panel.

Persistence

Defines the persistence (afterglow effect) of the waveform on the display.

"Off"	Deactivates persistence.
"Manual"	User-defined persistence according to "Time" setting.
"Infinite"	Activates persistence with infinite duration. Each new data point remains on the screen infinitely until this setting is changed or the persistence is cleared

Remote command:

[DISPlay:PERStence:TYPE](#) on page 422

Time ← Persistence

Specifies the afterglow duration if "Persistence" is set to "Manual". Each new data point remains on the screen for the time defined here. Values range from 50 ms (= default) to 12.8 s.

Remote command:

[DISPlay:PERStence:TIME](#) on page 422

Intensities

Provides functions to define the brightness (relative luminous intensity) of display elements and control LEDs.

You can also open this menu directly using the [Intensity] key.

Intensities	
Waveform	50 %
Grid	50 %
LED Brightness	75 %

Waveform ← Intensities

Defines the brightness of the waveform lines in the diagram. Enter a percentage between 0 (barely visible) and 100% or turn the [Navigation] knob to adjust the waveform brightness directly. The default value is 50%.

Remote command:

[DISPlay:INTensity:WAVeform](#) on page 424

Grid ← Intensities

Defines the brightness of the grid lines in the diagram. Enter a percentage between 0 (barely visible) and 100% or turn the [Navigation] knob to adjust the grid brightness directly. The default value is 50%.

Remote command:

`DISPlay:INTensity:GRID` on page 424

LED Brightness ← Intensities

Defines the intensity of illuminated front panel keys and rotary knobs in percent.

Remote command:

`DISPlay:INTensity:BACKlight` on page 424

Dots Only

If activated, only the individual data points are displayed. If deactivated, the individual data points are connected by a line.

Remote command:

`DISPlay:STYLE` on page 425

Inverse Brightness

Inverts the brightness level of the signals. Normally, values that occur frequently are brighter than rare values. This setting inverts this behavior: Rare values are brighter than frequent values. Use this setting in combination with persistence to detect rare values within the waveform.

Remote command:

`DISPlay:PALETTE` on page 425

Grid

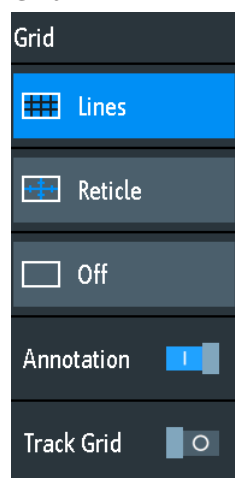

Defines how the grid is displayed.

"Lines" Displays the grid as horizontal and vertical lines.

"Reticle" Displays crosshairs instead of a grid.

"Off" Removes the grid from the display.

Remote command:

`DISPlay:GRID:STYLE` on page 424

Annotation ← Grid

Enables or disables the display of scale values and units for the x-axis and y-axis at the grid lines. Per default, grid labels are enabled.

Remote command:

`DISPlay:GRID:ANNotation[:ENABle]` on page 425

Track Grid ← Grid

If enabled, the grid moves with the waveforms if you change the waveform's position in horizontal or vertical direction.

If disabled (= default), the grid remains centered on the display if you change the waveform's position.

Remote command:

`DISPlay:GRID:ANNotation:TRACk` on page 425

10.3 Reset

Reset is helpful if the instrument is in undefined condition and cannot be operated.

To reset all waveform and measurement settings:

- ▶ Press [Preset].

Preset does not change the display settings, for example, intensities and brightness.

To reset these settings, restore the factory settings.

To restore the factory settings:

1. Press [Save Load].
2. Tap "Setup".
3. Tap "Factory Default".

If it is not possible to reset the instrument using the keys and the touchscreen, proceed as follows:

1. Shut down the instrument: press the [Standby] key.
2. Start the instrument: press the [Standby] key.
3. As soon as the message "Press Autoreset to restore English language" is shown on the start screen: Press and hold the Preset key until the "Update firmware" dialog is shown.
4. Tap "Exit" to close the dialog box.

All instrument settings are reset to factory defaults, and you can use the instrument as usual.

10.4 Locking the Touchscreen

The Touch Lock key locks the touchscreen to prevent unintended use. When the touchscreen is off, the key is illuminated. Press again to unlock the touchscreen.

10.5 Performing a Self-Alignment

The self-alignment aligns the data from several input channels vertically and horizontally to synchronize the timebases, amplitudes and positions.

Recommendation on performing the self-alignment:

- When putting the instrument into operation for the first time
- After a firmware update
- Once a week
- When major temperature changes occur (> 5°)

NOTICE

Preparing the instrument for self-alignment

Make sure that the instrument has been running and warming up before you start the self-alignment. The minimum warm-up time is indicated in the data sheet.

Before the self-alignment, remove all probes, leads, and other connected lines from the instrument input.

1. Remove all probes, leads, and other connected lines from the instrument inputs.
2. Open the "Setup" menu.
3. Tap "Self Alignment"
4. Tap "Start".

The alignment can take up to 15 minutes. You can stop the process with "Abort".

5. When finished, tap "OK" to close the message box.
6. Tap "Exit".

Description of settings

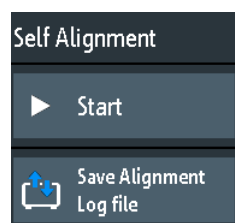

Start

Starts the internal self-calibration of the instrument. Status information is displayed on the screen.

Remote command:

[CALibration](#) on page 426

Save Alignment Log file

The log file records the results of the self-alignment. You save the log file.

Remote command:

[CALibration:STATE?](#) on page 426

10.6 Setting the Data, Time and Language

The instrument has a date and time clock. You can adjust the clock to the local time, and you can select the display language. Supported languages are listed in the data sheet. The help is provided in English. A reboot of the instrument is not necessary.

To set date and time

1. Open the "Setup" menu.
2. Scroll down the menu. Tap "Date & Time".
3. Select the date: Scroll the year, month, and day columns until the required date is displayed.
4. Select the time: Scroll the hour and minute columns until the required time is displayed.

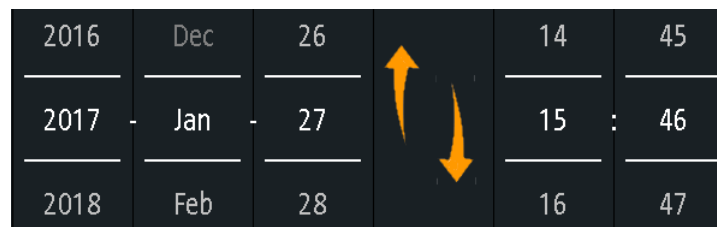

5. Tap "Save".

To set the language

1. Open the "Setup" menu.
2. Tap "Language".
3. Select the language.
The language is changed immediately.

Description of settings

Language

Selects the language in which the button labels and other screen information is displayed. The help is available only in English.

Remote command:

`DISPlay:LANGuage` on page 421

Date & Time

Provides a dialog to set the current date and time in the instrument.

Remote command:

`SYSTem:DATE` on page 427

`SYSTem:TIME` on page 427

10.7 Options

All options are activated by license keys. No additional installation or hardware change is required.



Unregistered licenses

Unregistered licenses are not assigned to a particular instrument. The instrument accepts only registered licenses. If your license is delivered unregistered, use the online tool R&S License Manager to register the license for your instrument. The registration of a permanent license is irreversible, so ensure that you register it for the correct instrument. The address of the tool is <https://extranet.rohde-schwarz.com/service>.

The "Active Options" tab provides information on installed software options. Here you can install new options or deactivate existing options using license keys.

The "Inactive Options" tab lists all deactivated and expired options.

The "Deactivated Options" tab shows all deactivated options with their deactivation information and provides a function to export the deactivation response. The response is required by the R&S License Manager.

10.7.1 Activating Options

Consult your sales representative and provide the material number, serial number, and the device ID of your instrument to get a license key. You find this information in "Setup" menu > "Device Information".

The license key is provided in written form or in a file. Unregistered licenses must be registered in the R&S License Manager before they can be activated on the instrument.

1. If you received the option key in a file, save the file to a USB flash drive.

2. Connect the drive to the R&S RTB2000.
3. Tap the "Menu" icon in the lower right corner of the screen.



4. Scroll down the menu. Tap "Setup".
5. Select "Options".
6. If you received a key in written form, tap "Input option key manually". Enter the key. If you received a key in digital form as a file, tap "Read option key from file". Select path /USB_FRONT and the option key file.

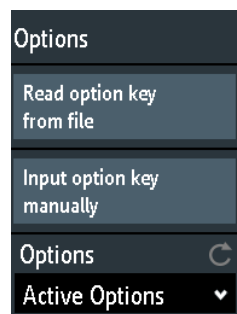

7. If you want to activate several options, repeat step 5 for each option.
8. Restart the instrument.

10.8 Updating the Firmware

Your instrument is delivered with the latest firmware version. Firmware updates are provided on the Internet at

www.rohde-schwarz.com/firmware/rtb2000.

Along with the firmware file, you find the Release Notes describing the improvements and modifications.

Make sure to update the firmware if a new version is available.

1. Download the firmware installation file *.fwu to a USB flash drive.
2. Connect the USB flash drive to the USB connector at the front of the instrument.
3. Tap the "Menu" icon in the lower right corner of the screen.



4. Scroll down the menu. Tap "Setup".
5. Select "Firmware Update"

Now you can see an info window with information about the installed and new firmware and front controller firmware. If you have no newer firmware than the installed one, a message appears.

6. Tap "Execute" to start the firmware update.

Wait until the update has finished. After installation, the instrument restarts automatically.

11 Network Connections and Remote Operation

11.1 LAN Connection

The R&S RTB2000 is equipped with a network interface and can be connected to an Ethernet LAN (local area network). A LAN connection is necessary for remote control of the instrument, and for access from a computer using a web browser.

Connecting the instrument to the LAN

1. Connect the LAN cable to the LAN connector at the rear panel of the instrument.
2. Open the "Setup" menu.
3. Tap "Interface".



If the menu items are grayed, the connection failed. Check the connection of the LAN cable and the network availability.

4. Tap "Ethernet" to select LAN connection.
5. Tap "Parameter".

You see all connection details on the display, and you can save them to a file.

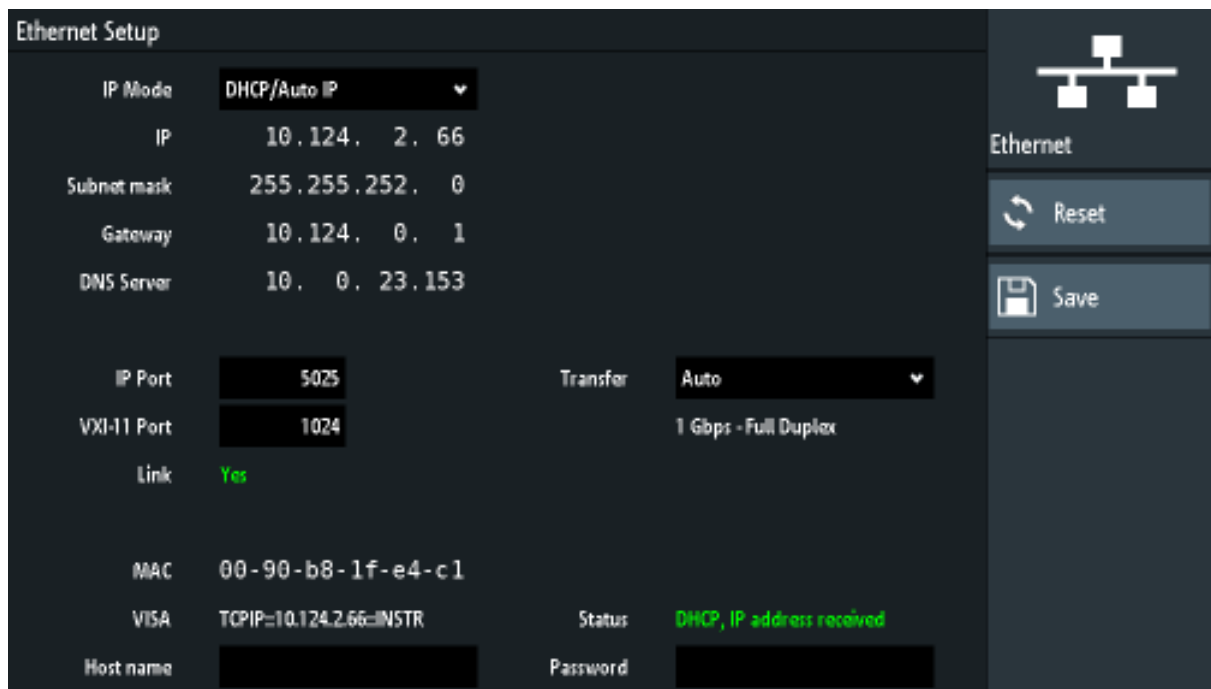

Figure 11-1: Example of the Ethernet setup dialog and menu

Description of settings

IP Mode

Selects the Internet protocol mode:

- "Manual": To be used if the network does not support dynamic host configuration protocol (DHCP). The addresses must be set manually.
- "DHCP/Auto IP" enables DHCP for automatic network parameter distribution and shows the values of these parameters. By default, the instrument is configured to use dynamic configuration and obtain all address information automatically. Thus, it is safe to establish a physical connection to the LAN without any previous instrument configuration.

Note that refreshing the values (for example after disconnecting the LAN cable and reconnecting it) may take a while, depending on the network responsiveness.

Remote command:

[SYSTem:COMMunicate:INTerface:ETHernet:DHCP](#) on page 430

IP, Subnet mask, Gateway, DNS Server

Show or specify:

- The instrument's IP address.
- The IP subnet mask used by the instrument.
- The IP gateway used by the instrument.
- The address of the domain name server.

Remote command:

[SYSTem:COMMunicate:INTerface:ETHernet:IPAdDress](#) on page 430

[SYSTem:COMMunicate:INTerface:ETHernet:SUBNet](#) on page 430

[SYSTem:COMMunicate:INTerface:ETHernet:GATeway](#) on page 430

IP Port, VXI-11 Port

Specify the IP port number (default = 5025) and the VXI-11 port number (default = 1024).

Remote command:

`SYSTem:COMMunicate:INTerface:ETHernet:IPPort` on page 431

`SYSTem:COMMunicate:INTerface:ETHernet:VXIPort` on page 431

Link

"Yes", if the instrument is connected to a local area network via the LAN interface on the rear panel.

"No", if no LAN connection is detected.

Transfer

Enables automatic transfer speed selection and shows the currently selected value.

Alternatively, you can select one of the predefined settings that corresponds to your network data rate.

Remote command:

`SYSTem:COMMunicate:INTerface:ETHernet:TRANsfer` on page 431

MAC, VISA

Show the instrument's media access control address, and the virtual instrument software architecture (VISA) address that is used to address the instrument in remote control.

Remote command:

`SYSTem:COMMunicate:INTerface:ETHernet:MACaddress?` on page 431

Host name

Shows or specifies the name of the instrument, which the instrument can use to connect to the DHCP server.

Status

Shows the connection status, for example "Allocating network address" or "DHCP, IP address received".

Password

Specifies an optional password for remote access to the instrument.

Reset

Deletes all IP address settings, and removes the address from the VISA string. All other settings are set to default values.

Save

Retrieves a DHCP address from the DHCP server or checks the manual IP address, updates the VISA string, checks connection and saves all settings in the instrument.

11.2 USB Connection

In addition to a LAN connection, you can use the USB connector at the rear panel to access the instrument via USB.

Connecting the instrument using USB

1. Connect the USB cable to the USB type B connector at the rear panel of the instrument, and to the computer.
2. Open the "Setup" menu.
3. Tap "Interface".



4. Tap "USB" to select USB connection.
5. Tap "Parameter".
6. Select the USB mode.
 - USB TMC (Test & Measurement Class)
 - USB VCP (Virtual Com Port)
 - USB MTP (Media Transfer Protocol)

11.2.1 USB TMC

USB TMC means USB Test & Measurement Class. You can use this interface for remote control of the instrument using SCPI commands. USB TMC does not need a driver installation but requires a VISA installation on the controlling computer. VISA is used to access the instrument, to send remote commands, and to read status information.

Rohde & Schwarz provides the standardized I/O software library R&S VISA for communication via TCP/IP (LAN: HiSlip, VXI-11) or USB (USBTMC) interfaces. R&S VISA is available for download at the Rohde & Schwarz website www.rohde-schwarz.com/rsvisa.

11.2.2 USB VCP

USB VCP uses the virtual COM port (VCP) to communicate with the measuring instrument. You can use any terminal program to send SCPI commands. USB VCP requires a USB VCP driver on the controlling computer. If the computer requests a driver installation, you can download the driver at the Rohde & Schwarz website (www.rohde-schwarz.com/de/treiber/hmo/, HO732). You need administrator rights to install the driver.

11.2.3 USB MTP

USB MTP is the USB media transfer protocol. It is a solution to load data from the oscilloscope to the computer. Remote control using SCPI commands is not possible.

USB MTP does not need a driver installation. If the instrument and the computer are connected with a USB cable and USB MTP is selected as interface, you can access the oscilloscope data from the computer. You see the oscilloscope in the computer's Device Manager and in the file explorer as portable instrument.

11.3 Remote Access Using a Web Browser

The R&S RTB2000 firmware contains a web server. If a LAN connection is established, you can access the instrument remotely using a web browser on the control computer.

The browser access allows you to:

- Check instrument data
- Save and print screenshots
- Send remote commands
- Save waveform and instrument data
- Check network settings
- Change the password
- See a live view of the display
- Control the instrument remotely

11.3.1 Accessing the Instrument Using a Web Browser

To access the R&S RTB2000, you need a LAN connection and the IP address of the instrument.

1. Obtain the IP address of the R&S RTB2000:
 - Tap the green network icon in the top right corner of the screen.

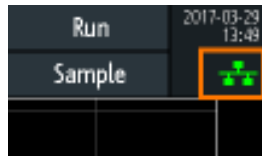

- "Setup" menu > "Interface" > "Ethernet" > "Parameter" > "IP".
2. Open an Internet browser on the control computer.
 3. Enter the IP address of the R&S RTB2000 in the address line: `http://xxx.yyy.zzz.xxx`.
The "Instrument Home" page opens.

If already another user is using the instrument via web access, connection is not possible, and you get an information about that.

11.3.2 Instrument Home

The "Instrument Home" page provides information on the instrument and the LAN connection.

Instrument Home		Ethernet Port	
Manufacturer:	Rohde&Schwarz	Description:	Rohde&Schwarz RTB2004 - 101136
Device Class:	Oscilloscope	Host name:	R-RTB2004-01136.local
Device Type:	RTB2004	MAC-Address:	90-90-B8-1F-19-00
Serial Number:	1333.1005k04/101136	IP Mode:	Automatic
Firmware Version:	02.000	IP Address:	10.124.1.15
		Subnet mask:	255.255.252.0
		Default Gateway:	10.124.0.1
		DNS Server:	10.0.23.153
		IP Port:	5025
		Transfer:	100 Mbps - Full Duplex
		VESA Resource String:	TCPIP::10.124.1.15::INSTR
		Device Identification:	<input type="radio"/> On <input checked="" type="radio"/> Off
		USB Device Port:	
		Vendor ID:	0A4D (hex)
		Product ID:	01D7 (hex)

11.3.3 Screenshot

The "Screenshot" page shows a copy of the instrument's display. It also provides instrument control functions and screenshot settings.

Instrument control

- "Run" and "Stop" = start and stop continuous acquisition, same as [Run Stop] key on the instrument.
- "Single" = Single key on the instrument
- "Autoset" = [Autoset] key on the instrument

- "Preset" = [Preset] key on the instrument



Screenshots

- "Auto refresh" and "Update"
Get the current screen content from the instrument. With "Auto refresh", you can set the interval of automatic updates.
 - "Format" and "Color mode":
Set the file format and color mode of the screenshot.
- To save the screenshot, *right-click the picture* and select "Save image as".

11.3.4 SCPI Device Control

On the "SCPI Device Control" page, you can check how the transfer of remote commands is working.

You can enter a single command, for example; *IDN?, and transmit it with "Send". Do not press the [Enter] key.

If the sent command has an error, an error message is created in the background, and you do not get any response. You can see the error messages using "Last Error Message" and "All Error Messages"

SCPI Device Control

The device may be controlled with special commands (SCPI - **S**tandard **C**ommands for **P**rogrammable **I**nstruments). Please take the respectively valid instruction set from the documentation delivered with the device. If you type a wrong command or use a wrong syntax, the device creates an error message which is not send immediately, complying with the standard, but can be requested separately. In this case you will **not** get a response. An easy way to request the error messages is to use the two buttons.

Command:

Response:

Rohde&Schwarz,RTB2004,1333.1005k04/900012,01.200

11.3.5 Save/Load

On the "Save/Load" page, you can save waveform data and instrument settings to a file - either on the computer (local host) or on the instrument. On the computer, the default storage directory is the download folder, but you can change the directory using the download functions of your browser. On the instrument, the files are saved in the internal storage.

You can also load reference waveforms and instrument settings from file to the instrument ("Load from local host").

To save data to a file on the computer

1. Under "Save to local file", select the waveform or the device settings in the "Source" list.
2. Select the file "Format".

See also:

- [Chapter 9.2.2, "Waveform File Formats"](#), on page 158
- [Chapter 6.3, "Reference Waveforms"](#), on page 83

3. For analog and digital channels, select whether you want to read out the display memory ("Display Data") or the entire acquisition memory ("Acq. Memory").

- Click "Save".

Save/Load

If you want to save a waveform to a file, you first have to select the waveform, format and data. The number of samples and the file size will be indicated below. To download the waveform file, use the "Save" button.

Save to local host

Source: Format: Points:

Source: Channel 1
 Samples: 100000
 File size (approx.): 1123 kB
 Sample number may be reduced due to running acquisition.

Load from local host (max. 256 kB)

Destination: Source File:

Save to file on instrument

Source: Dest. File:

Load from file on instrument

Destination: Source File:

11.3.6 Network Settings

On the "Network Setting" page, you can change the port settings, switch off DHCP address and enter an IP address in a more comfortable way than directly on the instrument. To take effect of the changes, "Submit" them to the instrument.

"Reset" removes all modified values that were not yet sent to the instrument.

Network Settings[Print view](#) 

Warning: Changing the network settings may result in loss of connection!

Host name	<input type="text" value="R-RTB2004-01136"/>
Description	<input type="text" value="Rohde&Schwarz RTB2004 - 101136"/>
IP Mode	<input checked="" type="radio"/> Automatic <input type="radio"/> Manual
IP Address	<input type="text" value="10"/> . <input type="text" value="124"/> . <input type="text" value="1"/> . <input type="text" value="15"/>
Subnet mask	<input type="text" value="255"/> . <input type="text" value="255"/> . <input type="text" value="252"/> . <input type="text" value="0"/>
Default Gateway	<input type="text" value="10"/> . <input type="text" value="124"/> . <input type="text" value="0"/> . <input type="text" value="1"/>
DNS Server	<input type="text" value="10"/> . <input type="text" value="0"/> . <input type="text" value="23"/> . <input type="text" value="153"/>
IP Port	<input type="text" value="5025"/>
Transfer	<input type="text" value="Auto"/> ▼
	<input type="button" value="Submit"/> <input type="button" value="Reset"/>

11.3.7 Change Password

On the "Change Password" page, you can change or remove the password to protect remote access to the instrument. Alternatively, you can change the password in the Ethernet settings dialog on the instrument.

11.3.8 Livescreen

You see a live view of the instrument's display. Controlling the instrument is not possible, and only one remote connection to the livescreen is allowed at a time. Use this page for demo purposes, for example.

To close the livescreen, select "Instrument Home".

11.3.9 Remote Front Panel

On the "Remote Front Panel" page, you can remotely operate the instrument using the emulated front panel. A live view of the instrument's front panel is shown. You can use the keys, the knobs and the menus in the same way as directly on the instrument. Only one remote connection to the remote front panel is allowed at a time.

To close the "Remote Front Panel", select "Instrument Home".

12 Serial Bus Analysis

Using the R&S RTB2000 and additional options, you can analyze the following serial protocols:

- SPI no CS (Serial Peripheral Interface with 2 lines) and SPI with CS (Serial Peripheral Interface with 3 lines) - requires option R&S RTB-K1
See [Chapter 12.2, "SPI Bus \(Option R&S RTB-K1\)"](#), on page 198.
- I²C (Inter-Integrated Circuit bus) - requires option R&S RTB-K1
See [Chapter 12.3, "I²C \(Option R&S RTB-K1\)"](#), on page 206.
- UART/RS232 (EIA-232 serial interface) - requires option R&S RTB-K2
See [Chapter 12.4, "UART / RS232 \(Option R&S RTB-K2\)"](#), on page 215.
- CAN (Controller Area Network) - requires option R&S RTB-K3
See [Chapter 12.5, "CAN \(Option R&S RTB-K3\)"](#), on page 222.
- LIN (Local Interconnect Network) - requires option R&S RTB-K3
See [Chapter 12.6, "LIN \(Option R&S RTB-K3\)"](#), on page 236.

To analyze parallel buses, you need MSO option R&S RTB-B1 to get the logic channels. See [Chapter 13, "Logic Analyzer \(Option R&S RTB-B1, MSO\)"](#), on page 250.

12.1 Basics of Protocol Analysis

The analysis of serial data consists of the following main steps:

- Protocol configuration:
Select the protocol type, configure the input lines and the protocol-specific settings.
- Decoding:
Select the display format of the decoded data. The digitized signal is displayed on the screen together with the decoded content of the messages in combs. You can scale the signal display and zoom into it to see it in more detail.
You can also list the decoded results in tabular form in the bus table.
- Triggering:
You can trigger on various events that are typical for the configured bus type. For example, trigger on start or stop of messages, or on serial patterns.
- Search:
On CAN and LIN buses, you can search for events. The search events are similar to the trigger events. The search finds all matching events in an acquisition, while the trigger finds only the trigger event.

Analysis can be performed on analog and digital input channels. Digital channels require if MSO option R&S RTB-B1.

You can configure 2 protocol buses and select one of the configured buses for analysis.

- Protocol - Common Settings..... 189
- Displaying Decode Results..... 191
- Bus Table: Decode Results..... 192
- Bus Labels..... 194
- Label List..... 195

12.1.1 Protocol - Common Settings

- ▶ To open the protocol setup, press the [Protocol] key.

The common settings in the "Protocol" menu define the bus type and open further menus to adjust the display of the decoded bus signal.

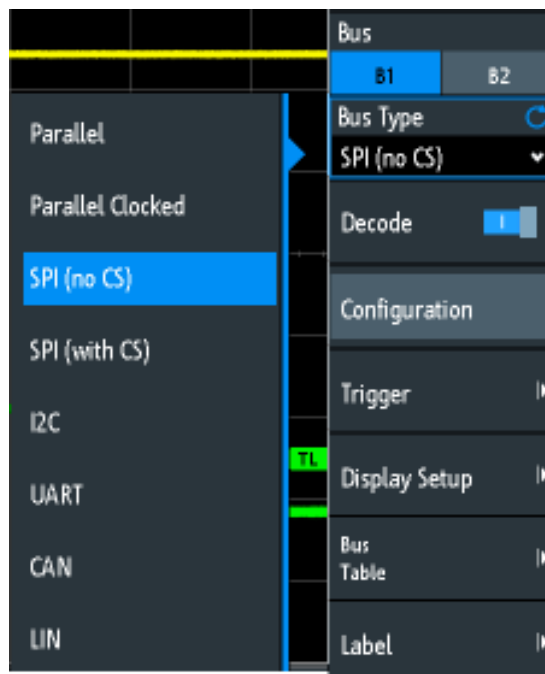

Figure 12-1: Protocol menu with bus types expanded

Bus

Selects the bus to be configured and analyzed.

Bus Type

Defines the bus or interface type for analysis. Available buses depend on the installed options.

Remote command:

`BUS : TYPE` on page 434

Decode

Enables protocol decoding for the selected bus.

Remote command:

[BUS : STATE](#) on page 434

Configuration

Opens or closes the dialog box with configuration settings of the selected bus.

The following chapters describe manual protocol configuration:

- [Chapter 13.5, "Parallel Buses"](#), on page 254
- [Chapter 12.2.2, "SPI Configuration"](#), on page 199
- [Chapter 12.3.2, "I²C Configuration"](#), on page 208
- [Chapter 12.4.2, "UART Configuration"](#), on page 216
- [Chapter 12.5.2, "CAN Configuration"](#), on page 224
- [Chapter 12.6.2, "LIN Configuration"](#), on page 238

Trigger

Opens the trigger setup for the selected protocol.

The following chapters describe protocol triggering:

- [Chapter 12.2.3, "SPI Trigger"](#), on page 202
- [Chapter 12.3.3, "I²C Trigger"](#), on page 209
- [Chapter 12.4.3, "UART Trigger"](#), on page 219
- [Chapter 12.5.3, "CAN Trigger"](#), on page 226
- [Chapter 12.6.3, "LIN Trigger"](#), on page 240

Triggering on parallel buses is not possible.

Note: Selecting "Trigger" in the protocol menu automatically enables protocol decoding.

Display Setup

Opens a menu to define display settings, e.g. data formats. Display settings are valid for all protocol types.

See [Chapter 12.1.2, "Displaying Decode Results"](#), on page 191.

Label List

Opens a menu to load and apply a list with symbolic names of addresses or identifiers. Only available for CAN and LIN.

See [Chapter 12.1.5, "Label List"](#), on page 195.

Bus Table

Opens a menu to define bus table settings for the decoded frames of the acquisition.

See [Chapter 12.1.3, "Bus Table: Decode Results"](#), on page 192.

Label

Opens a menu to define a label for the selected bus.

See [Chapter 12.1.4, "Bus Labels"](#), on page 194.

12.1.2 Displaying Decode Results

When the configuration of a serial bus is complete, the instrument can decode the signal. The decode results are displayed in two ways:

- Bus signal with combs, time-correlated to the input signals. The combs show the values of the frames or words.
- Bus table. The table lists data values and time information of the frames or words. For details, see [Chapter 12.1.3, "Bus Table: Decode Results"](#), on page 192.

To decode a serial bus

- ▶ In the "Bus" menu, enable "Decode".

The bus signal with combs is shown. The colors of the combs are protocol-specific and described in the "Decode Results" chapters of the protocol description.

To adjust scaling and position of the decoded bus signal

1. The horizontal size of the combs is defined by the horizontal time scale, which is the same for input signals and the bus signal. Turn the horizontal [Scale] knob to change the time scale.
2. To adjust the trigger position, turn the horizontal [Position] knob.
3. The vertical size and position are specific for the selected bus signal.
 - a) Tap the bus signal to set the focus to it.
 - b) Turn the vertical [Scale] knob to set the height of the combs.
 - c) Turn the upper knob in the Vertical section to move the bus signal vertically on the screen.
 - d) To set the signal to the center of the display, press the upper knob in the Vertical section.

Remote commands

- [BUS:DSIZE](#) on page 436
- [BUS:POSition](#) on page 436

To set the data format and bit display

1. Press the [Protocol] key.
2. Select "Display Setup".

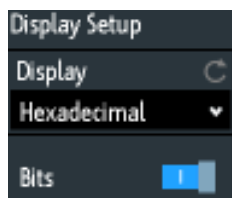

Display

Selects the decoding format of the data: binary, hexadecimal, decimal, octal or ASCII. The setting applies to the data in the combs of the decoded bus line, and to the bus table.

Remote command:

BUS:FORMat on page 435

Bits

Enables the display of the individual bit lines above the decoded bus line.

Remote command:

BUS:DSIGnals on page 435

12.1.3 Bus Table: Decode Results

The bus table shows the detailed decoded data for each frame of the acquisition. At running acquisition, the table results are updated continuously. In stop mode, you can access the individual frames and analyze them. You can also save the results to CSV file.

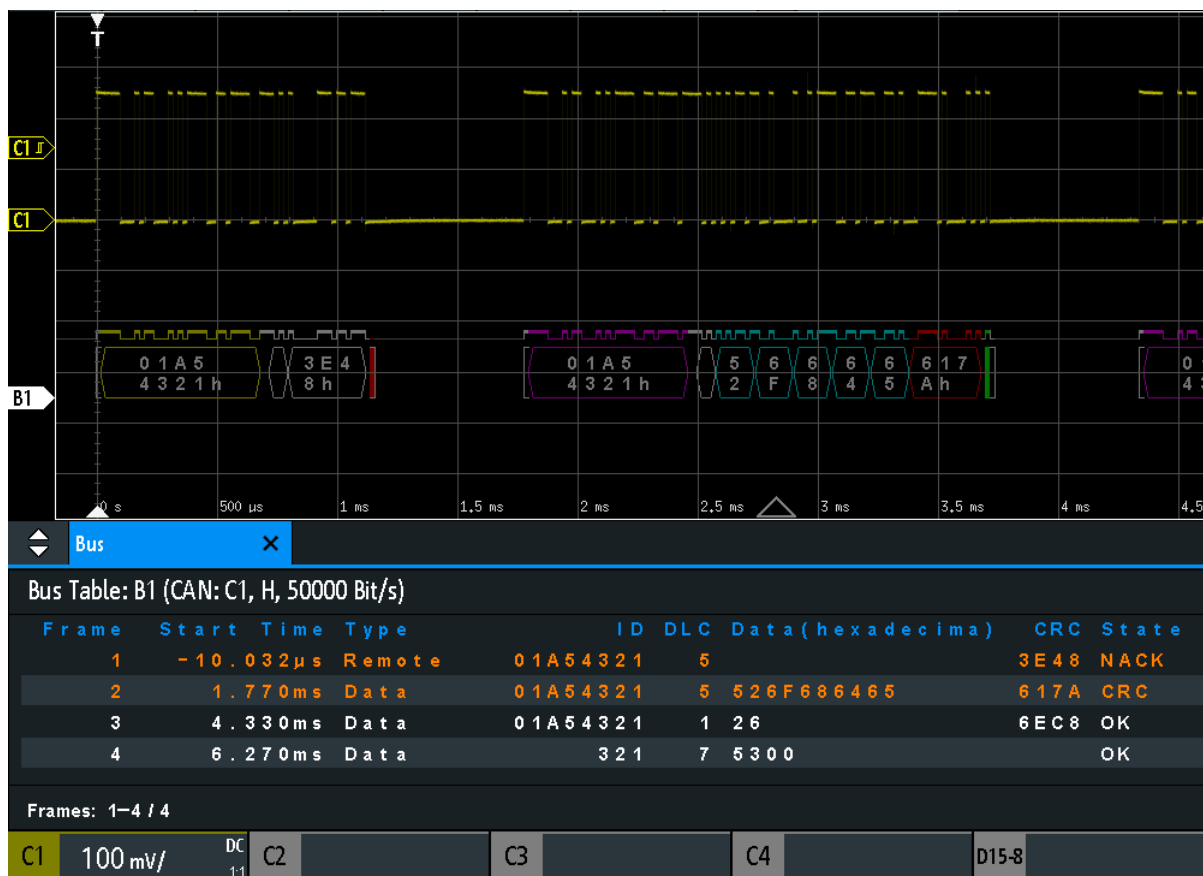

Figure 12-2: Example of a bus table: decode results of a CAN bus

To open the bus table

1. In the "Bus" menu, select "Bus Table".
2. Select "Bus Table".

The menu entry gets highlighted, and the bus table is shown below the diagram.

To navigate in the bus table

1. To adjust the table size, drag up or down one of the arrow buttons on the left or right.
2. Stop the acquisition.
3. In the "Bus Table" menu, select "Track Frame".
4. Tap a frame in the bus table.

The start of the selected frame is marked by a line and a rhomb. This marker is moved to the center of the diagram, followed by the decoded data.

To save the bus table

1. If you want to save the data outside the instrument, connect a USB flash drive.
2. Tap the "Save" symbol in the upper right corner of the bus table.
3. Select the correct "Destination" and the path.
You can also store the data on the instrument. Therefore, select the "Destination" "/INT/BUSTABLE".
4. If necessary, change the filename and enter a comment.
5. Tap "Save".

The data is saved to a CSV file.

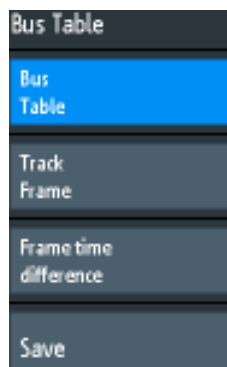
Bus table menu**Bus Table**

Displays or hides a table of decoded signal data.

Remote command:

`BUS:RESuLt` on page 436

Track Frame

If enabled, the selected frame in the bus table is automatically synchronized with the waveform display.

The function is only available if the acquisition has been stopped.

Frame time difference

If selected, the time column in the bus table shows the frame's time difference to the previous frame. The column is indicated with "Time diff.". If the setting is disabled, the absolute time in relation to the trigger point is shown in the "Start Time" column.

Save

Opens the "Save" menu to save the decoded data in a CSV file (comma-separated list).

12.1.4 Bus Labels

A bus label is a name of a bus. The bus label is shown on the right side of the display at the bus signal, and in the bus table.

Do not confuse "Label" and "Label List". The "Label" names the bus, while the "Label List" contains the names of bus nodes identified by addresses or identifiers.

Access: [Protocol] > "Label"

**Label**

Displays or hides the bus label. The bus label is shown on the right side of the display at the bus signal, and in the bus table. The bus and its label are only visible, if "Decode" is enabled.

You can enter a label text in several ways:

- Select a string from the library list with "Predefined Label".
- Enter a user-defined text using "Edit Label".

Remote command:

[BUS:LAbel:STATe](#) on page 435

Predefined Label

Selects a predefined label text. You can edit the text with "Edit Label".

Edit Label

Opens on-screen keypad to enter a label text. If you previously have selected a predefined label, it is already written in the entry line, and you can modify it.

The maximum name length is 8 characters, and only ASCII characters provided on the on-screen keypad can be used.

Remote command:

[BUS:LABel](#) on page 435

12.1.5 Label List

For all protocols using ID or address identification, it is possible to create label lists containing addresses or IDs, a symbolic name for each node (symbolic label), and some protocol-specific information.

You can load label lists, and activate its usage for decoding. As a result, the decoded signal shows the symbolic label instead of the ID or address values, so it is easy to identify the messages of the different bus nodes.

You can also use the label list to trigger on an identifier or address. Instead of entering the value, you select the name, which is defined in the label list.

The format of label list files is PTT.

Label lists are protocol-specific. They are described in the corresponding protocol chapters:

- [Chapter 12.5.6, "CAN Label List"](#), on page 234
- [Chapter 12.6.6, "LIN Label List"](#), on page 247

12.1.5.1 Using Label Lists

To load a label list and display the labels

1. Save the label list file on a USB flash drive.
2. Press the [Protocol] key.
3. Configure the protocol.
4. In the "Bus" menu, select "Label List".

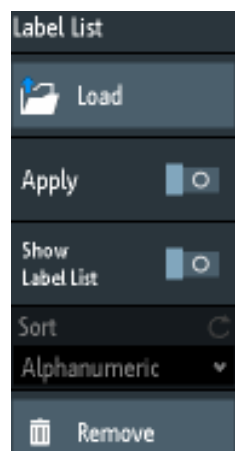

5. Select "Load".
6. Navigate to the label list file, select it, and tap "Load".
7. To read the label list, tap "Show Label List".
8. To see the node labels in the display of the decoded data, tap "Apply".

To trigger on an identifier or address using the label

Prerequisites: The bus is configured, decoding is enabled, and a decoded signal is visible.

1. Open the "Bus" menu.
2. Select "Trigger".
3. Set the following trigger settings:
 - a) "<Protocol> Trigger" = "Identifier", or "Identifier + Data", or "Address", or "Address and Data".
 - b) Tap "Symbolic ID".
 - c) Select the label. The list provides all symbolic names that are defined in the loaded file.
4. Close the dialog.
5. Set the trigger mode to "Normal".

12.1.5.2 Content and Format of the PTT File

Label lists are stored as PTT (protocol translation table) files. The PTT file format is an extension of the CSV format (comma-separated values). You can edit it with standard editors, for example, with MS Excel or a text editor.

The PTT file has three types of lines:

- Comment lines begin with a hash character #. A hash character at any other position in the line is treated like a standard character.
- Command lines begin with a commercial at character @. An @ character at any other position in the line is treated like a standard character.
- Standard lines are the lines that not qualify as comment or command lines. They build the core of the label list.

Command lines

Command lines define the version of the PTT file and the protocol name:

- @FILE_VERSION: must appear exactly once in the file
- @PROTOCOL_NAME: must appear at least once in the file. Thus, one file can contain several label lists for different protocols.

```
# --- Start of PTT file
@FILE_VERSION = 1.0
@PROTOCOL_NAME = i2c
[... Label list for I2C]
```

```
@PROTOCOL_NAME = can
[... Label list for CAN]
# --- End of PTT file
```

Standard lines

Standard lines define the contents of the label list. The rules for standard lines follow the csv convention, they are:

- Values are separated by commas
- Space characters following a delimiter are ignored
- Values with a special character (comma, newline, or double quote) must be enclosed in double quotes
- Text in double quotes must be escaped by double quote characters

The format of the numeric value is indicated by a suffix. The following formats are supported:

Format	Suffix	Example
Decimal	<empty> d	106, DeviceName 106d, DeviceName
Hexadecimal	h	6Ah, DeviceName or prefix: 0x6A, DeviceName
Octal	o	152o, DeviceName
Binary	b	01101010b, DeviceName

The maximum supported word size for (unsigned) integers is 64 bits.

```
# --- Start of PTT file
@FILE_VERSION = 1.0
@PROTOCOL_NAME = i2c
#   Following two lines are equal:
7,01h, Temperature
7,01h, Temperature
#   A comma must be enclosed in double quotes:
7,01h, "Temperature, Pressure, and Volume"
#   A double quote must also be enclosed in double quotes:
7,7Fh, "Highspeed ""Master"" 01"
#   Following lines yield the same result:
7d,0x11, Pressure
7h,11h, Pressure
0x7,17d, Pressure
7,17, Pressure
```

12.2 SPI Bus (Option R&S RTB-K1)

• The SPI Protocol.....	198
• SPI Configuration.....	199
• SPI Trigger.....	202
• SPI Decode Results	205

12.2.1 The SPI Protocol

A 4-channel instrument is required for full support of the SPI protocol, or the MSO option R&S RTB-B1.

The Serial Peripheral Interface SPI is used for communication with slow peripheral devices, in particular, for transmission of data streams.

Main characteristics of SPI are:

- Master-slave communication
- No device addressing; The slave is accessed by a chip select, or slave select line.
- No acknowledgement mechanism to confirm receipt of data
- Duplex capability

Most SPI buses have four lines, two data and two control lines:

- Clock line to all slaves (SCLK)
- Slave Select or Chip Select line (SS or CS)
- Master data output, slave data input (MOSI or SDI)
- Master data input, slave data output (MISO or SDO)

When the master generates a clock and selects a slave device, data may be transferred in either or both directions simultaneously.

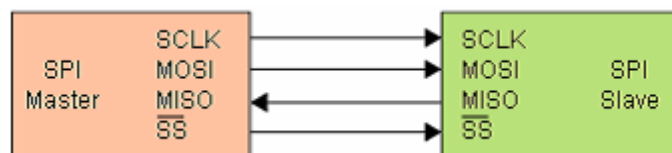

Figure 12-3: Simple configuration of SPI bus

The data bits of a message are grouped by following criteria:

- A word contains a number of successive bits. The word length is defined in the protocol configuration.
- A frame contains a number of successive words, at least one word.

For SPI buses, the R&S RTB2000 provides the following trigger possibilities:

- On frame start
- On frame end
- On a specified bit in the message
- On a serial pattern at a specified position

12.2.2 SPI Configuration

The correct setup of the protocol parameters and the threshold is the condition for decoding the signal.

To set up and decode an SPI signal (with or without CS)

1. Press the [Protocol] key in the Analysis area of the front panel.
2. Select the bus that you want to use: B1 or B2.
3. Select the "Bus Type" = "SPI (no CS)" or "SPI (with CS)".
4. Select "Configuration".
5. Select the sources of the signal lines, the channels to which the lines are connected.
6. Set the threshold. Use one of the following methods:
 - Tap "Find Threshold". The instrument evaluates the signal and sets the threshold.
 - Enter the threshold value in the numeric field.
7. Set the other signal parameters according to the signal characteristics. All settings are described below.
8. In the "Bus" menu, enable "Decode".

SPI configuration settings

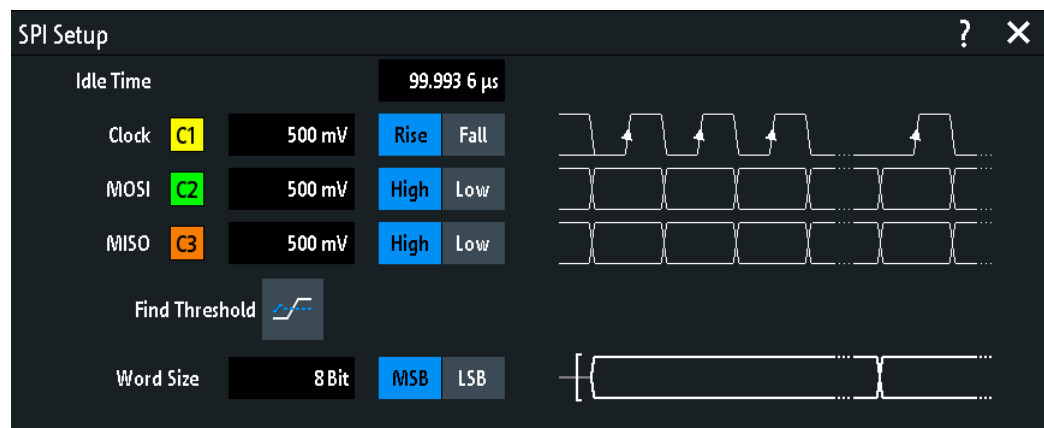

Figure 12-4: SPI (no CS) setup

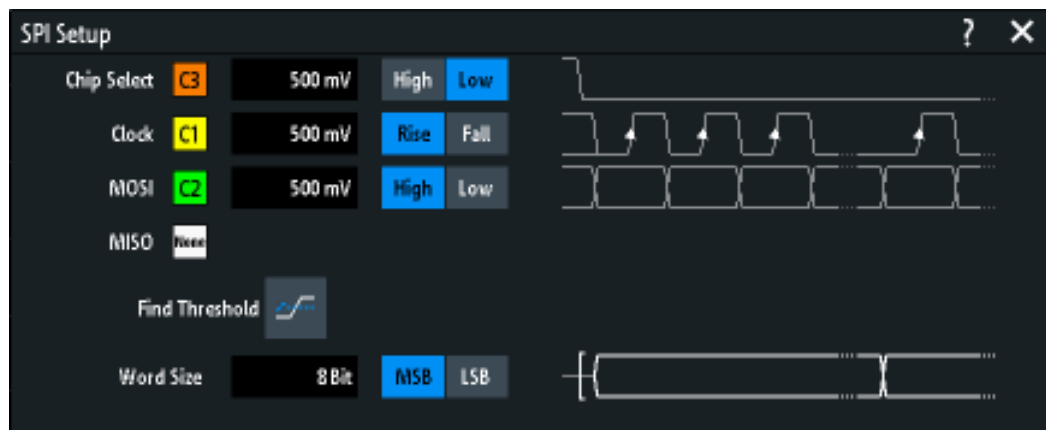

Figure 12-5: SPI (with CS) setup

Chip Select.....	200
Clock.....	200
Slope.....	200
MOSI / MISO / Data.....	200
Polarity.....	201
Threshold, Find Threshold.....	201
Word Size.....	201
Idle Time.....	201

Chip Select

Selects the input channel of the chip select (CS) line. Only available in the "SPI (with CS)" setup.

If the MSO option R&S RTB-B1 is installed, you can use logic channels as source.

Remote command:

[BUS:SPI:CS:SOURce](#) on page 437

Clock

Selects the input channel of the clock line.

If the MSO option R&S RTB-B1 is installed, you can use logic channels as source.

Remote command:

[BUS:SPI:CLOCK:SOURce](#) on page 438

[BUS:SSPI:CLOCK:SOURce](#) on page 440

Slope

Selects if data is sampled on the rising or falling slope of the clock. The clock slope marks the begin of a new bit.

Remote command:

[BUS:SPI:CLOCK:POLarity](#) on page 438

[BUS:SSPI:CLOCK:POLarity](#) on page 441

MOSI / MISO / Data

Select the input channel of the data lines. MOSI is mandatory, the MISO line is optional.

If the MSO option R&S RTB-B1 is installed, you can use logic channels as source.

Note: MISO is available only on bus 1. On bus 2, you can set only one "Data" line. The MISO line occupies a second bus line. Thus, if MISO is used on bus 1, bus 2 is not available.

Remote command:

[BUS:SPI:MOSI:SOURce = BUS:SPI:DATA:SOURce](#) on page 438

[BUS:SPI:MISO:SOURce](#) on page 438

[BUS:SSPI:MOSI:SOURce = BUS:SSPI:DATA:SOURce](#) on page 441

[BUS:SSPI:MISO:SOURce](#) on page 441

Polarity

Selects if the transmitted signal is high active (high = 1) or low active (low = 1).

For CS, the default is low active.

For MOSI / MISO, the default is high active.

For data, the default is high active.

Remote command:

[BUS:SPI:MOSI:POLarity = BUS:SPI:DATA:POLarity](#) on page 439

[BUS:SPI:MISO:POLarity](#) on page 439

[BUS:SSPI:MOSI:POLarity = BUS:SSPI:DATA:POLarity](#) on page 441

[BUS:SSPI:MISO:POLarity](#) on page 442

Threshold, Find Threshold

Set the signal threshold for the source channel. Enter a value, or use "Find Threshold" to set the threshold to the middle reference level of the measured amplitude.

For analog channels, you can find the value also in the "Vertical" menu > "Channel <n>" > "Threshold"

For logic channels, you can find the value also in the "Logic" menu > "Threshold".

Remote command:

[CHANnel<m>:THReshold](#) on page 296

[CHANnel<m>:THReshold:FINDlevel](#) on page 297

[DIGital<m>:THReshold](#) on page 499

Word Size

Sets the word length (or symbol size), which is the number of bits in a message. The maximum word length is 32 bit.

You can also define the bit order, which determines if the data of the messages starts with "MSB" (most significant bit) or "LSB" (least significant bit).

Remote command:

[BUS:SPI:SSIZe](#) on page 440

[BUS:SSPI:SSIZe](#) on page 443

[BUS:SPI:BORDER](#) on page 439

[BUS:SSPI:BORDER](#) on page 442

Idle Time

Sets the burst idle time, during which the data and clock lines are low. Only available in the "SPI (no CS)" setup.

A new frame begins when the idle time has expired and the clock line has been inactive during that time. If the time interval between the data words is shorter than the idle time, the words are part of the same frame.

Remote command:

`BUS:SSPI:BITime` on page 442

12.2.3 SPI Trigger

Before you set up the trigger, make sure that the bus is configured correctly. See [Chapter 12.2.2, "SPI Configuration"](#), on page 199.

To trigger on SPI signals:

1. Press the [Protocol] key in the Analysis area of the front panel.
2. Select the bus that is configured for SPI.
3. Select "Trigger".

This selection has several effects:

 - Enables decoding, if necessary.
 - Sets the "Trigger Type" to "Serial Bus" and the trigger source to the selected bus.
 - Displays the "SPI Trigger" condition in the dialog box, below the protocol setup.
4. Check the "Source" and change it if necessary.
5. At "SPI Trigger", select the required trigger type:
 - "Frame Start": beginning of the message
 - "Frame End": end of the message
 - "Bit <x>": a specified bit inside the message
 - "Serial Pattern": a bit pattern in the message
6. If "Serial Pattern" is selected, the SPI trigger setup dialog expands to define the serial pattern.

SPI trigger settings

The trigger settings are shown in the dialog below the bus configuration settings. In the trigger menu, you select the trigger source, and open or close the setup dialog box.

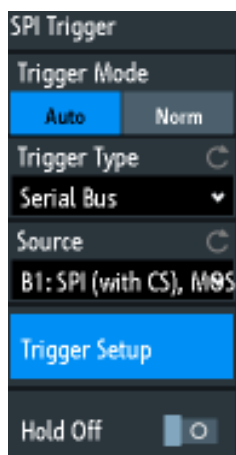

Figure 12-6: SPI trigger menu

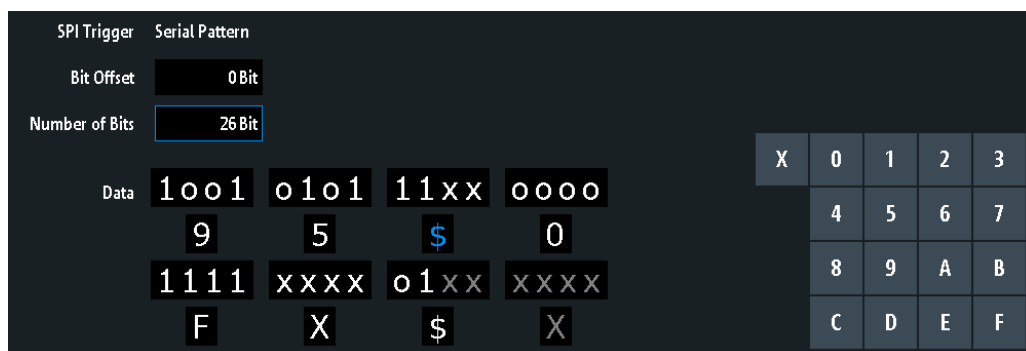

Figure 12-7: SPI trigger settings with an example of an SPI serial pattern

- 9 = Hex value of the 1st nibble, with the binary value 1001
- \$ (blue) = Hex value of the 3rd nibble, which includes some "X" bits. The blue color indicates that the keypad is active for this nibble.
- X (white) = The 6th nibble is a "don't care" nibble, as it consists of "X" bits, only
- \$ (white) = The 7th nibble is only half contained in the specified pattern length of 26 bits
- X (gray) = The 8th nibble is not contained in the specified pattern

Source.....203

SPI Trigger.....203

Bit Offset.....204

Number of Bits.....204

Data.....204

Source

If both MOSI and MISO lines are configured for analysis, select which line is the trigger source.

Remote command:

[TRIGger:A:SOURce:SPI](#) on page 443

SPI Trigger

Selects the trigger condition.

- "Frame Start" Sets the trigger to the start of the message:
- For SPI with CS, the frame starts when the chip select signal CS changes to the active state.
 - For SPI without CS, the frame starts when the idle time has expired.
- "Frame End" Sets the trigger to the end of the message.
- For SPI with CS, the frame ends when the chip select signal CS changes to the inactive state.
 - For SPI without CS, the frame ends when the idle time has expired after the last clock and no new clock appeared during that time.
- "Bit <x>" Sets the trigger to the bit number specified with ["Bit Offset"](#) on page 204.
- "Serial Pattern" Expands the trigger setup dialog to configure the bit pattern to be triggered at. Set ["Number of Bits"](#) on page 204 and ["Data"](#) on page 204 to define the pattern, and ["Bit Offset"](#) on page 204 to define the pattern position.

Remote command:

[TRIGger:A:SPI:MODE](#) on page 443

Bit Offset

Specifies the number of bits before the first bit of the pattern. These bits are ignored. The first bit after frame start is Bit 1. For example, with bit offset = 2, Bit 1 and Bit 2 are ignored, and the pattern starts with Bit 3.

If "SPI Trigger" is set to "Bit <x>", the trigger is set to the next bit that follows the offset bits. For example, if the bit offset is 4, the instrument triggers on the start of the 5th bit.

Remote command:

[TRIGger:A:SPI:POFFset](#) on page 444

Number of Bits

Defines the length of the serial pattern in bits.

Note: Entering data bits beyond the specified length of the pattern automatically adjusts the "Number of Bits" to include all entered bits.

Remote command:

[TRIGger:A:SPI:PLENght](#) on page 444

Data

Specifies the data pattern if "SPI Trigger" is set to "Serial Pattern". When the instrument detects the specified data pattern, it sets the trigger to the first bit of this pattern.

An example of pattern definition is shown in [Figure 12-7](#).

To enter the binary value of any bit, tap this bit. To enter the hexadecimal value, tap one of the nibbles (half byte) in the lower data line.

If a nibble (half byte) contains 1, 2 or 3 "X" bits (don't care), the nibble value is represented by the character "\$". If all 4 bits of a nibble are "X", the nibble itself is "don't care", represented by the character "X".

Remote command:

[TRIGger:A:SPI:PATtern](#) on page 444

12.2.4 SPI Decode Results

When the configuration of the serial bus is complete, the signal can be decoded:

1. In the "Bus" menu, enable "Decode".
2. In the "Display" menu, select the result display settings.
See [Chapter 12.1.2, "Displaying Decode Results"](#), on page 191.
3. In the "Bus Table" menu, enable the "Bus Table". Adjust the table settings.
See also: [Chapter 12.1.3, "Bus Table: Decode Results"](#), on page 192

The instrument captures and decodes the signal according to the protocol definition and the configuration settings.

The color-coding of the various protocol sections and errors simplifies the interpretation of the visual display. The decode information condenses or expands, depending on the horizontal scale. Various data formats are available to show the result values.



Figure 12-8: Decoded SPI (no CS) signal with Bus Table. The first frame has fourteen words and the second eight words.

Table 12-1: Content of the SPI bus table

Column	Description
Start time	Time of the frame start in relation to the trigger point
Length	Number of words in the frame
Data	Hexadecimal values of the data words
State	Overall state of the frame

Remote commands are described in [Chapter 15.11.2.4, "SPI - Decode Results"](#), on page 445.

12.3 I²C (Option R&S RTB-K1)

The Inter-Integrated Circuit is a simple, low-bandwidth, low-speed protocol used for communication between on-board devices, for example, in LCD and LED drivers, RAM, EEPROM, and others.

- [The I²C Protocol](#).....206
- [I²C Configuration](#).....208
- [I²C Trigger](#).....209
- [I²C Decode Results](#)212
- [I²C Label List](#).....213

12.3.1 The I²C Protocol

This chapter provides an overview of protocol characteristics, data format, address types and trigger possibilities. For detailed information, read the "I²C-bus specification and user manual" available on the NXP manuals web page at <http://www.nxp.com/>.

I²C characteristics

Main characteristics of I²C are:

- Two-wire design: serial clock (SCL) and serial data (SDA) lines
- Master-slave communication: the master generates the clock and addresses the slaves. Slaves receive the address and the clock. Both master and slaves can transmit and receive data.
- Addressing scheme: each slave device is addressable by a unique address. Multiple slave devices can be linked together and can be addressed by the same master.
- Read/write bit: specifies if the master reads (=1) or writes (=0) the data.
- Acknowledge: takes place after every byte. The receiver of the address or data sends the acknowledge bit to the transmitter.

The R&S RTB2000 supports all operating speed modes: high-speed, fast mode plus, fast mode, and standard mode.

Data transfer

The format of a simple I²C message (frame) with 7-bit addressing consists of the following parts:

- Start condition: a falling slope on SDA while SCL is high
- 7-bit address of the slave device that either is written to or read from
- R/W bit: specifies if the data is written to or read from the slave
- ACKnowledge bits: is issued by the receiver of the previous byte if the transfer was successful
Exception: At read access, the master terminates the data transmission with a NACK bit after the last byte.
- Data: several data bytes with an ACK bit after every byte
- Stop condition: a rising slope on SDA while SCL is high

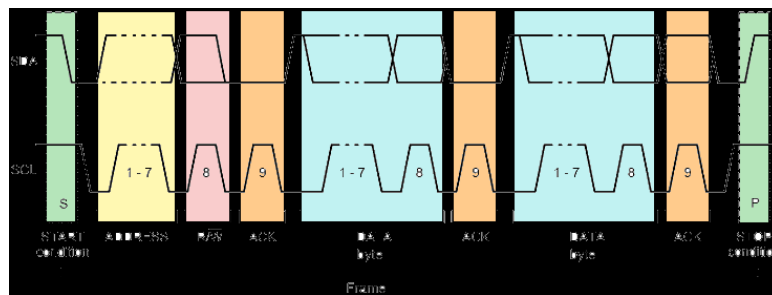

Figure 12-9: I2C writes access with 7-bit address

Address types: 7-bit and 10-bit

Slave addresses can be 7 bits or 10 bits long. A 7-bit address requires 1 byte, 7 bits for the address followed by the R/W bit.

A 10-bit address for write access requires 2 bytes: the first byte starts with the reserved sequence 11110, followed by the two MSB of the address and the write bit. The second byte contains the remaining 8 LSB of the address. The slave acknowledges each address byte.

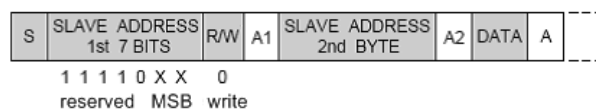

Figure 12-10: 10-bit address, write access

A 10-bit address for read access requires 3 bytes. The first 2 bytes are identical to the write access address. The third byte repeats the address bits of the first byte and sets the read bit.

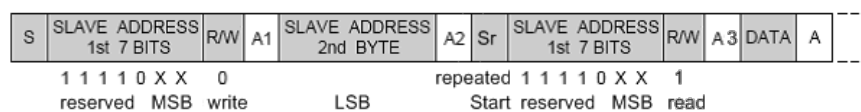

Figure 12-11: 10-bit address, read access

Trigger

The R&S RTB2000 can trigger on various parts of I²C messages. The data and clock lines must be connected to the input channels, triggering on math and reference waveforms is not possible.

You can trigger on:

- Start or stop condition
- Repeated start condition
- Transfer direction (read or write)
- Bytes with missing acknowledge bit
- Specific slave address
- Specific data pattern in the message

12.3.2 I²C Configuration

The correct setup of the protocol parameters and the threshold is the condition for decoding the signal.

To set up and decode an I²C signal

1. Press the [Protocol] key in the Analysis area of the front panel.
2. Select the bus that you want to use: B1 or B2.
3. Select the "Bus Type" = I2C.
4. Select "Configuration".
5. Select the "SCL", the channel to which the clock line is connected.
6. Select the "SDA", the channel to which the data line is connected.
7. Set the threshold. Use one of these methods:
 - Tap "Find Threshold". The instrument evaluates the signal and sets the threshold.
 - Enter the threshold value in the numeric field.
8. In the "Bus" menu, enable "Decode".

I²C configuration settings

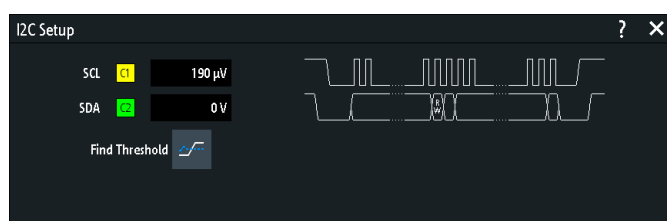

Figure 12-12: I2C setup dialog

SCL.....	209
SDA.....	209
Threshold, Find Threshold.....	209

SCL

Selects the source channel to which the clock line is connected.

If the MSO option R&S RTB-B1 is installed, you can use logic channels as source.

Remote command:

[BUS: I2C: CLOck: SOURce](#) on page 449

SDA

Selects the source channel to which the data line is connected.

If the MSO option R&S RTB-B1 is installed, you can use logic channels as source.

Remote command:

[BUS: I2C: DATA: SOURce](#) on page 449

Threshold, Find Threshold

Set the signal threshold for the source channel. Enter a value, or use "Find Threshold" to set the threshold to the middle reference level of the measured amplitude.

For analog channels, you can find the value also in the "Vertical" menu > "Channel <n>" > "Threshold"

For logic channels, you can find the value also in the "Logic" menu > "Threshold".

Remote command:

[CHANnel<m>: THReshold](#) on page 296

[CHANnel<m>: THReshold: FINDlevel](#) on page 297

[DIGital<m>: THReshold](#) on page 499

12.3.3 I²C Trigger

Before you set up the trigger, make sure that the bus is configured correctly. See [Chapter 12.3.2, "I²C Configuration"](#), on page 208.

To trigger on I²C signals:

1. Press the [Protocol] key in the Analysis area of the front panel.
2. Select the bus that is configured for I2C.
3. Select "Trigger".

This selection has several effects:

- Enables decoding, if necessary.
- Sets the "Trigger Type" to "Serial Bus" and the trigger source to the selected bus.
- Displays the trigger conditions in the dialog box, below the protocol setup.

4. At "I2C Trigger", select the required trigger type:

- "Start": beginning of the message

- "Stop": end of the message
 - "Restart": repeated start condition
 - "No Ack (Missing Ack)": transfer of data bits is not acknowledged
 - "Address and Data": address pattern and/or up to 3 data bytes
5. If "Identifier" or "Identifier and Data" is selected, the CAN trigger setup dialog expands to define the serial pattern.
 6. If "Address and Data" is selected, the I²C trigger setup dialog expands to define the serial patterns.

I2C trigger settings



Figure 12-13: Trigger setup dialog to trigger on a combination of address and data

A5 = Hex value of the 1st byte, with the binary value 10100101
 5\$ = Hex value of the 2nd byte, where the 1st nibble has the binary value 0101 and the 2nd nibble is represented by the "\$" character, as it includes one "X" bit (don't care)
 XX (gray) = The 3rd byte is not contained in the specified pattern

I2C Trigger..... 210
 Slave Address..... 211
 Symbolic ID..... 211
 Data condition.....211
 L Byte Offset..... 211
 L Number of Bytes..... 212
 L Data: Bin / Hex pattern.....212

I2C Trigger

Selects the trigger condition.

- "Start" Sets the trigger to the start of the message. The start condition is a falling slope on SDA while SCL is high.
- "Stop" Sets the trigger to the end of the message. The stop condition is a rising slope on SDA while SCL is high.

"Restart"	Sets the trigger to a repeated start - when the start condition occurs without previous stop condition. This can happen when a master sends multiple messages without releasing the bus.
"No Ack (Missing Ack)"	Missing acknowledgement: the instrument triggers, if the slave does not send the acknowledge bit. Acknowledging takes place after every byte. If the transfer failed, at the moment of the acknowledge bit, the SDA line is on high level during the high period of the clock pulse.
"Address and Data"	Sets the trigger to an address or data pattern, or a combination of both. See " Slave Address " on page 211 and " Data condition " on page 211.

Remote command:

[TRIGger:A:I2C:MODE](#) on page 450

Slave Address

Sets the slave address to be triggered on. If you want to trigger only on a data pattern and the address is not relevant, enable "Any Address".

To specify the slave address, set the following properties:

- Set the length of the slave address: "7Bit" or "10Bit".
- Toggle the trigger condition between "Read" and "Write" access of the master. The read/write bit is the 8th bit of the first address byte of a frame.
- Set the address of the slave device: enter the binary or hexadecimal address value. You need an exact address, "X" bits (don't care) are not allowed.

Remote command:

[TRIGger:A:I2C:AMODE](#) on page 451

[TRIGger:A:I2C:ACCess](#) on page 450

[TRIGger:A:I2C:ADDRess](#) on page 451

Symbolic ID

If a label list with symbolic names was loaded and applied in the bus configuration, you can select a symbolic name from the list instead of specifying the address. When you select a name, the address fields are update with its address value.

Data condition

The data condition consists of the following settings:

- Byte offset (position of the data pattern)
- Length of the data pattern
- Data pattern, see "[Bin / Hex pattern](#)" on page 230

If you want to trigger only on an address, and the data is not relevant, set all data bits to "X".

Byte Offset ← Data condition

Sets the number of offset bytes to be ignored after the end of the address bytes. The first byte of interest is the first byte after the offset bytes.

The minimum offset is 0 Bytes, the maximum offset is 4,095 Bytes.

Remote command:

[TRIGger:A:I2C:POFFset](#) on page 452

Number of Bytes ← Data condition

Sets the number of full bytes you want to trigger on. Maximum 3 bytes are possible.

Note: Entering data bits beyond the specified length of the pattern automatically adjusts the "Number of Bytes" to include defined bytes.

Remote command:

[TRIGger:A:I2C:PLENgtH](#) on page 452

Data: Bin / Hex pattern ← Data condition

Defines the data pattern in binary and hexadecimal format. To set an individual binary bit or hex nibble (half byte), tap it and enter the value on the on-screen keypad. The maximum pattern length is 3 bytes.

Remote command:

[TRIGger:A:I2C:PATTern](#) on page 451

12.3.4 I²C Decode Results

When the configuration of the serial bus is complete, the signal can be decoded:

1. In the "Bus" menu, enable "Decode".
2. In the "Display" menu, select the result display settings.
See [Chapter 12.1.2, "Displaying Decode Results"](#), on page 191.
3. In the "Bus Table" menu, enable the "Bus Table". Adjust the table settings.
See also: [Chapter 12.1.3, "Bus Table: Decode Results"](#), on page 192

The instrument captures and decodes the signal according to the protocol definition and the configuration settings.

The color-coding of the various protocol sections and errors simplifies the interpretation of the visual display. The decode information condenses or expands, depending on the horizontal scale. Various data formats are available to show the result values.

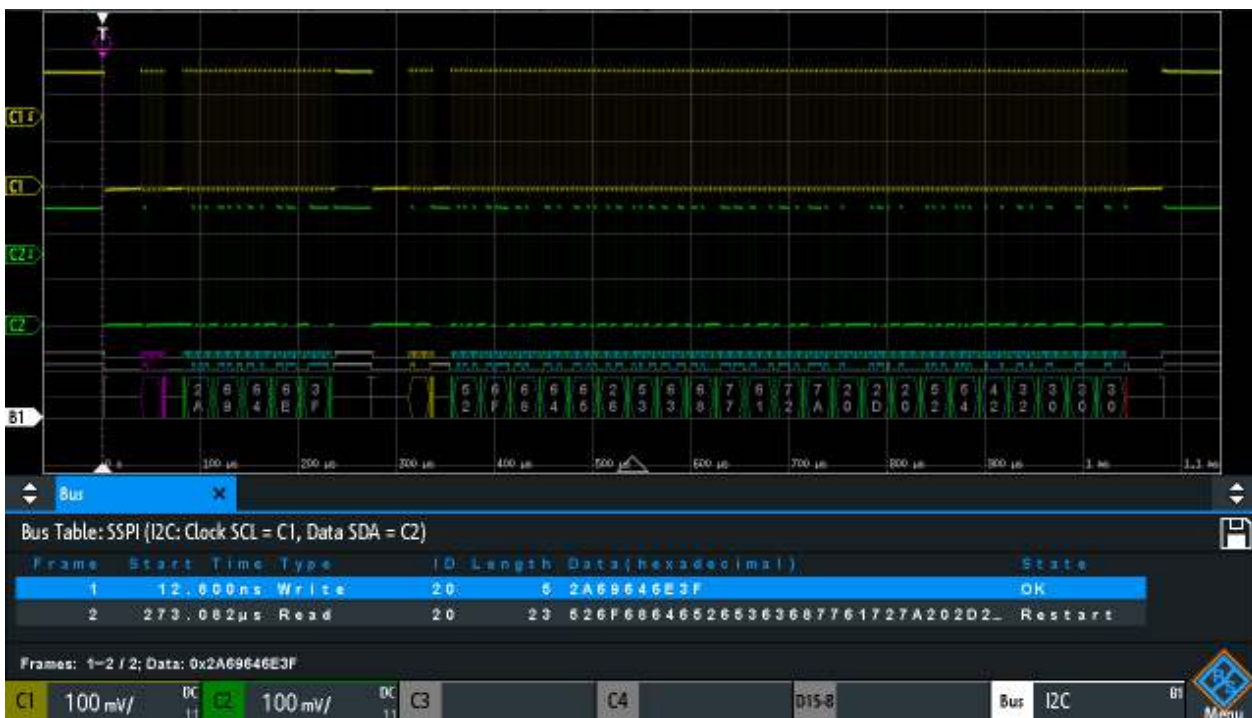

Figure 12-14: Decoded I2C signal with bus table, trigger on frame start

Gray brackets = start and end of the frame
 Violet = address
 Blue = correct data words
 Green = acknowledge bit, ok

Table 12-2: Content of the I²C frame table

Column	Description
Start time	Time of the frame start in relation to the trigger point
Type	Value of the R/W bit, read or write access
ID	Hexadecimal value of the address
Length	Number of words in the frame
Data	Hexadecimal values of the data words
State	Overall state of the frame

Remote commands are described in [Chapter 15.11.3.3, "I²C - Decode Results"](#), on page 452.

12.3.5 I²C Label List

Label lists are protocol-specific. Label lists for I²C are available in CSV and PTT format.

An I²C label file contains three values for each address:

- Address type, 7-bit or 10-bit long

- Address value
- Symbolic label: name of the address, specifying its function in the bus network.

Example: I²C PTT file

```
# -----
@FILE_VERSION = 1.00
@PROTOCOL_NAME = i2c
# -----
# Labels for I2C protocol
# Column order: Identifier type, Identifier value, Label
# -----
7,0x1E,Voltage
7,38h,Pressure
7,2Ah,Temperature
7,16h,Speed
7,118,Acceleration
7,07h,HighSpeed_Master_0x3
7,51h,EEPROM
10,3A2h,DeviceSetup
10,1A3h,GatewayStatus
10,06Eh,LeftSensor
# -----
```

For general information on label lists, see [Chapter 12.1.5, "Label List"](#), on page 195.

Label List: I2C (Imported on: 2017-03-30; 16:27)

Symbolic Label	ID / Addr
Acceleration	0x76
DeviceSetup	0x3A2
EEPROM	0x51
GatewayStatus	0x1A3
HighSpeed_Master_0x3	0x07
LeftSensor	0x06E
Pressure	0x38
Speed	0x16
Temperature	0x2A
Voltage	0x1E

Figure 12-15: Label list for I2C



Figure 12-16: Decoded I2C signal with applied label list and zoom on second frame

12.4 UART / RS232 (Option R&S RTB-K2)

- [The UART / RS232 Interface](#)..... 215
- [UART Configuration](#)..... 216
- [UART Trigger](#)..... 219
- [UART Decode Results](#) 221

12.4.1 The UART / RS232 Interface

The Universal Asynchronous Receiver/Transmitter UART converts a word of data into serial data, and vice versa. It is the base of many serial protocols like of RS-232. The UART uses only one line, or two lines for transmitter and receiver.

Data transfer

The data is transmitted in symbols, also referred to as words or characters. Each symbol consists of a start bit, several data bits, an optional parity bit, and one or more stop bits. Several symbols can form a frame, or package. The end of a frame is marked by a pause between two symbols.



Figure 12-17: Bit order in a UART word (symbol)

- The start bit is a logic 0.
- The stop bits and the idle state are always logic 1.

The UART protocol has no clock for synchronization. The receiver synchronizes by means of the start and stop bits, and the bit rate that must be known to the receiver.

Trigger

The R&S RTB2000 can trigger on specified parts of UART serial signals:

- Start bit
- Frame start
- A specified symbol
- Parity errors, and breaks
- Frame errors
- A serial pattern at any or a specified position

12.4.2 UART Configuration

The correct setup of the protocol parameters and the threshold is the condition for decoding the signal.

To set up and decode a UART signal

1. Press the [Protocol] key in the Analysis area of the front panel.
2. Select the bus that you want to use: B1 or B2.
3. Select the "Bus Type" = UART.
4. Select "Configuration".
5. Select the "TX / RX / Source", the channel to which the input signal is connected.
6. Set the threshold. Use one of the following methods:
 - Tap "Find Threshold". The instrument evaluates the signal and sets the threshold.
 - Enter the threshold value in the numeric field.
7. Set the other signal parameters according to the signal characteristics.
8. In the "Bus" menu, enable "Decode".

UART configuration settings



Figure 12-18: UART setup dialog

TX / RX / Source..... 217
 Polarity..... 217
 Threshold, Find Threshold..... 217
 Parity..... 218
 Stop Bits..... 218
 Bit Rate..... 218
 Data Size..... 218
 Idle Time..... 218

TX / RX / Source

Select the input channel of the UART lines. Input channels are the receive line (RX), and the optional transmit line (TX).

If the MSO option R&S RTB-B1 is installed, you can use logic channels as source.

Note: TX is available only on bus 1. On bus 2, you can set only one "Source" line. The TX line occupies a second bus line. Thus, if TX is used on bus 1, bus 2 is not available.

Remote command:

`BUS:UART:RX:SOURce = BUS:UART:DATA:SOURce` on page 460

`BUS:UART:TX:SOURce` on page 460

Polarity

Selects if the transmitted data is high active (high = 1) or low active (low = 1). The setting affects both lines.

High active is used, for example, for control signals, while low active is defined for data lines (RS-232).

Remote command:

`BUS:UART:DATA:POLarity` on page 460

`BUS:UART:POLarity` on page 460

Threshold, Find Threshold

Set the signal threshold for the source channel. Enter a value, or use "Find Threshold" to set the threshold to the middle reference level of the measured amplitude.

For analog channels, you can find the value also in the "Vertical" menu > "Channel <n>" > "Threshold"

For logic channels, you can find the value also in the "Logic" menu > "Threshold".

Remote command:

[CHANnel<m>:THReshold](#) on page 296

[CHANnel<m>:THReshold:FINDlevel](#) on page 297

[DIGital<m>:THReshold](#) on page 499

Parity

Defines the optional parity bit that is used for error detection.

"None"	No parity bit is used.
"Even"	The parity bit is set to "1" if the number of data bits set to "1" is odd. Adding the parity bit makes the data word's parity even.
"Odd"	The parity bit is set to "1" if the number of data bits set to "1" is even. Adding the parity bit makes the data word's parity odd.

Remote command:

[BUS:UART:PARity](#) on page 461

Stop Bits

Sets the number of stop bits: 1 or 1.5 or 2 stop bits are possible.

Remote command:

[BUS:UART:SBIT](#) on page 461

Bit Rate

Sets the number of transmitted bits per second.

"Predefined"	Selects from a list of predefined bit rates between 300 Bit/s and 1 MBit/s.
"User"	Specifies an individual bit rate with values between 150 and 39,062,500.

Remote command:

[BUS:UART:BAUDrate](#) on page 461

Data Size

Sets the number of data bits of a word in a range from 5 bits to 9 bits.

Remote command:

[BUS:UART:SSIZE](#) on page 461

Idle Time

Sets the minimal time between two data frames (packets), that is, between the last stop bit and the start bit of the next frame.

Remote command:

[BUS:UART:BITime](#) on page 462

12.4.3 UART Trigger

Before you set up the trigger, make sure that the bus is configured correctly. See [Chapter 12.4.2, "UART Configuration"](#), on page 216.

To trigger on UART signals:

1. Press the [Protocol] key in the Analysis area of the front panel.
2. Select the bus that is configured for UART.
3. Select "Trigger".

This selection has several effects:

- Enables decoding, if necessary.
- Sets the "Trigger Type" to "Serial Bus" and the trigger source to the selected bus.
- Displays the "UART Trigger" condition in the dialog box, below the protocol setup.

4. In the menu, select the "Source".
5. At "UART Trigger", select the required trigger condition:
 - "Start Bit" or "Frame Start": next start bit or first start bit after idle time
 - "Frame Start"
 - "Frame Error"
 - "Symbol <n>": frame number in a data stream
 - "Break": a start bit not followed by a stop bit
 - "Parity Error"
 - "Pattern": serial pattern of 1, 2, 3 or 4 symbols at a defined position in the data stream
 - "Any Symbol": pattern of data bits anywhere in a data stream
6. If "Pattern" or "Any Symbol" is selected, the UART trigger setup dialog expands to define the serial pattern or the symbol.

UART trigger settings

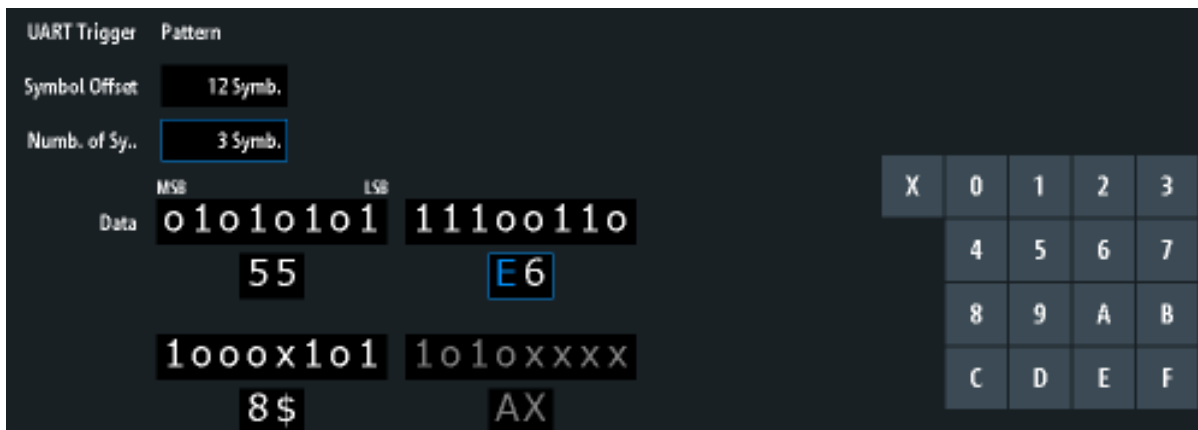

Figure 12-19: Trigger setup dialog with an example of a UART serial pattern

- 55 = Hex value of the 1st symbol, with the binary value 01010101
- E6 = Hex value of the 2nd symbol, with the binary value 11100110
- E (blue) = Selected nibble in the 2nd symbol. The blue color indicates that the keypad is active for this nibble.
- 8\$ = Hex value of the 3rd symbol, where the 1st nibble has the binary value 1000 and the 2nd nibble is represented by the "\$" character, as it includes one "X" bit (don't care)
- AX (gray) = The 4th symbol is not contained in the specified pattern

Source.....220

UART Trigger..... 220

Symbol Offset.....221

Numb. of Symb..... 221

Data.....221

Source

Selects the transmitter or receiver line as trigger source.

Remote command:

TRIGger:A:SOURce:UART on page 462

UART Trigger

Selects the trigger condition.

- "Start Bit" Sets the trigger to the start bit. The start bit is the first logical 0 after a stop bit.
- "Frame Start" Sets the trigger to the beginning of a frame. The frame start is the first start bit after the idle time.
- "Frame Error" The instrument triggers, if a frame error occurs.
- "Symbol <n>" Sets the trigger to the specified symbol - the n-th word - in a frame (package). Specify the "Symbol Offset" on page 221.
- "Break" Triggers if a start bit is not followed by a stop bit, the data line remains at logic 0 for longer than a UART word.
- "Parity Error" Triggers on a parity error indicating a transmission error.

- "Pattern" Triggers on a data pattern at a specified position. The pattern setup consists of the "Symbol Offset" on page 221, the "Numb. of Symb." on page 221, and the "Data" on page 221.
- "Any Symbol" Triggers on a pattern that occurs in one symbol at any position in a frame.
See "Data" on page 221.

Remote command:

`TRIGger:A:UART:MODE` on page 462

Symbol Offset

Sets the number of symbols at the beginning of the package to be ignored before the serial pattern. The first symbol of interest is the first byte after the offset symbols.

The minimum offset is 0 symbols, the maximum offset is 4,095 symbols.

Remote command:

`TRIGger:A:UART:POFFset` on page 463

Numb. of Symb.

Sets the number of symbols (full bytes) you want to trigger on. The minimum is 1 symbol, a maximum of 4 symbols is possible.

Note: Entering data bits beyond the specified length of the pattern automatically adjusts the "Number of Bytes" to include all specified bytes.

Remote command:

`TRIGger:A:UART:PLENght` on page 463

Data

Specifies the data pattern if "UART Trigger" is set to "Pattern" or "Any Symbol".

An example of pattern definition is shown in [Figure 12-19](#).

To enter the binary value of any bit, tap this bit. To enter the hexadecimal value, tap one of the nibbles (half byte) in the lower data line.

If a nibble (half byte) contains 1, 2 or 3 "X" bits (don't care), the nibble value is represented by the character "\$". If all 4 bits of a nibble are "X", the nibble itself is "don't care", represented by the character "X".

Remote command:

`TRIGger:A:UART:PATtern` on page 463

12.4.4 UART Decode Results

When the configuration of the serial bus is complete, the signal can be decoded:

1. In the "Bus" menu, enable "Decode".
2. In the "Display" menu, select the result display settings.
See [Chapter 12.1.2, "Displaying Decode Results"](#), on page 191.
3. In the "Bus Table" menu, enable the "Bus Table". Adjust the table settings.
See also: [Chapter 12.1.3, "Bus Table: Decode Results"](#), on page 192

The instrument captures and decodes the signal according to the protocol definition and the configuration settings.

The color-coding of the various protocol sections and errors simplifies the interpretation of the visual display. The decode information condenses or expands, depending on the horizontal scale. Various data formats are available to show the result values.



Figure 12-20: Decoded UART signal

The figure above shows six frames of a UART signal and the "Bus Table".

Table 12-3: Content of the UART frame table

Column	Description
Start time	Time of the frame start in relation to the trigger point
Data	Hexadecimal values of the data words
State	Overall state of the frame

Remote commands are described in [Chapter 15.11.4.3, "UART - Decode Results"](#), on page 464.

12.5 CAN (Option R&S RTB-K3)

CAN is the Controller Area Network, a bus system designed by Bosch for use within automotive network architecture, for example, for brake, power train and engine management. Today, it is also used in many other systems, for example, in industrial machines, aerospace, subsea, merchant marine.

• The CAN Protocol	223
• CAN Configuration	224
• CAN Trigger	226
• CAN Decode Results	230
• Search on Decoded CAN Data	232
• CAN Label List	234

12.5.1 The CAN Protocol

This chapter provides an overview of the protocol characteristics, frame types, information transfer and message formats.

The CAN 2.0 specification defines two formats: the base CAN (version 2.0A) with an 11-bit identifier and the extended CAN (version 2.0B) with a 29-bit identifier. Based on these specifications the CAN standard ISO 11898-1 was released, in 1993.

CAN characteristics

Main characteristics of CAN are:

- Differential signaling.
- Transmission over two wires, high and low.
- Multi-master, which means that any node can begin to transmit a message, when a bus is free.
- Bitwise arbitration.

Arbitration

Information transfer is done by carrier sense multiple access/bitwise arbitration (CSMA/BA). Each node waits for a certain inactive period before it tries to send a message. Collisions are resolved through a bitwise arbitration that is non-destructive.

Each message has a priority which is implied in the identifier value - the lower the value, the higher the priority. A dominant bit from the message with highest priority overwrites the recessive bits on the bus. If a node detects that the bus is already receiving a message that has a higher priority, it stops the transmission and waits for the current transmission to end before retransmitting.

Frame types

The CAN protocol defines the following types of frames:

- Data: used for information transmission.
- Remote: used for information request. The destination node sends this frame to the source to request data. This type of frame is only used by CAN.
- Error: indicates that a bus node has detected transmission error.
- Overload: used from a bus node to request a transmission delay.

CAN data message format

The CAN protocol defines two formats for the data frame: the base frame format and the extended frame format. The data frames are built as follows:



Figure 12-21: CAN basic frame

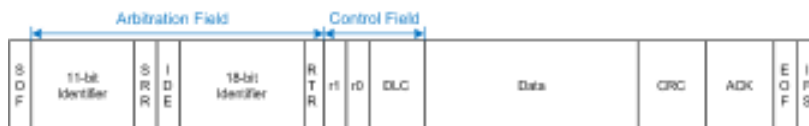

Figure 12-22: CAN extended frame

The following fields, compose the base/extended frame format:

- **SO****F**: start of frame. 1 dominant bit that marks the beginning of the message.
- **Identifier**: 11/18-bit identifier. Contains information about the priority of the message. CAN base frames have an 11-bit identifier while CAN extended frames have a total of 29 bits identifier.
- **RTR**: remote transmission request bit. Differentiates between base and extended frames. It is dominant for base data frames and recessive for extended data frames.
- **SRR**: substitute remote request. Only present in extended CAN frames at the position of the RTR bit in base frames.
- **IDE**: identifier extension bit. It helps to distinguish between a base and extended data frame. It is dominant for data frames and recessive for remote frames
- **r0/r1**: reserved bits for possible future use.
- **DLC**: data length code. Defines how many bytes of data follow.
- **Data**: up to 8 bytes of data can be transmitted for CAN.
- **CRC**: cyclic redundancy check. Checks the integrity of the frame contents.
- **ACK**: acknowledgement. This is a recessive bit that is overwritten by the node, if the message was transmitted correctly.
- **EOF**: end-of-frame: marks the end of the message.
- **IFS**: interframe space. Separates a data or remote frame from the preceding frames.

12.5.2 CAN Configuration

The correct setup of the protocol parameters and the threshold is the condition for decoding the signal.

To set up and decode a CAN signal

1. Press the [Protocol] key in the Analysis area of the front panel.
2. Select the bus that you want to use: B1 or B2.
3. Select the "Bus Type" = CAN.
4. Select "Configuration".
5. Select the "Source", the channel to which the input signal is connected.
6. Set the threshold. Use one of the following methods:
 - Tap "Find Threshold". The instrument evaluates the signal and sets the threshold.
 - Enter the threshold value in the numeric field.
7. Set the other signal parameters according to the signal characteristics. All settings are described below.
8. In the "Bus" menu, enable "Decode".

CAN configuration settings

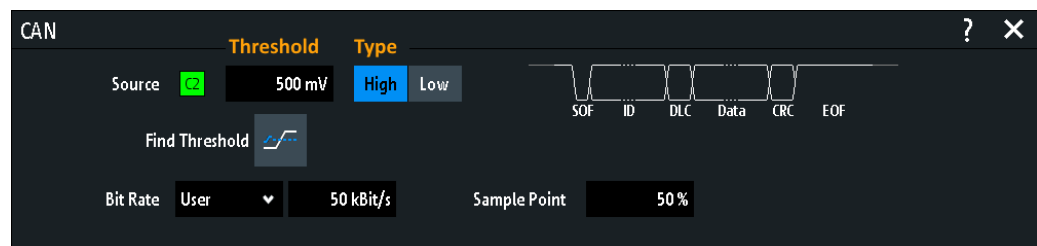

Source.....	225
Threshold, Find Threshold.....	225
Type.....	226
Bit Rate.....	226
Sample Point.....	226

Source

Sets the source of the data line. All channel waveforms can be used.

If the MSO option R&S RTB-B1 is installed, you can use logic channels as source.

Remote command:

[BUS : CAN : DATA : SOURce](#) on page 469

Threshold, Find Threshold

Set the signal threshold for the source channel. Enter a value, or use "Find Threshold" to set the threshold to the middle reference level of the measured amplitude.

For analog channels, you can find the value also in the "Vertical" menu > "Channel <n>" >"Threshold"

For logic channels, you can find the value also in the "Logic" menu > "Threshold".

Remote command:

[CHANnel<m>:THReshold](#) on page 296

[CHANnel<m>:THReshold:FINDlevel](#) on page 297

[DIGital<m>:THReshold](#) on page 499

Type

Selects the CAN-High or CAN-Low line. CAN uses both lines for differential signal transmission.

If you measure with a differential probe, connect the probe to both CAN-H and CAN-L lines and select "High".

If you use a single-ended probe, connect the probe to either CAN_L or CAN_H and select "High" or "Low" accordingly.

Remote command:

[BUS:CAN:TYPE](#) on page 469

Bit Rate

Sets the number of transmitted bits per second. The maximum bit rate for High Speed CAN is 1 Mbit/s. The bit rate is uniform and fixed for a given CAN bus.

"Predefined" To select a bit rate from the list of predefined values, set "Bit rate" to "Predefined" and select a value from the list.

"User" To set another value, set "Bit rate" to "User" and enter a bit/s value.

Remote command:

[BUS:CAN:BITRate](#) on page 470

Sample Point

Sets the position of the sample point within the bit in percent of the nominal bit time. The sample point divides the nominal bit period into two distinct time segments, which are used for resynchronization of the clock.

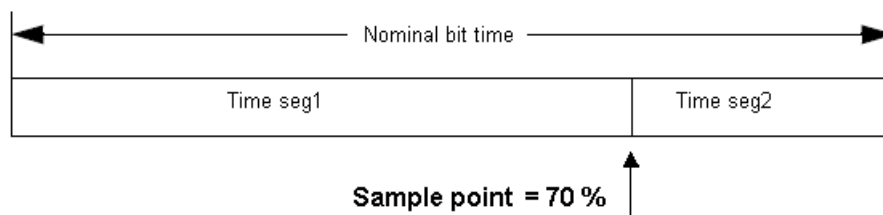

The CAN bus interface uses an asynchronous transmission scheme. The standard specifies a set of rules to resynchronize the local clock of a CAN node to the message.

Remote command:

[BUS:CAN:SAMPlepoint](#) on page 470

12.5.3 CAN Trigger

Before you set up the trigger, make sure that the bus is configured correctly. See [Chapter 12.5.2, "CAN Configuration"](#), on page 224.

To trigger on CAN signals:

1. Press the [Protocol] key in the Analysis area of the front panel.
2. Select the bus that is configured for CAN.
3. Select "Trigger".

This selection has several effects:

- Enables decoding, if necessary.
- Sets the "Trigger Type" to "Serial Bus" and the trigger source to the selected bus.
- Displays the "CAN Trigger" condition in the dialog box, below the protocol setup.

4. At "CAN Trigger", select the required trigger type:
 - "Start of Frame": first edge of synchronization bit
 - "End of Frame": frame number in a data stream
 - "Frame": error, overload, data or remote frame
 - "Error": stuff bit, form, acknowledgment, CRC
 - "Identifier": specific message identifier or identifier range
 - "Identifier and Data": combination of identifier and data condition
5. If "Identifier" or "Identifier and Data" is selected, the CAN trigger setup dialog expands to define the serial pattern.

CAN trigger settings

Figure 12-23: Trigger setup dialog with an example of CAN identifier and data patterns

"CAN Trigger" = trigger on "Identifier and Data"

"Identifier" = trigger on 29-bit identifiers greater than the specified identifier

"Data" = trigger on the specified 6-byte data pattern

0 (blue) = Selected nibble in the 2nd byte of the data pattern, where the blue color indicates that the keypad is active for this nibble

CAN Trigger

Selects the trigger mode.

"Start of Frame" Triggers on the first edge of the dominant SOF bit (synchronization bit).

"End of Frame"	Triggers on the end of the frame (7 recessive bits).
"Frame"	Triggers on the frame type that is selected with "Frame" See: "Frame" on page 228.
"Error"	Triggers on a frame error. An error frame is sent by a node that has detected an error. See: "Error" on page 228.
"Identifier"	Triggers on a specific message identifier or an identifier range. If a label list with node names was loaded and applied in the bus configuration, you can select simply the "Symbolic ID" instead of entering the numeric identifier. See: "Identifier condition" on page 229.
"Identifier and Data"	Triggers on a combination of identifier and data condition. The instrument triggers at the end of the last byte of the specified data pattern. See: "Identifier condition" on page 229 and "Data condition" on page 230.

Remote command:

[TRIGger:A:CAN:TYPE](#) on page 471

Frame

Select the frame type to be triggered on.

"Data"	Frame for data transmission. The identifier format ("ID Type") is also considered.
"Remote"	A remote frame initiates the transmission of data by another node. The frame format is the same as of data frames, but without the data field. The identifier format ("ID Type") is also considered.
"Data or Remote"	Triggers on remote frames and on data frames. The identifier format ("ID Type") is also considered.
"Error"	Triggers on any error frame.
"Overload"	An overload frame is sent by a node that needs a delay between data and/or remote frames.

Remote command:

[TRIGger:A:CAN:FTYPE](#) on page 471

ID Type

Selects the length of the identifier: 11 bit for CAN base frames or 29 bits for CAN extended frames. Select "Any" if the identifier type is not relevant.

Remote command:

[TRIGger:A:CAN:ITYPe](#) on page 471

Error

Identifies various errors in the frame. You can select one or more error types as trigger condition.

Remote command:

[TRIGger:A:CAN:TYPE](#) on page 471

Stuff Bit ← Error

The following frame segments are coded by the bit stuffing method:

- Start of frame
- Arbitration field
- Control field
- Data field
- CRC sequence

The transmitter automatically inserts a complementary bit into the bitstream when it detects five consecutive bits of identical value in the bitstream to be transmitted. A stuff error occurs when the 6th consecutive equal bit level in the mentioned fields is detected.

Remote command:

[TRIGger:A:CAN:BITSterror](#) on page 473

Form ← Error

A form error occurs when a fixed-form bit field contains one or more illegal bits.

Remote command:

[TRIGger:A:CAN:FORMerror](#) on page 474

Acknowledge ← Error

An acknowledgment error occurs when the transmitter does not receive an acknowledgment - a dominant bit during the "Ack" slot.

Remote command:

[TRIGger:A:CAN:ACKerror](#) on page 473

CRC ← Error

CAN uses the Cyclic Redundancy Check (CRC), which is a complex checksum calculation method. The transmitter calculates the CRC and sends the result in the CRC sequence. The receiver calculates the CRC in the same way. A CRC error occurs when the calculated result differs from the received value in the CRC sequence.

Remote command:

[TRIGger:A:CAN:CRCErrror](#) on page 473

Identifier condition

The identifier condition consists of the following settings:

- [ID Type](#)
- Comparison
- Identifier value

Compare ← Identifier condition

Sets the identifier comparison condition: If the identifier pattern contains at least one X (do not care), you can trigger on values equal or not equal to the specified value. If the pattern contains only 0 and 1, you can also trigger on a range greater than or lower than the specified value.

Remote command:

[TRIGger:A:CAN:ICONdition](#) on page 472

Bin / Hex pattern ← Identifier condition

Defines the identifier or data pattern in binary and hexadecimal format. To set an individual binary bit or hex nibble (half byte), tap it and enter it via the on-screen keypad.

"Bin"	String containing the binary pattern with a maximum of 64 bits. Characters 0, 1 and X are allowed.
"Hex"	String containing the hexadecimal pattern with a maximum of 8 bytes. Characters 0 to F and X are allowed.

Remote command:

[TRIGger:A:CAN:IDENTifier](#) on page 472

[TRIGger:A:CAN:DATA](#) on page 473

Symbolic ID ← Identifier condition

If a label list with symbolic names was loaded and applied in the bus configuration, you can select a symbolic name from the list instead of entering the numeric identifier. The instrument triggers on the identifier of the selected node.

Data condition

The data condition consists of the following settings:

- Length of the data pattern
- Comparison
- Data pattern, see ["Bin / Hex pattern"](#) on page 230

Data ← Data condition

Defines the length of the data pattern - the number of bytes in the pattern.

Remote command:

[TRIGger:A:CAN:DLC](#) on page 472

Compare ← Data condition

Sets the data comparison condition. If the pattern contains at least one X (do not care), you can trigger on values equal or not equal to the specified value. If the pattern contains only 0 and 1, you can also trigger on a range greater than or lower than the specified value.

Remote command:

[TRIGger:A:CAN:DCondition](#) on page 472

12.5.4 CAN Decode Results

When the configuration of the serial bus is complete, the signal can be decoded:

1. In the "Bus" menu, enable "Decode".
2. In the "Display" menu, select the result display settings.
See [Chapter 12.1.2, "Displaying Decode Results"](#), on page 191.
3. In the "Bus Table" menu, enable the "Bus Table". Adjust the table settings.
See also: [Chapter 12.1.3, "Bus Table: Decode Results"](#), on page 192

The instrument captures and decodes the signal according to the protocol definition and the configuration settings.

The color-coding of the various protocol sections and errors simplifies the interpretation of the visual display. The decode information condenses or expands, depending on the horizontal scale. Various data formats are available to show the result values.

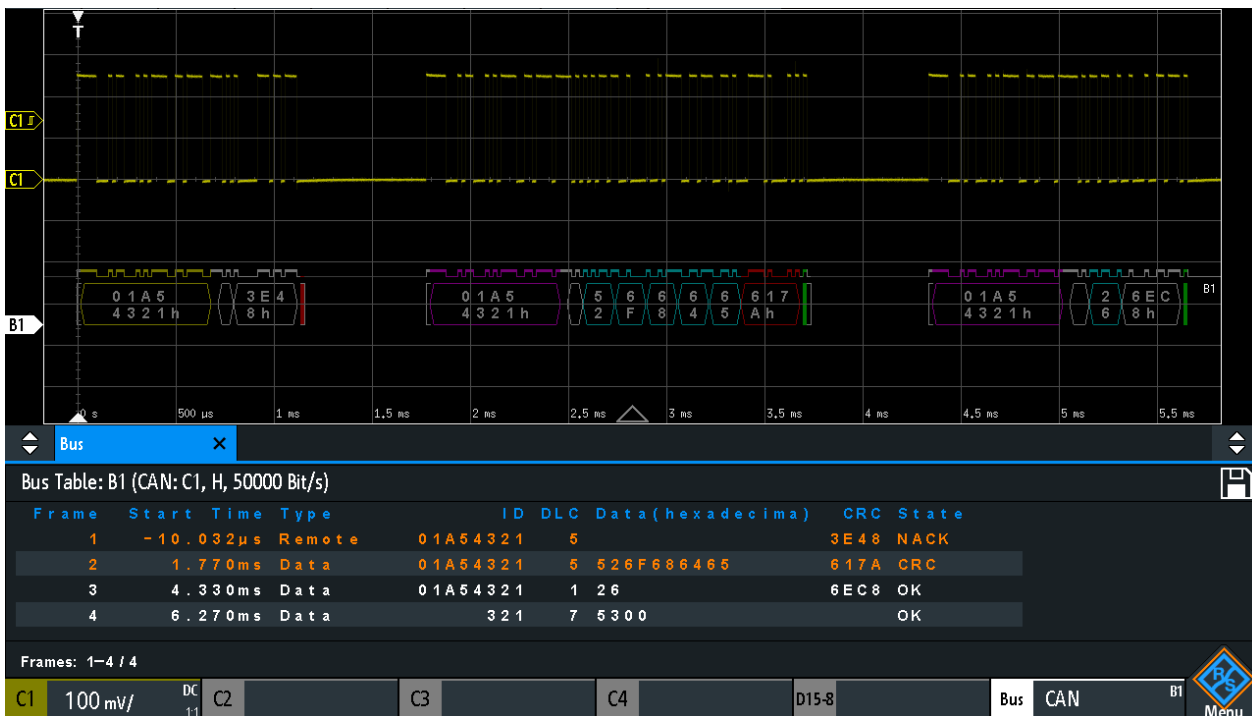

Figure 12-24: Decoded CAN signal with bus table, trigger on frame start

- violet = identifier
- gray = DLC, data length code
- blue = data words
- red = error occurred, error frame

The figure above shows a decoded CAN signal and the "Bus Table".

Table 12-4: Content of the CAN frame table

Column	Description
Time Diff.	Time of frame start in relation to the trigger point
Type	Frame type: Data, Remote, Error, or Overload
ID	Identifier value, hexadecimal value
DLC	Data length code, number of data bytes
Data	Hexadecimal values of the data bytes
CRC	Hexadecimal value of the Cyclic Redundance Check (checksum)
State	Overall state of the frame.

Remote commands are described in [Chapter 15.11.5.3, "CAN - Decode Results"](#), on page 474.

12.5.5 Search on Decoded CAN Data

Using the search functionality, you can find the same events in the decoded data which you also can trigger on. Unlike trigger, the search finds all events in an acquisition that fulfill the search condition. The results are listed in a table and can be saved to file.



Figure 12-25: Search on a CAN bus for data frames with 29-bit ID

To search for events in a CAN signal

1. Configure and decode the bus correctly.
2. Acquire decoded data.
3. Press the Search key.
4. Select the "Search Type" = "Protocol".
5. Select the "Source": the bus that is configured for CAN protocol.
6. Select the "Event" you want to search for.
7. Enter additional settings, depending on the event.

CAN search settings



Figure 12-26: Settings for search on CAN bus for frames with identifier 567 (hex) that have an error

Event

Sets the event or combination of events to be searched for. For example, you can search for frames, errors, data, or IDs. Depending on the selected event, additional settings are displayed.

Remote command:

[SEARCH:PROTOCOL:CAN:CONDITION](#) on page 480

Frame Setup

Selects the frame type to be searched for.

If you search for remote or data frames, the search considers also the ID type, the length of the identifier. The setting is only available if "Event" = "Frame" is selected.

Remote command:

[SEARCH:PROTOCOL:CAN:FRAME](#) on page 481

Error

Selects the error type to be searched for. You can select one or more error types as search condition. The error types are the same as in the CAN trigger setup, see [Chapter 12.5.3, "CAN Trigger"](#), on page 226.

The setting is only available if "Event" = "Error" or "Error & ID" is selected.

Remote command:

[SEARCH:PROTOCOL:CAN:ACKERROR](#) on page 481

[SEARCH:PROTOCOL:CAN:BITSTERROR](#) on page 482

[SEARCH:PROTOCOL:CAN:CRCEERROR](#) on page 482

[SEARCH:PROTOCOL:CAN:FORMERROR](#) on page 482

Frame Type

Selects the frame type to be searched for, if "Event" = "Identifier" is selected. You can search for data and/or remote frames.

Remote command:

[SEARCH:PROTOCOL:CAN:FTYPE](#) on page 482

Identifier condition

Settings to define the identifier pattern, if "Event" = "Identifier" or "Id & Error" or "Id & Data" is selected.

After setting the "ID Type" and the "Compare" condition, you can enter the identifier value by setting the state high, low, or X (do not care) for each single bit. Alternatively, you can enter a hexadecimal value for each half byte. The settings are the same as for the setup of the identifier trigger, see also "[Identifier condition](#)" on page 229.

If a label list with node names was loaded and applied in the bus configuration, you can select the node name from the list instead of entering the numeric identifier. The instrument triggers on the identifier of the selected node.

Remote command:

[SEARCH:PROTOCOL:CAN:ITYPE](#) on page 482

[SEARCH:PROTOCOL:CAN:ICONDITION](#) on page 483

[SEARCH:PROTOCOL:CAN:IDENTIFIER](#) on page 483

Data condition

Settings to define the data pattern to be searched, if "Event" = "Id & Error" is selected.

After setting the "Data" length and the "Compare" condition, you can enter the data value by setting the state high, low, or X (do not care) for each single bit. Alternatively, you can enter a hexadecimal value for each half byte. The settings are the same as for the setup of the data trigger, see also "[Data condition](#)" on page 230.

Remote command:

[SEARCH:PROTOCOL:CAN:DLENGTH](#) on page 483

[SEARCH:PROTOCOL:CAN:DCONDITION](#) on page 483

[SEARCH:PROTOCOL:CAN:DATA](#) on page 484

12.5.6 CAN Label List

For general information on label lists and how to trigger on symbolic IDs, see [Chapter 12.1.5, "Label List"](#), on page 195.

Label list files are protocol-specific. A PTT label file for CAN protocols contains three values for each identifier:

- Identifier type, 11-bit or 29-bit long
- Identifier value
- Label, symbolic name of the identifier, specifying its function in the bus network.

Example: CAN PTT file

```
# -----
@FILE_VERSION = 1.00
```

```

@PROTOCOL_NAME = can
# -----
# Labels for CAN protocol
#   Column order: Identifier type, Identifier value, Label
# -----
11,064h,Diag_Response
11,1E5h,EngineData
11,0A2h,Ignition_Info
11,1BCh,TP_Console
11,333h,ABSdata
11,313h,Door_Left
11,314h,Door_Right
29,01A54321h,Throttle
29,13A00FA2h,LightState
29,0630ABCDh,Engine_Status
29,03B1C002h,Airbag_Status
29,01234ABCh,NM_Gateway
# -----

```

Label List: CAN (Imported on: 2017-03-30; 15:10)	
Symbolic Label	ID / Addr
ABSdata	0x333
Airbag_Status	0x03B1 C002
Diag_Response	0x064
Door_Left	0x313
Door_Right	0x314
Engine_Status	0x0630 ABCD
EngineData	0x1E5
Ignition_Info	0x0A2
LightState	0x13A0 0FA2
NM_Gateway	0x0123 4ABC
Throttle	0x01A5 4321

Figure 12-27: Label list for CAN

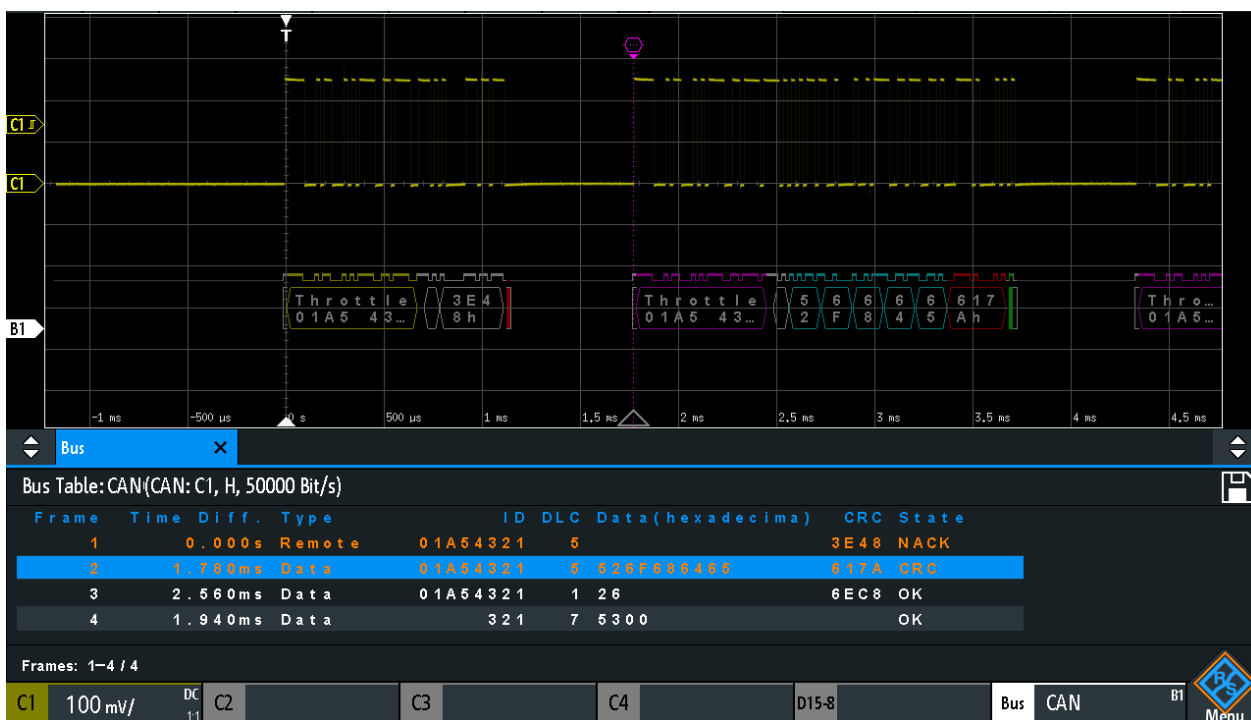

Figure 12-28: Decoded CAN signal with bus table and applied label list

12.6 LIN (Option R&S RTB-K3)

The Local Interconnect Network (LIN) is a simple, low-cost bus system used within automotive network architectures. LIN is usually a sub-network of a CAN bus. The primary purpose of LIN is the integration of uncritical sensors and actuators with low bandwidth requirements. Common applications in a motor vehicle are the control of doors, windows, wing mirrors, and wipers.

- [The LIN Protocol](#)..... 236
- [LIN Configuration](#)..... 238
- [LIN Trigger](#)..... 240
- [LIN Decode Results](#) 243
- [Search on Decoded LIN Data](#)..... 244
- [LIN Label List](#)..... 247

12.6.1 The LIN Protocol

This chapter provides an overview of protocol characteristics, frame format, identifiers and trigger possibilities. For detailed information, order the LIN specification on <http://www.lin-subbus.org/> (free of charge).

LIN characteristics

Main characteristics of LIN are:

- Single-wire serial communications protocol, based on the UART byte-word interface
- Single master, multiple slaves - usually up to 12 nodes
- Master-controlled communication: master coordinates communication with the LIN schedule and sends identifier to the slaves
- Synchronization mechanism for clock recovery by slave nodes without crystal or ceramics resonator

The R&S RTB2000 supports several versions of the LIN standard: v1.3, v2.0, v2.1 and the American SAE J2602.

Data transfer

Basic communication concept of LIN:

- Communication in an active LIN network is always initiated by the master.
- Master sends a message header including the synchronization break, the synchronization byte, and the message identifier.
- The identified node sends the message response: one to eight data bytes and one checksum byte.
- Header and response form the message frame.

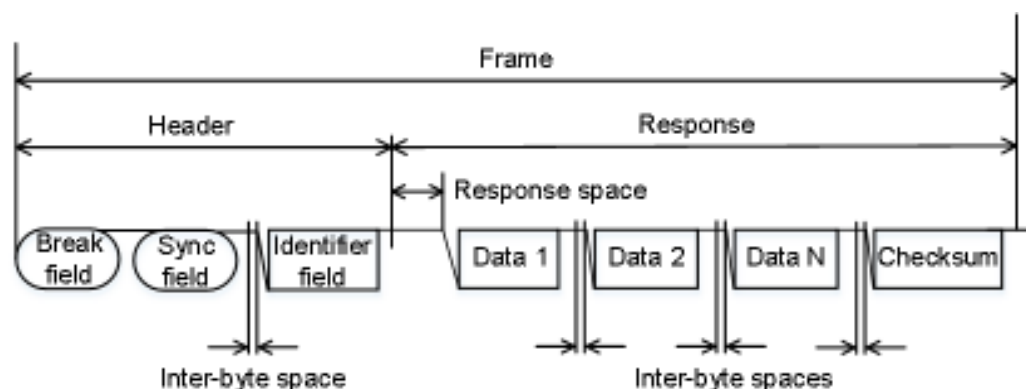

Figure 12-29: LIN frame with header and response

The data is transmitted in bytes using the UART byte-word interface without the parity bit. Each byte consists of a start bit, 8 bits and a stop bit.

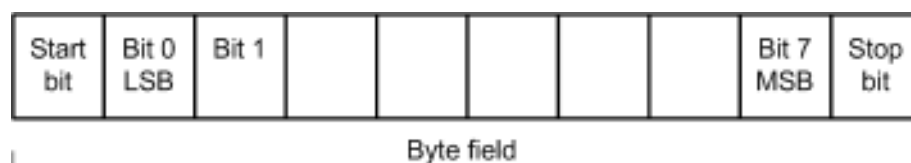

Figure 12-30: Structure of a byte field

Data bytes are transmitted LSB first.

The identifier byte consists of 6 bits for the frame identifier and two parity bits. This combination is known as protected identifier.

Trigger

The R&S RTB2000 can trigger on various parts of LIN frames. The data line must be connected to an input channel, triggering on math and reference waveforms is not possible.

You can trigger on:

- Frame start (synchronization field)
- Specific slave identifier or identifier range
- Data pattern in the message
- Wake up signal
- Checksum error (error in data), parity error (error in identifier)

12.6.2 LIN Configuration

The correct setup of the protocol parameters and the threshold is the condition for decoding the signal.

To set up and decode a LIN signal

1. Press the [Protocol] key in the Analysis area of the front panel.
2. Select the bus that you want to use: B1 or B2.
3. Select the "Bus Type" = LIN.
4. Select "Configuration".
5. Select the "Source", the channel to which the input signal is connected.
6. Set the threshold:
 - Tap "Find Threshold". The instrument evaluates the signal and sets the threshold.
 - Enter the threshold value in the numeric field.
7. Set the other signal parameters according to the signal characteristics. All settings are described below.
8. In the "Bus" menu, enable "Decode".

LIN Configuration Settings



Figure 12-31: LIN setup dialog

Source.....	239
Idle.....	239
Threshold, Find Threshold.....	239
Version.....	239
Bit Rate.....	240

Source

Sets the source of the data line. All channel waveforms can be used.

If the MSO option R&S RTB-B1 is installed, you can use logic channels as source.

Remote command:

[BUS:LIN:DATA:SOURce](#) on page 484

Idle

Defines the idle state of the bus. The idle state is the recessive state and corresponds to a logic 1.

Remote command:

[BUS:LIN:POLarity](#) on page 485

Threshold, Find Threshold

Set the signal threshold for the source channel. Enter a value, or use "Find Threshold" to set the threshold to the middle reference level of the measured amplitude.

For analog channels, you can find the value also in the "Vertical" menu > "Channel <n>" > "Threshold"

For logic channels, you can find the value also in the "Logic" menu > "Threshold".

Remote command:

[CHANnel<m>:THReshold](#) on page 296

[CHANnel<m>:THReshold:FINDlevel](#) on page 297

[DIGital<m>:THReshold](#) on page 499

Version

Selects the version of the LIN standard that is used in the DUT. The setting mainly defines the checksum version used during decoding.

The most common version is LIN 2.x. For mixed networks, or if the standard is unknown, set the LIN standard to "Any".

Remote command:

[BUS:LIN:STANdard](#) on page 485

Bit Rate

Sets the number of transmitted bits per second. The LIN standard defines a maximum bit rate of 20 kbit/s.

"Predefined" To select a bit rate from the list of predefined values, set "Bit Rate" to "Predefined" and select a value from the list.

"User" To set another value, set "Bit Rate" to "User" and enter a bit/s value.

Remote command:

[BUS:LIN:BITRate](#) on page 485

12.6.3 LIN Trigger

Before you set up the trigger, make sure that the bus is configured correctly. See [Chapter 12.6.2, "LIN Configuration"](#), on page 238.

To trigger on LIN signals:

1. Press the [Protocol] key in the Analysis area of the front panel.
2. Select the bus that is configured for LIN.
3. Select "Trigger".

This selection has several effects:

- Enables decoding, if necessary.
- Sets the "Trigger Type" to "Serial Bus" and the trigger source to the selected bus.
- Displays the "LIN Trigger" condition in the dialog box, below the protocol setup.

4. At "LIN Trigger", select the required trigger type:
 - "Start of Frame": stop bit of the sync field
 - "Wake Up": after a wakeup frame
 - "Error": checksum, parity or synchronization
 - "Identifier": specific message identifier or identifier range
 - "Identifier and Data": combination of identifier and data condition
5. If "Identifier" or "Identifier and Data" is selected, the LIN trigger setup dialog expands to define the serial pattern.

LIN Trigger Settings

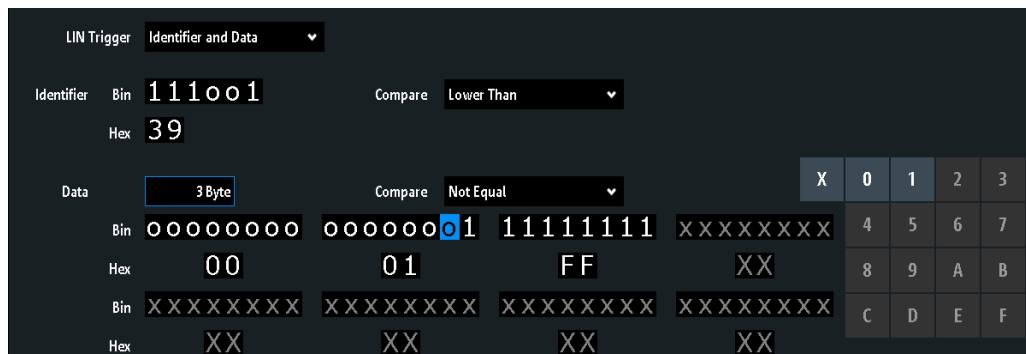

Figure 12-32: Trigger setup to trigger on identifier and data patterns

o (blue) = Selected bit in the 2nd byte of the data pattern, where the blue color indicates that the keypad is active for this bit

- LIN Trigger..... 241
- Error..... 242
 - L Checksum..... 242
 - L Parity..... 242
 - L Synchronization..... 242
- Identifier condition..... 242
 - L Identifier..... 242
 - L Compare..... 242
 - L Symbolic ID..... 243
- Data condition..... 243
 - L Data..... 243
 - L Compare..... 243
 - L Bin / Hex..... 243

LIN Trigger

Selects the trigger mode.

- "Start of Frame" Triggers on the stop bit of the synchronization field.
- "Wake Up" Triggers after a wakeup frame.
- "Error" Identifies various errors in the frame. You can select one or more error types as trigger condition. See "Error" on page 242.
- "Identifier" Sets the trigger to a specific message identifier or an identifier range. Only the 6 bit identifier without parity bits is considered, not the protected identifier. See "Identifier condition" on page 242.
- "Identifier and Data" Triggers on a combination of identifier and data condition. The instrument triggers at the end of the last byte of the specified data pattern. An example is shown in Figure 12-32. See "Identifier condition" on page 242 and "Data condition" on page 243.

Remote command:

[TRIGger:A:LIN:TYPE](#) on page 486

Error

Select one or more error types as trigger condition.

Checksum ← Error

Checksum error. The checksum verifies the correct data transmission. It is the last byte of the frame response. The checksum includes not only the data but also the protected identifier (PID).

Remote command:

[TRIGger:A:LIN:CHKSError](#) on page 486

Parity ← Error

Parity error. Parity bits are the bits 6 and 7 of the identifier. They verify the correct transmission of the identifier.

Remote command:

[TRIGger:A:LIN:IPERror](#) on page 487

Synchronization ← Error

Error during synchronization.

Remote command:

[TRIGger:A:LIN:SYERror](#) on page 487

Identifier condition

The identifier condition consists of the following settings:

- Identifier value
- Comparison

Identifier ← Identifier condition

Defines the identifier pattern in binary and hexadecimal format. To set an individual binary bit or hex nibble (half byte), tap it and enter it via the on-screen keypad.

"Bin" String containing the binary pattern with a maximum of 64 bits. Characters 0, 1 and X are allowed.

"Hex" String containing the hexadecimal pattern with a maximum of 8 bytes. Characters 0 to F and X are allowed.

Remote command:

[TRIGger:A:LIN:IDENTifier](#) on page 487

Compare ← Identifier condition

Sets the identifier comparison condition: If the identifier pattern contains at least one X (don't care), you can trigger on values equal or not equal to the specified value. If the pattern contains only 0 and 1, you can also trigger on a range greater than or lower than the specified value.

Remote command:

[TRIGger:A:LIN:ICONdition](#) on page 487

Symbolic ID ← Identifier condition

If a label list with symbolic names was loaded and applied in the bus configuration, you can select a symbolic name from the list instead of entering the numeric identifier. The instrument triggers on the identifier of the selected node.

Data condition

The data condition consists of the following settings:

- Length of the data pattern
- Comparison
- Data pattern

Data ← Data condition

Defines the length of the data pattern - the number of bytes in the pattern.

Remote command:

[TRIGger:A:LIN:DLENgth](#) on page 488

Compare ← Data condition

Sets the comparison condition: If the pattern contains at least one X (don't care), you can trigger on values equal or not equal to the specified value. If the pattern contains only 0 and 1, you can also trigger on a range greater than or lower than the specified value.

Remote command:

[TRIGger:A:LIN:DCONdition](#) on page 488

Bin / Hex ← Data condition

Specifies the data pattern to be triggered. To set an individual binary bit or hexadecimal nibble (half byte), tap it and enter it via the on-screen keypad. Make sure to specify complete bytes.

"Bin" String containing the binary pattern with a maximum of 64 bits. Characters 0, 1 and X are allowed.

"Hex" String containing the hexadecimal pattern with a maximum of 8 bytes. Characters 0 to F and X are allowed.

Remote command:

[TRIGger:A:LIN:DATA](#) on page 487

12.6.4 LIN Decode Results

When the configuration of the serial bus is complete, the signal can be decoded:

1. In the "Bus" menu, enable "Decode".
2. In the "Display" menu, select the result display settings.
See [Chapter 12.1.2, "Displaying Decode Results"](#), on page 191.
3. In the "Bus Table" menu, enable the "Bus Table". Adjust the table settings.
See also: [Chapter 12.1.3, "Bus Table: Decode Results"](#), on page 192

The instrument captures and decodes the signal according to the protocol definition and the configuration settings.

The color-coding of the various protocol sections and errors simplifies the interpretation of the visual display. The decode information condenses or expands, depending on the horizontal scale. Various data formats are available to show the result values.

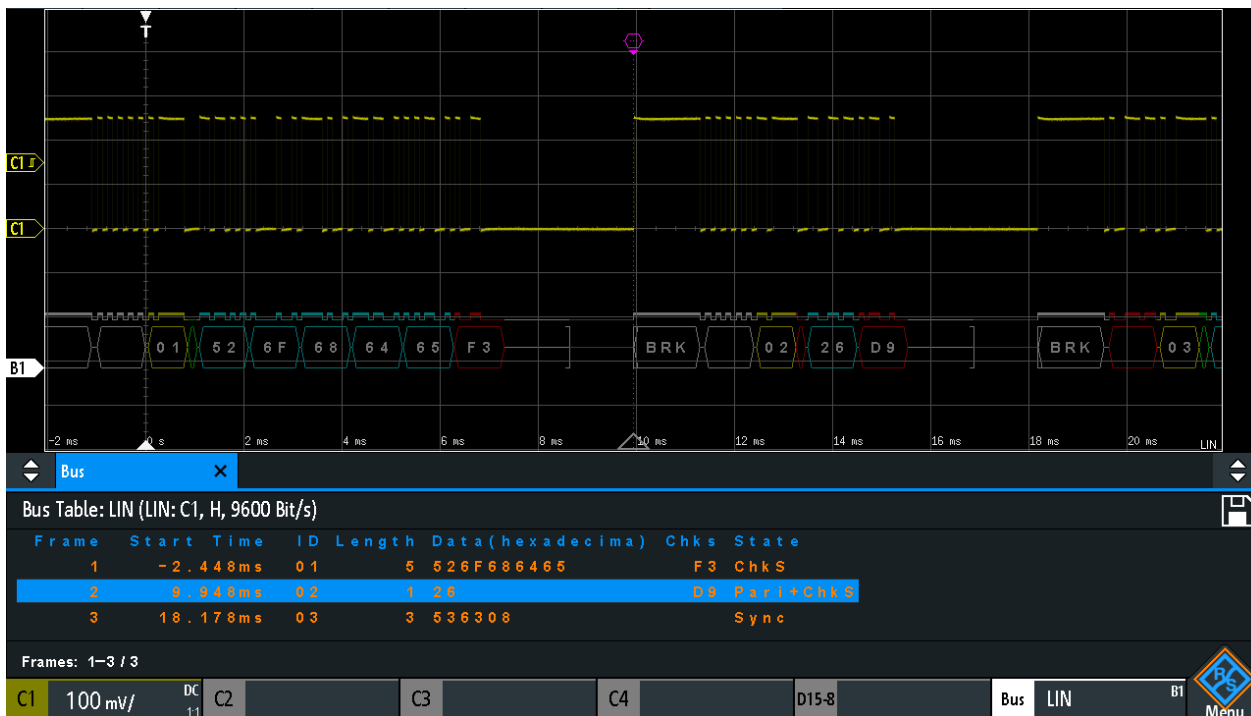

Figure 12-33: Decoded LIN signal with bus table, trigger on frame start

Table 12-5: Content of the LIN frame table

Column	Description
Start time	Time of frame start in relation to the trigger point
ID	Identifier value, hexadecimal value
Length	Number of data bytes
Data	Hexadecimal values of the data bytes
Chks	Checksum value
State	Overall state of the frame.

Remote commands are described in [Chapter 15.11.6.3, "LIN - Decode Results"](#), on page 488.

12.6.5 Search on Decoded LIN Data

Using the search functionality, you can find the same events in the decoded data which you also can trigger on. Unlike trigger, the search finds all events in an acquisition that fulfill the search condition. The results are listed in a table and can be saved to file.

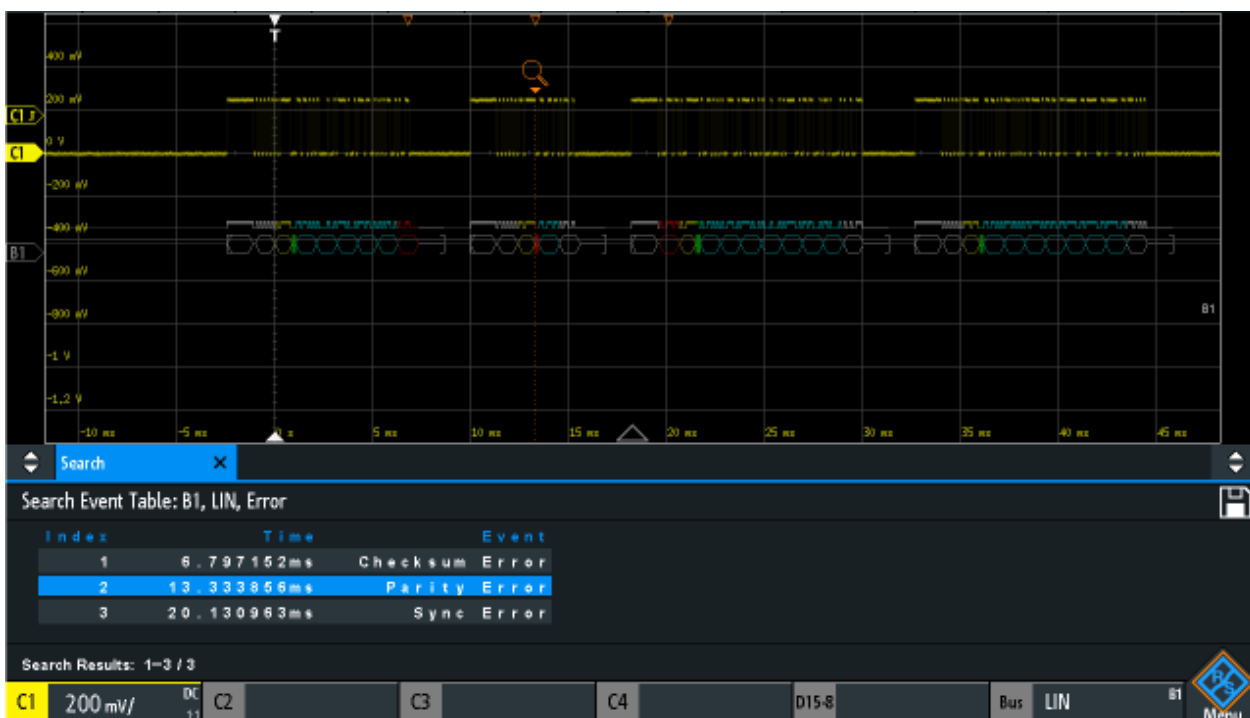

Figure 12-34: Search on a LIN bus for errors

To search for events in a LIN signal

1. Configure and decode the bus correctly.
2. Acquire decoded data.
3. Press the Search key.
4. Select the "Search Type" = "Protocol".
5. Select the "Source": the bus that is configured for LIN protocol.
6. Select the "Event" you want to search for.
7. Enter additional settings, depending on the event.

LIN Search Settings

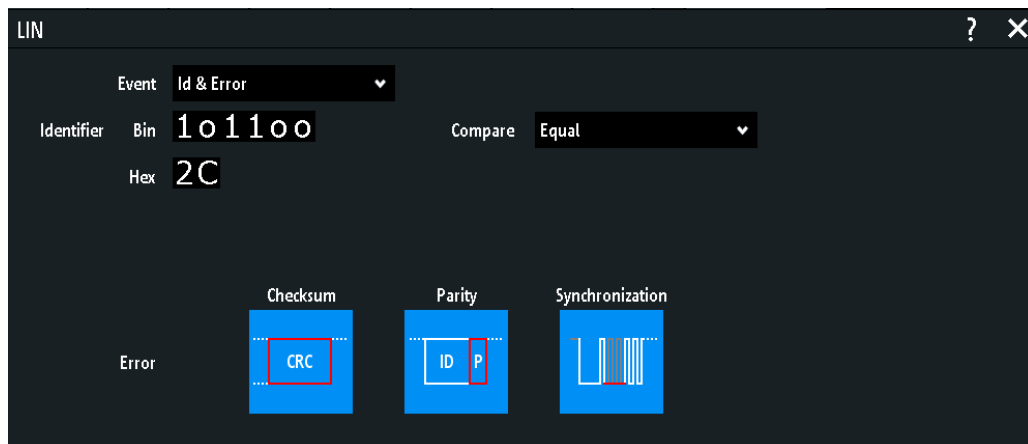

Figure 12-35: Search on LIN bus for frames with identifier 2C (hex) that have an error

Event..... 246
 Frame Setup..... 246
 Error..... 246
 Identifier condition..... 246
 Data condition..... 247

Event

Sets the event or combination of events to be searched for. Depending on the selected event, additional settings are displayed.

Remote command:

[SEARCh:PROTOcol:LIN:CONDition](#) on page 494

Frame Setup

Selects the frame type to be searched for.

Remote command:

[SEARCh:PROTOcol:CAN:FRAME](#) on page 481

Error

Selects the error type to be searched for. You can select one or more error types as search condition. The error types are the same as in the LIN trigger setup.

See also "Error" on page 242.

The setting is only available if "Event" = "Error" or "ID & Error" is selected.

Remote command:

[SEARCh:PROTOcol:LIN:CHKSError](#) on page 495

[SEARCh:PROTOcol:LIN:IPERror](#) on page 495

[SEARCh:PROTOcol:LIN:SYERror](#) on page 495

Identifier condition

Settings to define the identifier pattern, if "Event" = "Identifier" or "Id & Error" or "Id & Data" is selected.

After setting the "Compare" condition, you can enter the identifier value by setting the state high, low, or X (do not care) for each single bit. Alternatively, you can enter a hexadecimal value for each half byte.

The settings are the same as for the setup of the identifier trigger, see also "[Identifier condition](#)" on page 242.

If a label list with node names was loaded and applied in the bus configuration, you can select the node name from the list instead of entering the numeric identifier. The instrument triggers on the identifier of the selected node.

Remote command:

[SEARCH:PROTOCOL:LIN:ICONdition](#) on page 495

[SEARCH:PROTOCOL:LIN:IDENTifier](#) on page 496

Data condition

Settings to define the data pattern to be searched, if "Event" = "Id & Error" is selected.

After setting the "Data" length and the "Compare" condition, you can enter the data value by setting the state high, low, or X (do not care) for each single bit. Alternatively, you can enter a hexadecimal value for each half byte.

The settings are the same as for the setup of the data trigger, see also "[Data condition](#)" on page 243.

Remote command:

[SEARCH:PROTOCOL:LIN:DLENGTH](#) on page 496

[SEARCH:PROTOCOL:LIN:DCONDITION](#) on page 496

[SEARCH:PROTOCOL:LIN:DATA](#) on page 496

12.6.6 LIN Label List

For general information on label lists, see [Chapter 12.1.5, "Label List"](#), on page 195.

Label lists are protocol-specific. Label lists for LIN are available in CSV and PTT format.

A LIN label file contains two values for each identifier:

- Identifier value
- Symbolic name for the identifier

Example of a LIN PTT file

```
# -----
@FILE_VERSION = 1.0
@PROTOCOL_NAME = lin
# -----
# Labels for LIN protocol
#   Column order: Identifier, Label
# -----
# Labels for standard addresses
0x3F, Temperature
1Ch, Left brake
20h, Right brake
```

```
# Following ID is provided as integer
33,Mirror
0x37,Indoor lights
# Labels for reserved addresses
0x3C,Master_Request_Frame
0x3D,Slave_Response_Frame
# -----
```

Label List: LIN (Imported on: 2017-03-30; 16:50)

Symbolic Label	ID / Addr
Dashboard	0x03
Door controller	0x2E
Gateway	0x02
Indoor lights	0x37
Master_Request_Frame	0x3C
Mirror	0x01
Reserved_Frame	0x3F
Slave_Response_Frame	0x3D
Temperature	0x04
User_Defined_Frame	0x3E

Figure 12-36: Label list for LIN



Figure 12-37: Decoded LIN signal with frame table and applied label list

- gray = synchronization break, synchronization byte, correct checksum
- yellow = identifier
- green = parity bits
- blue = data words (UART words)

13 Logic Analyzer (Option R&S RTB-B1, MSO)

The Mixed Signal Option R&S RTB -B1 adds logic analyzer functions to the classical oscilloscope functions. Using the logic analyzer, you can analyze and debug embedded systems with mixed-signal designs that use analog signals and time-correlated digital signals simultaneously. The option provides 16 logic channels grouped in two logic probes (pods) with 8 channels each. The instrument ensures that analog and digital waveforms are time-aligned and synchronized so that critical timing interactions between analog and digital signals can be displayed and tested.

NOTICE

Ensuring accurate measurement results

The logic analyzer option R&S RTB-B1 with connected probe leads is considered as a test probe, according to EN 61326-2-1, clause 5.2.4.101. Therefore, the measurements are sensitive to electromagnetic interference. Consider additional shielding methods to avoid interference.

Consider the following guidelines for good probing practices:

- Attach the ground lead from each pod to the ground of the device under test if any logic channel of the pod is used for data capture. The ground lead improves signal fidelity to the oscilloscope, ensuring accurate measurements.
- For high-speed timing measurements (rise time < 3 ns), use an own ground for each pod.

To activate logic analysis

- ▶ Press the [Logic] key.

13.1 Short Menu for Logic Channels

There are two short menus that show the status of the logic channels, one for the pod "D7...D0" and one for the pod "D15...D8".

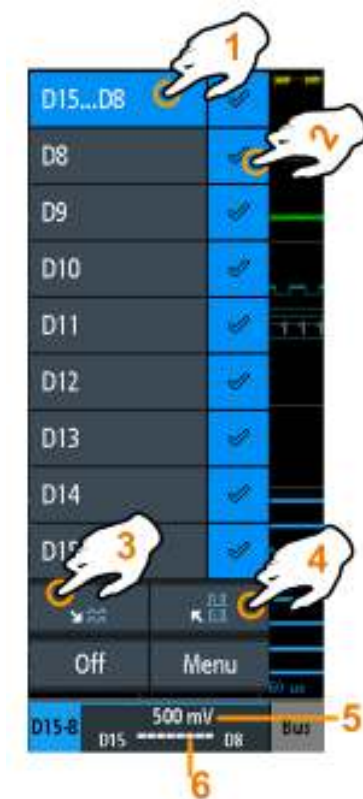

- ▶ To open the short menu for logic channels, tap the pod label in the bottom line of the display.
If the pod was not selected, tap twice: once to select the pod, and next to open the short menu.



- 1 = selects all/one logic channel
- 2 = displays the logic channel
- 3 = scales all visible channels to a minimum
- 4 = scales all visible channels to a maximum
- 5 = shows the threshold of the channels
- 6 = shows the activity of the logic channel

Logic channels - activity display

The activity symbols of the logic channel show the current status of all logic channels and can have the following values:

- : logic channel is low
- : logic channel is high
- : a change in the state of the logic channel has occurred during the measuring interval

Remote commands:

- [LOGic<p>:PROBe\[:ENABle\]? on page 497](#)
- [DIGital<m>:CURRent:STATe:MINimum? on page 497](#)
- [DIGital<m>:CURRent:STATe:MAXimum? on page 497](#)
- [LOGic<p>:CURRent:STATe:MINimum? on page 497](#)
- [LOGic<p>:CURRent:STATe:MAXimum? on page 497](#)

13.2 Logic Analyzer Settings

Prerequisite: a logic probe is connected to the instrument.

1. If logic analysis is not active, press the [Logic] key to activate it.
2. Press the [Logic] key again.
The "Logic" menu opens.
3. Select the "Logic Probe" that you want to use.
4. Enable the "State".
5. Set the "Threshold", and the "Hysteresis".



Logic Probe

Selects the logic probe (pod) to be configured: "D7...D0" or "D15...D8".

State

Switches the selected logic pod on or off.

You can also set the state of each logic channel separately in the short menu, see [Chapter 13, "Logic Analyzer \(Option R&S RTB-B1, MSO\)"](#), on page 250.

Remote command:

`LOGic<p>:STATe` on page 498

Threshold

Selects the threshold level: 3 predefined threshold levels and user-defined threshold are available.

- | | |
|--------------|--------------------------------------------------------------------------------------------------------------------|
| "TTL: 1.4V" | Sets the threshold to 1.4 V, which is typically used in transistor–transistor logic (TTL). |
| "CMOS: 2.5V" | Sets the threshold to 2.5 V, which is typically used in complementary metal-oxide–semiconductor technology (CMOS). |

"ECL: -1.3V" Sets the threshold to -1.3 V, which is typically used in emitter-coupled logic (ECL).

"User Level" Selects the user-defined threshold.
Enter the value in [User Level](#).

Remote command:

[DIGital<m>:TECHnology](#) on page 499

[LOGic<p>:THReshold](#) on page 499

[LOGic<p>:THReshold:UDLevel](#) on page 499

User Level

Sets the threshold level value between -2 V and +8 V in steps of 10 mV, or shows the value of the selected technology.

Remote command:

[DIGital<m>:THReshold](#) on page 499

[LOGic<p>:THReshold:UDLevel](#) on page 499

Hysteresis

Defines the size of the hysteresis to avoid the change of signal states due to noise.

Remote command:

[LOGic<p>:HYSTeresis](#) on page 500

[DIGital<m>:HYSTeresis](#) on page 500

Label

Opens a menu to specify user-defined text labels for the individual logic channels.

Bit ← Label

Selects the logic channel or "Bit" for labeling.

- For the pod "D7...D0", you can select bit "D0", "D1", "D2", ... or "D7".
- For the pod "D15...D8", you can select bit "D8", "D9", "D10", ... or "D15".

Label ← Label

Enables or disables the user-defined label for the selected logic channel.

Remote command:

[DIGital<m>:LABel:STATe](#) on page 501

Predefined Label ← Label

Selects a predefined label text. You can edit the text with "Edit Label".

Edit Label ← Label

Opens on-screen keypad to enter a label text. If you previously have selected a predefined label, it is already written in the entry line, and you can modify it.

The maximum name length is 8 characters, and only ASCII characters provided on the on-screen keypad can be used.

Remote command:

[DIGital<m>:LABel](#) on page 501

13.3 Triggering on Logic Channels

Each logic channel can be used as trigger source. Using the pattern trigger, you can trigger on logical combinations of analog and digital channels. Also, you can define a trigger holdoff time.

If you trigger on logic channels, the threshold is used as trigger level.

The following trigger types are available if the trigger source is a logic channel:

- Edge
- Width
- Pattern: the pattern can use all active logic channels
- Timeout

For analysis of serial protocols, you configure the protocol using logic channels as sources, and trigger on trigger type "Serial Bus". For details, see the chapter describing the relevant bus.

13.4 Analyzing Logic Channels

The main analysis tools for logic channels are serial protocol analysis ([Protocol]) and the pattern triggers.

Furthermore, you can display all logic channels and change the vertical scale position. You can also zoom into the display ([Zoom]).

To measure logic channels, you can use automatic and cursor measurements as usual.

See also [Chapter 7.2, "Automatic Measurements"](#), on page 112 and [Chapter 7.3, "Cursor Measurements"](#), on page 121.

You can also export the waveform data: [Save Load] key > "Waveforms"

13.5 Parallel Buses

The R&S RTB2000 can display and decode up to 16 lines of a parallel bus. You can assign the logic channels to the bus bits individually.

To trigger on parallel buses, use the pattern trigger, see [Chapter 5.7, "Pattern Trigger"](#), on page 69.

- [Parallel Bus Configuration](#).....255
- [Decode Results](#).....257

13.5.1 Parallel Bus Configuration

You can configure a parallel bus or a parallel clocked bus. For the parallel clocked bus, a clock line and an optional chip select line are defined in addition to the other settings.

Access: [Protocol] > "Bus Type" = "Parallel" / "Parallel Clocked" > "Configuration"

The following configuration menu opens:

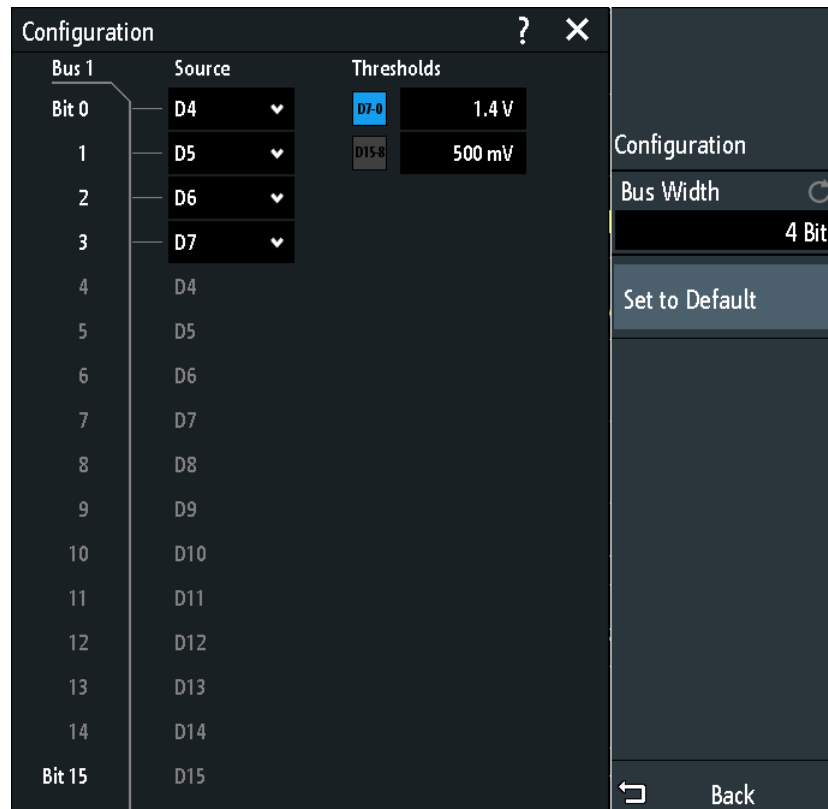

Figure 13-1: Configuration menu Parallel bus

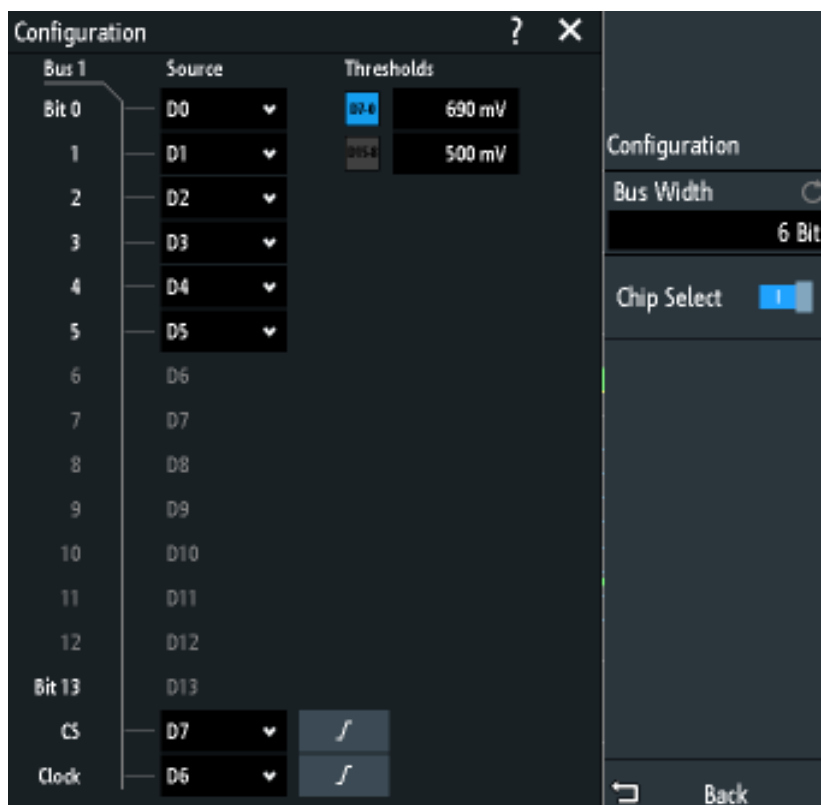

Figure 13-2: Configuration menu Parallel clocked bus

The menus offer the following settings:

Bus Width	256
Thresholds	256
Source	257
Set to Default	257
Chip Select	257
Polarity	257
Slope	257

Bus Width

Sets the number of lines (bits) of the logic channels D0 to D15 to be analyzed in the parallel or clocked parallel bus. The maximum number is the number of logic input lines.

Remote command:

[BUS:PARAllel:WIDTh](#) on page 504

[BUS:CPARAllel:WIDTh](#) on page 504

Thresholds

Separately sets the thresholds for the source lines D0 to D7 and for the source lines D8 to D15 of the parallel or clocked parallel bus.

The setting is also available in the "Logic" configuration.

Remote command:

[DIGital<m>:THReshold](#) on page 499

Source

Selects the input line for each bit of the parallel or clocked parallel bus.

If you use a clocked parallel bus, in the last two lines you can select the source for the "Clock" and "CS".

Remote command:

[BUS:PARAllel:DATA<m>:SOURce](#) on page 504

[BUS:CPARAllel:DATA<m>:SOURce](#) on page 504

[BUS:CPARAllel:CLOCK:SOURce](#) on page 505

[BUS:CPARAllel:CS:SOURce](#) on page 505

Set to Default

Resets the data lines of the parallel bus to the default order D0...D15.



Chip Select

Enables the chip select line for the parallel clocked bus.

Remote command:

[BUS:CPARAllel:CS:ENABle](#) on page 505



Polarity

For the parallel clocked bus, selects if the chip select signal is high active ( high = 1) or low active ( low = 1).

Remote command:

[BUS:CPARAllel:CS:POLarity](#) on page 506

Slope

For the parallel clocked bus, selects if the data is sampled on the rising () or falling () slope of the clock, or on both edges () of a double data rate clock. The clock slope marks the begin of a new bit.

Remote command:

[BUS:CPARAllel:CLOCK:SLOPe](#) on page 505

13.5.2 Decode Results

When the configuration of the parallel bus is complete, the signal can be decoded:

1. In the "Bus" menu, enable "Decode".
2. In the "Display" menu, select the result display settings.
See [Chapter 12.1.2, "Displaying Decode Results"](#), on page 191.
3. In the "Bus Table" menu, enable the "Bus Table". Adjust the table settings.
See also: [Chapter 12.1.3, "Bus Table: Decode Results"](#), on page 192

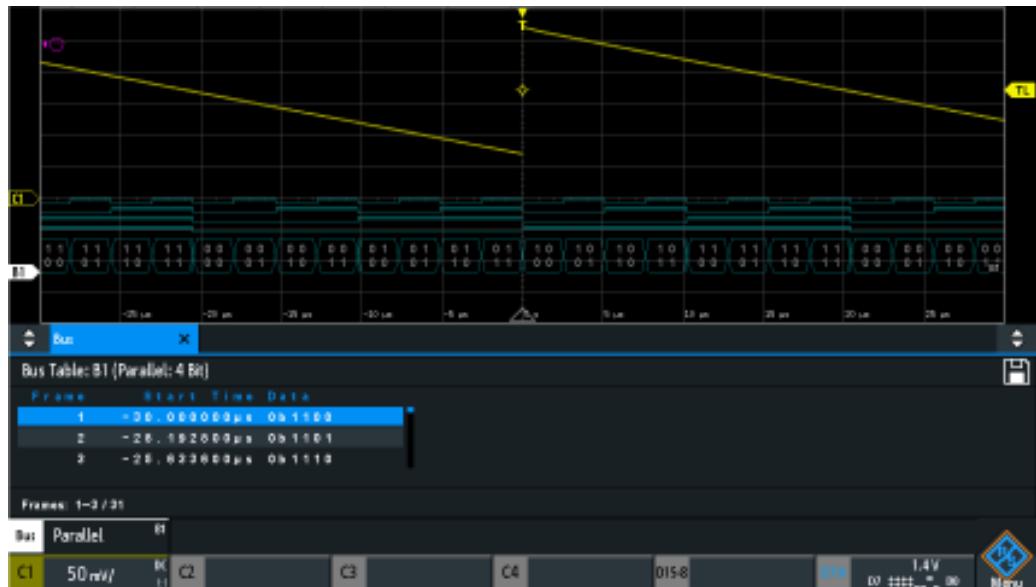

Figure 13-3: Decoded Parallel bus signal with bus table

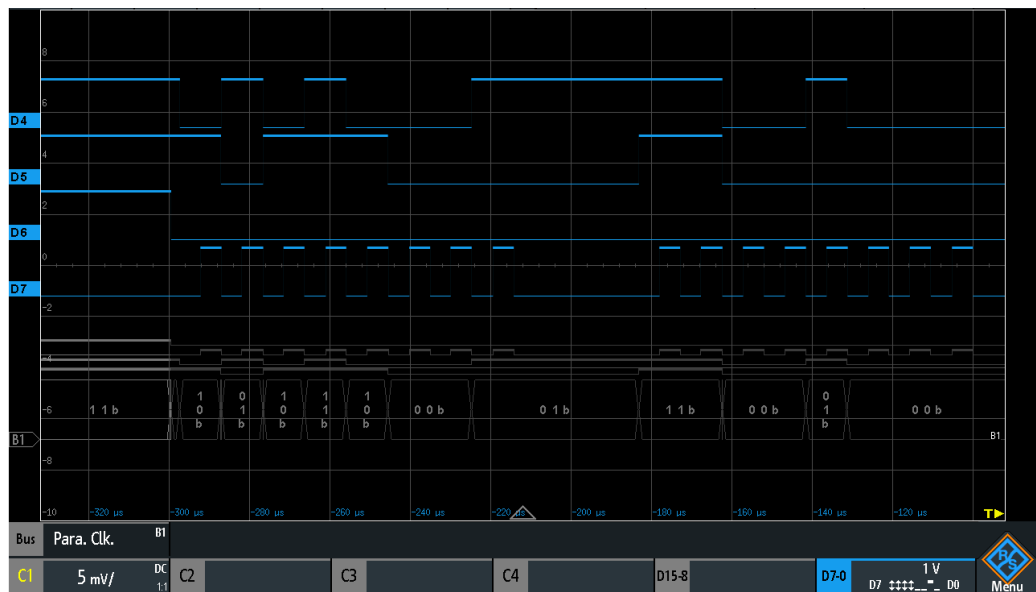

Figure 13-4: Decoded Parallel clocked bus signal

The bus table shows the data of decoded frames and the corresponding start time. Remote commands are described in [Chapter 15.12.2.3, "Parallel Buses - Decode Results"](#), on page 506.

14 Signal Generation (Option R&S RTB-B6)

The R&S RTB2000 has an integrated function and pattern generator which can generate signals while testing circuits, for instance.

The waveform generator can output simple functions, modulated sine waveform, arbitrary waveforms and sweep waveforms. The integrated pattern generator can generate individual or cycle patterns and simple bus signal patterns.

14.1 Function Generator

The waveform generator can output simple functions, modulated sine waveform, arbitrary waveforms and sweep waveforms. The signal is output at the [Aux Out] connector on the front panel.

Short Menu

In the short menu for the function generator, you can open the comprehensive menu, and turn off the function generator.

You can also create an arbitrary waveform by copying a waveform and display or hide the arbitrary waveform. For description of the functions in the short menu, see [Chapter 14.1.6, "Arbitrary Setup Settings"](#), on page 269.

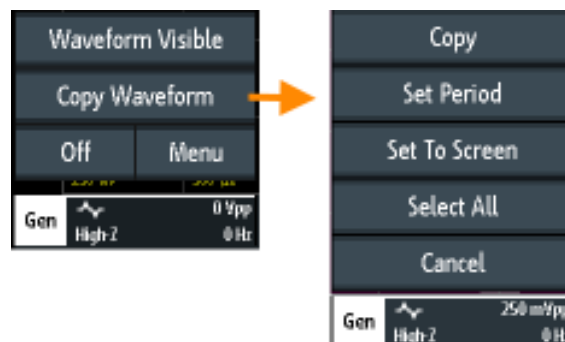

Figure 14-1: Short menu to create arbitrary waveform

14.1.1 Using the Function Generator

To configure a function waveform

1. Press the [Gen] key on the front panel.
2. Select the "Function" that you want to generate, e.g. "Sine".
3. Depending on the selected "Function", configure the settings of the waveform like "Frequency" and "Amplitude".

4. Activate "Output", to output the waveform at the [Aux Out] connector at the front panel.

To generate a modulated waveform

Modulation settings are described in [Chapter 14.1.4, "Modulation Settings"](#), on page 266.

1. Press the [Gen] key on the front panel.
2. Configure the carrier waveform as described above.
3. Tap "Modulation".
4. In the "Modulation" menu, tap "Modulation Type" and select the modulation type, e.g. "AM".
5. Depending on the selected "Modulation Type", configure the settings of the waveform.
6. Enable "Modulation" to activate the modulation.
7. Tap "Back".
8. Activate "Output", to output the waveform at the [Aux Out] connector at the front panel.

To generate an arbitrary waveform using the comprehensive menu

Settings are described in [Chapter 14.1.6, "Arbitrary Setup Settings"](#), on page 269.

1. Capture and display the waveform that is the basis for the arbitrary waveform.
2. Press the [Gen] key on the front panel.
3. Select "Function" > "Arbitrary".
4. Set the frequency, amplitude, and offset of the waveform to be generated.
5. Tap "Arbitrary Setup".
6. Select the "Source" waveform.
7. To select a sector of the existing waveform, tap "Cut Waveform". Do one of the following:
 - a) Set the "Start" and "Stop" time to select an area.
 - b) Drag the limit lines of the area to change the start and stop time.
 - c) Tap "Set Period" to set the copy to the first period of the waveform.
 - d) Tap "Set To Screen", to set the copy area within the screen around the trigger point.
 - e) Tap "Select All" to use the complete waveform.
8. Press "Copy" to create the arbitrary waveform from the selected "Source" and the "Cut Waveform" limits.

The arbitrary waveform is automatically saved.

9. Tap "Visible" to enable the arbitrary waveform.
The arbitrary waveform is shown in magenta color. If the arbitrary waveform was created from a part of the displayed channel waveform, this part is stretched in horizontal direction to fill all divisions.
10. To load an existing arbitrary waveform or a saved reference waveform, tap "Load". Select the waveform file.
11. Tap "Back".
12. Activate "Output", to output the waveform at the [Aux Out] connector at the front panel.
The created arbitrary waveform is output at the [Aux Out] connector at the front panel, with the frequency, amplitude and offset that are set in the "Function Generator" menu.

To generate an arbitrary waveform using the short menu

Settings are described in [Chapter 14.1.6, "Arbitrary Setup Settings"](#), on page 269.

1. Capture and display the waveform that is the basis for the arbitrary waveform.
2. Press the [Gen] key on the front panel.
3. Select "Function" > "Arbitrary".
4. Set the frequency, amplitude, and offset of the waveform to be generated.
5. Activate "Output".
6. Open the short menu of the function generator in the bottom menu.
7. Tap "Copy Waveform".
8. To select a sector of the existing waveform, tap "Cut Waveform". Do one of the following:
 - a) Drag the limit lines of the area to change the start and stop time.
A time edit field is shown, where you also can set the "Start" and "Stop" time.
 - b) Tap "Set Period" to set the copy to the first period of the waveform.
 - c) Tap "Set To Screen", to set the copy area within the screen around the trigger point.
 - d) Tap "Select All" to use the complete waveform.
9. Press "Copy" to create the arbitrary waveform the "Cut Waveform" limits.
The arbitrary waveform is shown in magenta color. If the arbitrary waveform was created from a part of the displayed channel waveform, this part is stretched in horizontal direction to fill all divisions. The arbitrary waveform is automatically saved. The created arbitrary waveform is output at the [Aux Out] connector at the front panel, with the frequency, amplitude and offset that are set in the "Function Generator" menu.

To configure a burst

Burst settings are described in [Chapter 14.1.5, "Burst Settings"](#), on page 268.

1. Press the [Gen] key on the front panel.
2. Configure the signal waveform as described above.
3. Select the "Burst" tab.
4. Set the "N-Cycle", the "Idle Time" and the "Start Phase".
5. Set the "Trigger" to "Cont." or "Manual".
6. Tap "Back".
7. Activate "Output", to output the waveform at the [Aux Out] connector at the front panel.

To configure a sweep waveform

Weep settings are described in [Chapter 14.1.3, "Sweep Settings"](#), on page 265.

1. Press the [Gen] key on the front panel.
2. Configure the signal waveform as described above.
3. Select the "Sweep" tab.
4. Set the "Start Frequency", the "Stop Frequency" and the "Sweep Time".
5. Press "Sweep" to enable the sweep.
6. Tap "Back".
7. Activate "Output", to output the waveform at the [Aux Out] connector at the front panel.

14.1.2 Basic Settings of the Function Generator

Access: [Gen] key

For a step-by-step description, see ["To configure a function waveform"](#) on page 259.

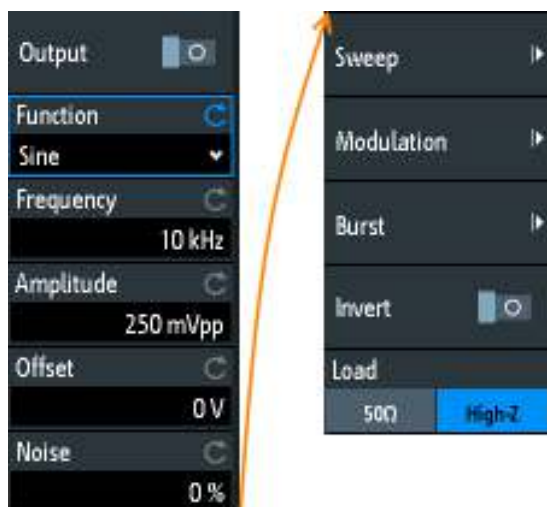

Output

Enables the function generator.

Remote command:

[WGEnerator:OUTPut\[:ENABle\]](#) on page 510

Function

Selects the type of waveform to be generated. For all waveforms, you can set the [Frequency](#), [Amplitude](#), [Offset](#), and [Noise](#).

"DC"	Generates a direct current (DC) signal.
"Sine"	Generates a sine wave.
"SinC"	Generates a cardinal sine wave.
"Rectangle"	Generates a square wave.
"Pulse"	Generates a pulse signal. Additional settings are the Duty Cycle and the Edge Time .
"Triangle"	Generates a triangle signal.
"Ramp"	Generates a ramp signal. You can set the Polarity .
"Arbitrary"	Generates an arbitrary waveform, which is copied from an existing waveform, or loaded from file. See Chapter 14.1.6, "Arbitrary Setup Settings" , on page 269.
"Exponential"	Generates an exponential rise signal. You can set the Polarity .

Remote command:

[WGEnerator:FUNCTion](#) on page 508

Frequency

Sets the frequency of the waveform. The available frequency range depends on the selected function. The frequency ranges are provided the datasheet.

Remote command:

[WGEnerator:FREQUency](#) on page 509

Polarity

Sets the polarity.

For the "Exponential" function, you can choose between a rising or falling exponential. For the "Ramp" function, you can set a positive or negative polarity.

Remote command:

[WGENerator:FUNCTION:EXPonential:POLarity](#) on page 509

[WGENerator:FUNCTION:RAMP:POLarity](#) on page 509

Edge Time

Sets the pulse edge time.

Remote command:

[WGENerator:FUNCTION:PULSe:ETIME](#) on page 509

Duty Cycle

Sets the duty cycle for the pulse function. The duty cycle expresses for what percentage of the period, the signal state is high.

Remote command:

[WGENerator:FUNCTION:PULSe:DCYCLE](#) on page 509

Amplitude

Sets the amplitude of the waveform.

Remote command:

[WGENerator:VOLTage](#) on page 508

Offset

Sets the vertical offset of the generated waveform.

Remote command:

[WGENerator:VOLTage:OFFSet](#) on page 509

Noise

Sets the noise of the generated waveform.

Remote command:

[WGENerator:NOISe:ABSolute](#) on page 510

[WGENerator:NOISe:RELative](#) on page 510

Arbitrary Setup

Opens a menu to configure the arbitrary waveform.

See [Chapter 14.1.6, "Arbitrary Setup Settings"](#), on page 269.

Sweep

Opens a menu to configure the sweep.

See [Chapter 14.1.3, "Sweep Settings"](#), on page 265.

Modulation

Opens a menu to configure the modulation.

See [Chapter 14.1.4, "Modulation Settings"](#), on page 266.

Invert

Inverts the waveform at the offset level.

Load

Select the user load, the load of the DUT at its connection. You can select either a "50Ω" or a "High-Z" (high input impedance) load.

Remote command:

[WGENerator:OUTPut:LOAD](#) on page 510

14.1.3 Sweep Settings

Access: [Gen] key > "Sweep"

In the sweep mode, the R&S RTB2000 generates a signal whose frequency gradually changes from the [Start Frequency](#) to the [Stop Frequency](#) for a certain [Sweep Time](#).

For a step-by-step description of the sweep setup, see "[To configure a sweep waveform](#)" on page 262.

**Sweep**

Enables or disables the sweeping.

Remote command:

[WGENerator:SWEEp\[:ENABLE\]](#) on page 516

Start Frequency

Sets the start frequency of the sweep signal.

Remote command:

[WGENerator:SWEEp:FStart](#) on page 515

Stop Frequency

Sets the stop frequency of the sweep signal.

Remote command:

[WGENerator:SWEEp:FEND](#) on page 515

Sweep Time

Sets the duration of the sweep.

Remote command:

[WGENerator:SWEep:TIME](#) on page 515

Sweep

Sets the type of the sweep, a linear, logarithmic or triangle-shaped change of the frequency. The triangle-shaped sweep will run from the "Start Frequency" to the "Stop Frequency" and then from the "Stop Frequency" back to the "Start Frequency".

Remote command:

[WGENerator:SWEep:TYPE](#) on page 515

14.1.4 Modulation Settings

Access: [Gen] key > "Modulation"

Modulation is the variation of properties of an original periodic waveform according to a second modulating signal. The type of modulation determines which properties are changed.

For a step-by-step description of the modulation setup, see "[To generate a modulated waveform](#)" on page 260.

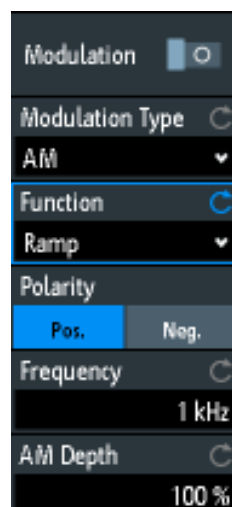
**Modulation**

Enables or disables modulation.

Remote command:

[WGENerator:MODulation\[:ENABLE\]](#) on page 513

Modulation Type

Selects the modulation type, which defines how the carrier signal is modified.

"AM" Amplitude modulation. The amplitude of the carrier signal is varied according to the modulation signal.

"FM"	Frequency modulation. The frequency of the carrier signal is varied according to the modulation signal.
"ASK"	Amplitude shift keying (ASK) modulation. The amplitude switches between 100% and the "ASK Depth" amplitude with a defined modulating "Frequency".
"FSK"	Frequency shift keying (FSK) modulation. The signal frequency switches between the carrier "Frequency" and the "Hop. Frequency" at a "FSK Rate".

Remote command:

[WGENerator:MODulation:TYPE](#) on page 513

Function

Selects the type of the modulating signal for AM or FM modulation.

Remote command:

[WGENerator:MODulation:FUNCTION](#) on page 513

Frequency

Sets the frequency of the modulating waveform for AM/FM/ASK modulation.

Remote command:

[WGENerator:MODulation:AM:FREQUENCY](#) on page 513

[WGENerator:MODulation:FM:FREQUENCY](#) on page 514

[WGENerator:MODulation:ASK:FREQUENCY](#) on page 514

AM Depth

Sets the modulation depth, the percentage of the amplitude range that is used for AM modulation.

Remote command:

[WGENerator:MODulation:AM:DEPTH](#) on page 514

Deviation

Sets the frequency deviation, the maximum difference between the FM modulated signal and the carrier signal.

Remote command:

[WGENerator:MODulation:FM:DEVIATION](#) on page 514

ASK Depth

Sets the modulation depth, the percentage of the amplitude range that is used for ASK modulation.

Remote command:

[WGENerator:MODulation:ASK:DEPTH](#) on page 514

Polarity

Sets the polarity of the ramp function for AM and FM modulation.

Remote command:

[WGENerator:MODulation:RAMP:POLARITY](#) on page 515

Hop. Frequency

Sets the second frequency of the FSK-modulated signal.

Remote command:

[WGENerator:MODulation:FSK:HFREquency](#) on page 514

FSK Rate

Sets the rate at which signal switches between the carrier frequency and the hopping frequency.

Remote command:

[WGENerator:MODulation:FSK:RATE](#) on page 515

14.1.5 Burst Settings

Access: [Gen] key > "Burst"

With the burst mode, you can output a waveform for a set number of times.

For a step-by-step description of the modulation setup, see ["To configure a burst"](#) on page 262.

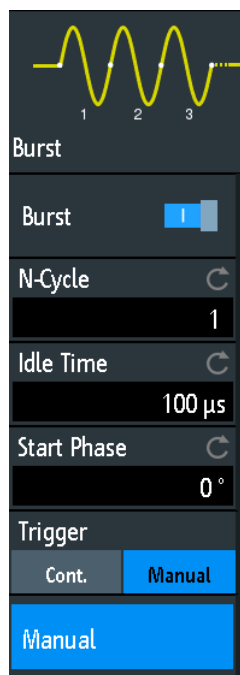
**Burst**

Enables or disables the burst.

Remote command:

[WGENerator:BURSt\[:STATe\]](#) on page 512

N-Cycle

Sets the number of times the generator outputs one cycle of the waveform per burst.

Remote command:

[WGENerator:BURSt:NCYCle](#) on page 512

Idle Time

Sets the idle time between two burst cycles.

Remote command:

[WGENerator:BURSt:ITIME](#) on page 512

Start Phase

Sets the start phase of the burst.

Remote command:

[WGENerator:BURSt:PHASe](#) on page 512

Trigger

Selects the trigger mode. Each time the generator receives a trigger, it outputs a burst with the number of cycles defined with "N-Cycle".

In the continuous mode, the oscilloscope outputs continuously when the burst is enabled.

In the manual mode, you have to press "Manual" to output a burst.

14.1.6 Arbitrary Setup Settings

Access: [Gen] key > "Arbitrary Setup"

An arbitrary waveform is copied from an existing waveform on the instrument, or loaded from file. You can display the arbitrary waveform on the screen.

For a step-by-step description of the modulation setup, see "[To generate an arbitrary waveform using the comprehensive menu](#)" on page 260.



Visible

Enables the display of the arbitrary waveform.

Remote command:

[WGNErator:ARBitrary:VISible](#) on page 511

Source

Selects the source of the arbitrary waveform. You can load an existing file or load the current oscilloscope waveform.

Remote command:

[WGNErator:ARBitrary:SOURce](#) on page 510

Copy

Loads the waveform from the selected "Signal source" or the waveform part selected with "Cut Waveform".

Remote command:

[WGNErator:ARBitrary:UPDate](#) on page 511

Cut Waveform

Provides the settings to refine the part of the waveform to be copied.

**Set Period ← Cut Waveform**

Sets the copy area to the first period of the waveform.

Set To Screen ← Cut Waveform

Sets the copy area within the screen.

Select All ← Cut Waveform

Selects the whole waveform.

Start ← Cut Waveform

Sets the start time of the copy area.

Remote command:

[WGENerator:ARBitrary:RANGe:START](#) on page 511

Stop ← Cut Waveform

Sets the stop time of the copy area.

Remote command:

[WGENerator:ARBitrary:RANGe:STOP](#) on page 511

Load

Opens a file selection dialog box and loads the selected file. The instrument supports .trf and .csv file formats, the same formats like for reference waveforms.

Remote command:

[WGENerator:ARBitrary\[:FILE\]:NAME](#) on page 511

[WGENerator:ARBitrary\[:FILE\]:OPEN](#) on page 511

14.2 Pattern Generator

The pattern generator outputs parallel patterns on the four pins P0 to P3 on the front panel of the instrument.

1. Press the  [Apps Selection] key.
2. Tap "Pattern Gen."

A dialog box shows the pins, on which the pattern is output, depending on the selected pattern.

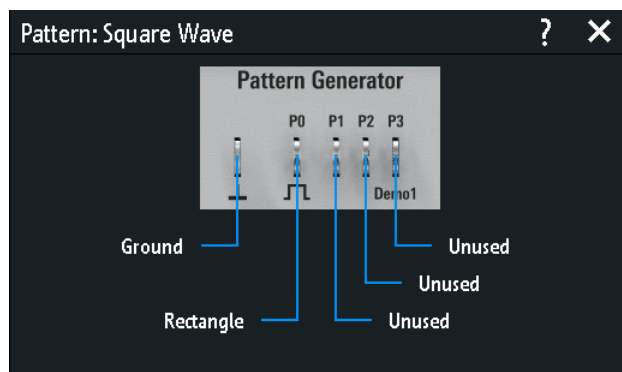

14.2.1 Pattern Selection

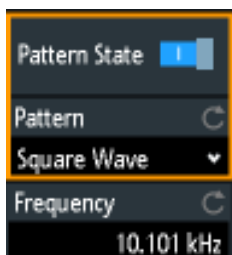

Pattern State

Enables or disables the pattern output at the pins P0 to P3.

Remote command:

[PGenerator: PATtern: STATe](#) on page 517

Pattern

Selects the pattern type.

"Square Wave" Generates a square wave pattern at pin P0.

"Counter" Generates a 4-bit wide counter pattern at pins P0 to P3.

"Arbitrary" Creates, saves or loads an arbitrary 4-bit wide pattern and outputs it at pins P0 to P3.

"Manual" Sets the high or low state for each pin.

"UART, SPI, I2C, CAN, LIN, Audio -I2S, Audio- TDM" Generates a bus signal for measurements without measurement object.

Remote command:

[PGenerator: FUNction](#) on page 516

14.2.2 Settings for Square Wave Pattern

Access: "Menu" > "Pattern Gen." > "Pattern" = "Square Wave"

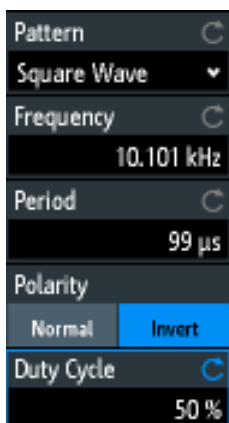

Frequency

Sets the frequency of the square wave.

The values of the "Frequency" and "Period" depend on each other, as:

$$\text{Period} = 1 / \text{Frequency}$$

If you change the value, the "Period" is adjusted accordingly.

Remote command:

[PGenerator: PATtern: FREquency](#) on page 518

Period

Sets the period of the square wave. If you change the value, the "Frequency" is adjusted accordingly.

Remote command:

[PGenerator: PATtern: PERiod](#) on page 517

Polarity

Sets normal or inverted polarity.

Remote command:

[PGenerator: PATtern: SQUarewave: POLarity](#) on page 521

Duty Cycle

Sets the duty cycle of the square wave from 1% to 99%. The duty cycle expresses for what percentage of the period, the signal state is high.

Remote command:

[PGenerator: PATtern: SQUarewave: DCYCLE](#) on page 521

14.2.3 Settings for Counter Pattern

Access:  "Menu" > "Pattern Gen." > "Pattern" = "Counter"

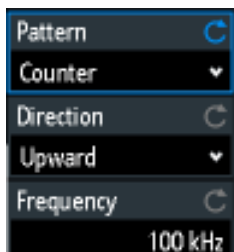
**Frequency**

Sets the switching frequency, how fast the pattern condition changes. The square waveforms at the pins have the following resulting frequencies:

- P0: $f/2$
- P1: $f/4$
- P2: $f/8$
- P3: $f/16$

Remote command:

[PGenerator: PATtern: COUNTER: FREquency](#) on page 520

Direction

Changes the counting direction.

Remote command:

[PGenerator: PATtern: COUNter: DIRection](#) on page 521

14.2.4 Settings for Arbitrary Pattern

Access:  "Menu" > "Pattern Gen." > "Pattern" = "Arbitrary"

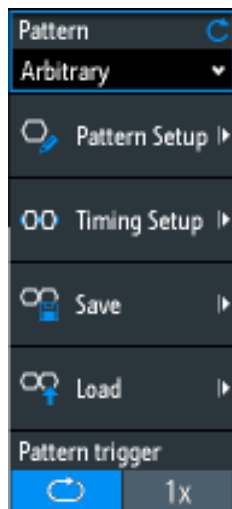
**14.2.4.1 General Settings****Save**

Opens a dialog box to save a waveform as an ARB pattern. The text files containing remote commands are saved in *.scp format.

You can select the "Location" to which the waveform file (internal or USB) is saved.

Tap "Save" to save the file under the current name.

Tap "New File" and enter the name of the new file you want to save.

You can also delete obsolete files in the dialog box.

Load

Provides functions to load an ARB waveform.

Select the "Location" of the waveform file (internal or USB), and the file. Tap "Load".

You can also delete obsolete files in the dialog box.

Pattern trigger

Selects the mode for the trigger for the ARB pattern. You can select an automatic continuous trigger or a manual one time trigger.

Remote command:

[PGenerator: PATtern: TRIGger: MODE](#) on page 519

14.2.4.2 Pattern Setup

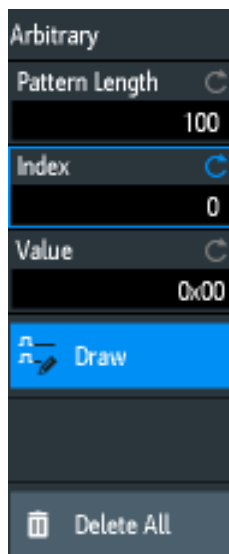

Pattern Length

Sets the pattern length, the number of samples for the pattern.

Remote command:

[PGenerator:PAATtern:ARBitrary:DATA:LENGth](#) on page 520

Index

Selects a sample. The selected sample is shown in the information box as a light blue line. Around the index, ± 8 bits are displayed.

Remote command:

[PGenerator:PAATtern:ARBitrary:DATA:APPend:INDex](#) on page 520

Value

Sets the value of the currently selected "Index".

Draw

If enabled, you can draw large sample amounts with the same value.

Delete All

Deletes the pattern. Also, resets the "Pattern Length" to 1 and the "Value" to 0.

14.2.4.3 Timing Setup

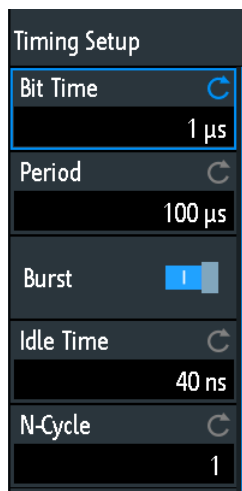

Bit Time

Sets the time at which each sample is applied. The time is identical for all samples.

Remote command:

[PGENerator: PATTern: STIME](#) on page 517

Period

Sets the period of the sample. It applies to the whole pattern. $\text{Period} = \text{Pattern Length} * \text{Bit Time}$

Remote command:

[PGENerator: PATTern: PERiod](#) on page 517

Burst

If activated, the instrument pauses after each issued pattern for the duration of the "Idle Time".

Remote command:

[PGENerator: PATTern: BURSt: STATe](#) on page 518

Idle Time

Sets the idle time, the time for which the instrument pauses after each issued pattern. The "Idle Time" between the patterns can be set from 20 ns to 42 s in increments of 10 ns.

Remote command:

[PGENerator: PATTern: ITIME](#) on page 518

N-Cycle

Sets the number of times the pattern is generated.

Remote command:

[PGENerator: PATTern: BURSt: NCYCLE](#) on page 518

14.2.5 Settings for Manual Pattern

Access:  "Menu" > "Pattern Gen." > "Pattern" = "Manual"

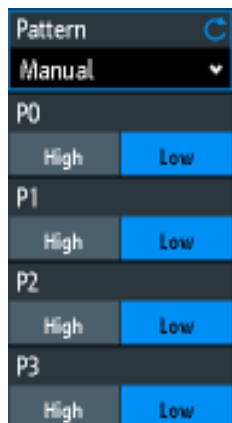

P0/P1/P2/P3

Sets the states to high or low for the respective pin of the manual pattern.

Remote command:

[PGenerator:MANual:STATe<s>](#) on page 521

14.2.6 Settings for Serial Buses

You can use the pattern generator to generate signals according to serial protocols (bus signals).

The generated serial protocol signals are pseudo random pattern and are not adaptable. Only the protocol type and the data rate can be selected.

The contact at the upper left is always ground and the signal levels are about 1 V. The following table shows how the four outputs P0, P1, P2 and P3 are used, depending on the signal.

Signal	P0	P1	P2	P3
UART	Tx	Rx	Unused	Unused
SPI	Clock	Mosi	Miso	Chip Select
I2C	Clock SCL	Data SDA	Unused	Unused
CAN	CAN H	CAN L	Unused	Unused
LIN	High	Low	Unused	Unused

Access:  "Menu" > "Pattern Gen." > "Pattern" = "UART | SPI | I2C | CAN | LIN"

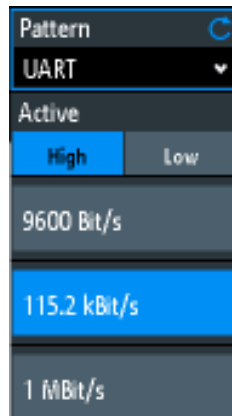

Data Rate

Select the data rate of the bus signal.

The following values are available for the specific bus:

- **UART:** 9600 Bit/s, 115.2 kBit/s, 1 MBit/s
- **SPI:** 100 kBit/s, 250 kBit/s, 1 MBit/s
- **I2C:** 100 kBit/s, 400 kBit/s, 1000 kBit/s, 3400 kBit/s
- **CAN:** 50 kBit/s, 100 kBit/s, 1 MBit/s
- **LIN:** 9.6 kBit/s, 10.417 kBit/s, 19.200 kBit/s

Active

Sets the polarity for the UART bus.

15 Remote Control Commands

This chapter provides the description of all remote commands available for R&S RTB2000. The commands are sorted according to the menu structure of the instrument. A list of commands in alphabetical order is given in the "List of Commands" at the end of this documentation.

Processing of remote control commands

The response time on remote commands depends on several factors:

- Number of active channels
- Number of active measurements
- Size of the acquisition memory
- Timebase
- Trigger frequency

The R&S RTB2000 processes measurement queries in the following way:

- In stop mode or with slow trigger frequency if no new data since last value calculation is available, the oscilloscope sends the measured value in the response.
- Otherwise, if new data since last value calculation is available, the oscilloscope calculates and sends the response.

• Conventions used in Command Description	279
• Programming Examples	280
• Common Commands	286
• Waveform Setup	289
• Trigger	306
• Waveform Analysis	317
• Measurements	349
• Applications	367
• Documenting Results	400
• General Instrument Setup	421
• Serial Bus Analysis	434
• Mixed Signal Option (Option R&S RTB-B1)	497
• Signal Generation (Option R&S RTB-B6)	508
• Status Reporting	522

15.1 Conventions used in Command Description

Note the following conventions used in the remote command descriptions:

- **Command usage**
If not specified otherwise, commands can be used both for setting and for querying parameters.
If a command can be used for setting or querying only, or if it initiates an event, the usage is stated explicitly.
- **Parameter usage**

If not specified otherwise, a parameter can be used to set a value and it is the result of a query.

Parameters required only for setting are indicated as **Setting parameters**.

Parameters required only to refine a query are indicated as **Query parameters**.

Parameters that are only returned as the result of a query are indicated as **Return values**.

- **Conformity**
Commands that are taken from the SCPI standard are indicated as **SCPI confirmed**. All commands used by the R&S RTB2000 follow the SCPI syntax rules.
- **Asynchronous commands**
A command which does not automatically finish executing before the next command starts executing (overlapping command) is indicated as an **Asynchronous command**.
- **Reset values (*RST)**
Default parameter values that are used directly after resetting the instrument (*RST command) are indicated as *RST values, if available.
- **Default unit**
The default unit is used for numeric values if no other unit is provided with the parameter.

15.2 Programming Examples

- [Documenting Results](#).....280
- [Firmware Update](#).....284
- [Search](#).....285
- [Function Generator](#).....286

15.2.1 Documenting Results

- [Saving Screenshots to File](#).....280
- [Saving, Copying, and Loading Setup Data](#).....281
- [Reading Waveform Data in Real Format](#).....282
- [Reading Waveform Data in Unsigned Integer Format](#).....282

15.2.1.1 Saving Screenshots to File

Save two display images in png format to the `PIX` folder on a USB flash drive that is connected to the front panel. One screenshot is colored and the other is grayscaled. Finally, the data of the gray screenshot is read for further user on the control computer.

Command description in: [Chapter 15.9.3, "Screenshots"](#), on page 413.

```
*RST
MMEM:CDIR "/USB_FRONT"
MMEM:MDIR "/USB_FRONT/PIX"
MMEM:CDIR "/USB_FRONT/PIX/"
```



```

HCOP:LANG PNG
HCOP:COL:SCH COL
MMEM:NAME "COLORED"
HCOP:IMM
HCOP:COL:SCH GRAY
MMEM:NAME "GRAY"
HCOP:IMM

MMEM:CAT? "*.PNG"
MMEM:DATA? "GRAY.PNG"

```

15.2.1.2 Saving, Copying, and Loading Setup Data

Save instrument settings to a file on internal storage device, duplicate this file and save it to a USB stick attached to the front panel. Finally, there are three setup files on the internal storage /INT/SETTINGS, and one file on the USB flash device.

Command description in: [Chapter 15.9.4, "Instrument Settings: Mass MEMomory Sub-system"](#), on page 414.

```

CHAN1:STAT ON // Turn channel 1 on
CHAN2:STAT ON // Turn channel 2 on
TIM:ZOOM:STAT ON // Show zoom diagram
MMEM:CDIR "/INT/SETTINGS" // Set storage device and directory
MMEM:STOR:STAT 1,"ZOOM_A.SET" // Save settings to internal storage
MMEM:CAT? "*.SET" // Check
<-- 332112,8633856,"ZOOM_A.SET,,2759"
MMEM:COPY "ZOOM_A.SET","ZOOM_B.SET" // Copy file
MMEM:CAT? "*.SET" // Check
<-- 332112,8633856,"ZOOM_A.SET,,2759","ZOOM_B.SET,,2759"
MMEM:COPY "/INT/SETTINGS/ZOOM_B.SET","/USB_FRONT/ZOOM_B.SET"
// Save copied file to USB stick
MMEM:CDIR "/USB_FRONT" // Check
MMEM:CAT? "*.SET"
<-- 4890624,-641765376,"ZOOM_B.SET,,2759"
MMEM:COPY "/USB_FRONT/ZOOM_B.SET","/USB_FRONT/ZOOM_USB.SET"
// Duplicate file on USB stick
MMEM:CAT? "*.SET" // Check
<-- 4890624,-641765376,"ZOOM_B.SET,,2759","ZOOM_USB.SET,,2759"
MMEM:DEL "ZOOM_B.SET" // Delete original file
MMEM:CAT? "*.SET" // Check
<-- 4886528,-641765376,"ZOOM_USB.SET,,2759"
MMEM:COPY "/USB_FRONT/ZOOM_USB.SET","/INT/SETTINGS/"
// Copy new file to the instrument
MMEM:CDIR "/INT/SETTINGS" // Check
MMEM:CAT? "*.SET"
<-- 332112,8633856,"ZOOM_A.SET,,2759","ZOOM_B.SET,,2759","ZOOM_USB.SET,,2759"
*RST;*OPC?
<-- 1

```

```
MMEM:CDIR "/INT/SETTINGS"
MMEM:LOAD:STAT 1,"ZOOM_USB.SET" // Load settings
```

15.2.1.3 Reading Waveform Data in Real Format

Set data format and sample range, read channel header and data.

Command description in [Chapter 15.9.1, "Transfer of Waveform Data"](#), on page 400.
Return values are example data.

```
// Check instrument connection (example)

* Connected to: TCPIP0::192.168.1.1::inst0::INSTR
SYST:ERR:ALL?
<-- 0,"No error" // if error queue is empty
*IDN?
<-- Rohde&Schwarz,RTB2004,1333.1005K04/101489,02.002

// Read waveform data
*RST
CHAN:TYPE HRES // Set high resolution mode (16 bit data)
TIM:SCAL 1E-7 // Set time base
FORM REAL // Set REAL data format
FORM:BORD LSBF // Set little endian byte order
CHAN:DATA:POIN DMAX // Set sample range to memory data in displayed time range
SING;*OPC? // Start single acquisition
<-- 1
CHAN:DATA:HEAD? // Read header
<-- -4.9980E-07,5.0000E-07,5000,1 // Xstart, Xstop, record length in samples
CHAN:DATA? // Read channel data
<-- #520000>??[>??[>??[>??[>??[>??... // Binary block data,
// 4-byte floating point number/sample
```

15.2.1.4 Reading Waveform Data in Unsigned Integer Format

Read the channel header, the waveform conversion data, set the UINT binary data format and read the channel data.

Command description in: [Chapter 15.9.1, "Transfer of Waveform Data"](#), on page 400.
Return values are example data.

```
*RST
TIM:SCAL 1E-7
CHAN:DATA:POIN DMAX // Set data range
SING;*OPC?
<-- 1
CHAN:DATA:HEAD? // Read header
<-- -4.9980E-07,5.0000E-07,5000,1 // Xstart, Xstop, record length in samples
CHAN:DATA:YRES? // Read vertical resolution
<-- 8
CHAN:DATA:YOR? // Read voltage value for binary value 0
<-- -2.549999943E-2
```

```

CHAN:DATA:XOR?           // Read time of the first sample
<-- -4.998000058E-7
CHAN:DATA:XINC?         // Read time between two adjacent samples
<-- 2.000000023E-10
FORM UINT,8;FORM?      // Set data format to unsigned integer, 8 bit
<-- UINT,8
CHAN:DATA:YINC?        // Read voltage value per bit
<-- 1.999999949E-4
CHAN:DATA?             // Read channel data
<-- 128,125,120...     // 5000 bytes total
FORM UINT,16;FORM?    // Change data format to unsigned integer, 16 bit
<-- UINT,16
CHAN:DATA:YINC?        // Read voltage value per bit
<-- 7.812499803E-7
CHAN:DATA?             // Read channel data
<-- 32768,32000,30720... // 10000 bytes total

```

Note the following correlations:

- The number of received data values matches the number of samples indicated in the header.
- The time of the first sample (XORigin) matches the start time Xstart indicated in the header.
- The Y-increment adjusts to the data length defined in the data format (8 or 16 bit).

Data conversion

Definition: the sample numbers start with 0 and end with *record length - 1*.

Sample time

$$t_n = n * xIncrement + xOrigin$$

First sample: $t_0 = -4.998000058E-7$ (= Xstart)

Last sample: $t_{4999} = 4999 * 2E^{-10} - 4.998E^{-7} = 5.0 E^{-7}$ (= Xstop)

Sample value

$$Y_n = yOrigin + (yIncrement * byteValue_n)$$

The format UINT, 8 has the data range 0 to 255. The voltage value for byte value 128 is:

$$Y_n = -2.55E^{-2} + (2E^{-4} * 128) = 0.0001$$

The center of the display at position 0 div always has the byte value 127.5. The corresponding voltage value is:

$$Y_n = -2.55E^{-2} + (2E^{-4} * 127.5) = 0$$

8-bit and 16-bit data

At the end of the above example, the 8-bit waveform is read as 16-bit data, for example, *0xFF* is read *0xFF00*, or *0x1A* is read *0x1A00*. The *yOrigin* value is the same in both cases, but the *yIncrement* differs.

	8-bit data	16-bit data	Result
$yIncrement * byteValue_n$	$2e^{-4} * 128$	$7,8125E^{-7} * 32768$	0,0256 V
	$2e^{-4} * 125$	$7,8125E^{-7} * 32000$	0,025 V

In the reverse case, if a 16-bit waveform is read with 8-bit data format, data precision may be reduced. Data values are truncated, and only the more significant bits remain. For example, the 16-bit data *0xabcd* is read *0xab* in 8-bit format, and *cd* is lost.

15.2.2 Firmware Update

There are two ways to update the firmware on the instrument remotely. The web browser does not yet include firmware update functionality.

To prepare the remote update, configure the instrument's interface to Ethernet, USB TMC or USB VCP. Connect to the R&S RTB2000 using a socket connection, Visa or a terminal program.

15.2.2.1 Using MMEM:DATA + DIAGnostic:UPDate:LOAD

1. Send the firmware update file data to the internal storage of the instrument, for example:

```
:MMEM:DATA "/INT/RTB2004.FWU",blockdata\n
```

In SCPI, block data is composed of a header *#nm* containing the length of the data followed by the data in raw binary format. Here, *m* is the length of the data in byte, and *n* is the number of digits in *m*. The firmware update file has to be sent in a single transfer.

2. Start the firmware update:

```
:DIAG:UPD:LOAD "/INT/RTB2004.FWU"\n
```

The instrument loads, checks and executes the firmware update, and restarts.

3. After restart, delete the firmware update file in the internal storage:

```
:MMEM:DEL "/INT/RTB2004.FWU"\n
```

15.2.2.2 Using DIAGnostic:UPDdate:TRANsfer

1. Open a data transfer for the firmware update file, and check for errors:

```
:DIAG:UPD:TRAN:OPEN FIRM\n
```

```
:SYST:ERR:ALL?
```

2. Send the firmware update file data to the internal RAM of the instrument:

```
:DIAG:UPD:TRAN:DATA offset,checksum,blockdata\n
```

The offset parameter specifies the byte offset of the blockdata in the file. The checksum parameter is a CRC-16-CCITT type checksum calculated for the raw binary data in blockdata. In SCPI, block data is composed of a header #nm containing the length of the data followed by the data in raw binary format. Here, m is the length of the data in byte, and n is the number of digits in m.

The firmware update file can be split into multiple blocks, where each block has to be transferred with the above command. You can also transfer the file in a single block.

Example to send all data at once, without CRC:

```
DUT#sendRAW DIAG:UPD:TRAN:DATA 0,0,#822393104
DUT#sendFileContent "W:\RTB2004.FWU"
DUT#sendByte 10 //end of command '\n'
```
3. Close the transfer:

```
:DIAG:UPD:TRAN:CLOSE\n
```
4. Start the firmware update:

```
:DIAG:UPD:INST ""\n
```

The instrument checks and executes the firmware update.

15.2.3 Search

15.2.3.1 Searching for a Pulse of Specified Width

Search for positive pulses with pulse width $12 \pm 10 \mu\text{s}$ ($2 \mu\text{s}$ to $22 \mu\text{s}$).

Command description in: [Chapter 15.6.4, "Search"](#), on page 324.

Prerequisite: A pulse signal is connected to channel 2.

```
SEAR:STAT ON           // Turn on search
SEAR:COND WIDTH       // Select search condition
SEAR:SOUR CH2        // Configure search source
SEAR:TRIG:WIDT:POL POS // Configure search parameters: Polarity
SEAR:TRIG:WIDT:RANG WITH // Configure search parameters: Condition = within
SEAR:TRIG:WIDT:WIDT 12e-6 // Configure search parameters: Pulse width
SEAR:TRIG:WIDT:DELT 10e-6 // Configure search parameters: +/- delta
SEAR:RESD:SHOW ON    // Show result table
SEAR:RCO?            // Get number of search events found
<-- 1.400E+01
SEAR:RES:ALL?        // Get all search results
<-- 1,5.201200e-06,0,WIDTH,POSITIVE,1.220160e-05,2,4.120040e-05,0,WIDTH,
    POSITIVE,3.076800e-06,3,4.732480e-05,0,WIDTH,POSITIVE,9.127200e-06,4,
    6.499960e-05,0,WIDTH,POSITIVE,1.835160e-05,5,8.634920e-05,0,WIDTH,POSITIVE,
    3.052000e-06,6,1.293984e-04,0,WIDTH,POSITIVE,9.176800e-06,7,1.477228e-04,0,
    WIDTH,POSITIVE,3.052000e-06,8,1.623224e-04,0,WIDTH,POSITIVE,3.102000e-06,9,
```

```
1.684724e-04,0,WIDTH,POSITIVE,1.215160e-05,10,1.953216e-04,0,WIDTH,POSITIVE,
3.027200e-06,11,2.044716e-04,0,WIDTH,POSITIVE,6.052000e-06,12,2.252212e-04,0,
WIDTH,POSITIVE,3.052000e-06,13,2.435456e-04,0,WIDTH,POSITIVE,3.027200e-06,14,
2.496456e-04,0,WIDTH,POSITIVE,6.702000e-06
```

15.2.4 Function Generator

Configure and output a sine waveform.

Command description in: [Chapter 15.13.1, "Function Generator"](#), on page 508.

Prerequisite: To see the generated waveform on the oscilloscope, connect the "Gen" output to "Ch1" input.

```
*RST
WGEN:FUNC SIN           // Selects sine function
WGEN:VOLT 700E-3        // Sets the amplitude
WGEN:FREQ 1.00E+06      // Sets the frequency
WGEN:OUTP:LOAD R50      // Sets the user load
WGEN:OUTP 1             // Outputs the sine waveform
AUT                     // Autoscale to see the waveform
```

15.3 Common Commands

Common commands are described in the IEEE 488.2 (IEC 625-2) standard. These commands have the same effect and are employed in the same way on different devices. The headers of these commands consist of "*" followed by three letters. Many common commands are related to the Status Reporting System.

Available common commands:

*CAL?	286
*CLS	287
*ESE	287
*ESR?	287
*IDN?	287
*OPC	287
*OPT?	288
*PSC	288
*RST	288
*SRE	288
*STB?	289
*TRG	289
*WAI	289

*CAL?

Performs a self-alignment of the instrument and then generates a status response. Return values $\neq 0$ indicate an error.

Usage: Query only

***CLS**

Clear status

Sets the status byte (STB), the standard event register (ESR) and the `EVENT` part of the `QUESTIONABLE` and the `OPERATION` registers to zero. The command does not alter the mask and transition parts of the registers. It clears the output buffer.

Usage: Setting only

***ESE <Value>**

Event status enable

Sets the event status enable register to the specified value. The query returns the contents of the event status enable register in decimal form.

Parameters:

<Value> Range: 0 to 255

***ESR?**

Event status read

Returns the contents of the event status register in decimal form and then sets the register to zero.

Return values:

<Contents> Range: 0 to 255

Usage: Query only

***IDN?**

Identification

Returns the instrument identification.

Return values:

<ID> "Rohde&Schwarz,<device type>,<serial number>,<firmware version>"

Example: Rohde&Schwarz,RTB2004,1333.1005k04/900012,01.203

Usage: Query only

***OPC**

Operation complete

Sets bit 0 in the event status register when all preceding commands have been executed. This bit can be used to initiate a service request. The query writes a "1" into the output buffer when all preceding commands have been executed, which is useful for command synchronization.

*OPT?

Option identification query

Queries the options included in the instrument. For a list of all available options and their description, refer to the data sheet.

Return values:

<Options> The query returns a list of options. The options are returned at fixed positions in a comma-separated string. A zero is returned for options that are not installed.

Usage: Query only

*PSC <Action>

Power on status clear

Determines whether the contents of the `ENABLE` registers are preserved or reset when the instrument is switched on. Thus a service request can be triggered when the instrument is switched on, if the status registers ESE and SRE are suitably configured. The query reads out the contents of the "power-on-status-clear" flag.

Parameters:

<Action> 0 | 1
0
 The contents of the status registers are preserved.
1
 Resets the status registers.

*RST

Reset

Sets the instrument to a defined default status. The default settings are indicated in the description of commands.

Usage: Setting only

*SRE <Contents>

Service request enable

Sets the service request enable register to the indicated value. This command determines under which conditions a service request is triggered.

Parameters:

<Contents> Contents of the service request enable register in decimal form.
 Bit 6 (MSS mask bit) is always 0.
 Range: 0 to 255

***STB?**

Status byte query

Reads the contents of the status byte in decimal form.

Usage: Query only

***TRG**

Trigger

Triggers all actions waiting for a trigger event. In particular, *TRG generates a manual trigger signal. This common command complements the commands of the TRIGger subsystem.

Usage: Event

***WAI**

Wait to continue

Prevents servicing of the subsequent commands until all preceding commands have been executed and all signals have settled (see also command synchronization and *OPC).

Usage: Event

15.4 Waveform Setup

- [Automatic Setup](#).....290
- [Starting and Stopping Acquisition](#).....290
- [Vertical Settings](#).....291
- [Passive Probes](#).....298
- [Horizontal Settings](#).....299
- [Acquisition Settings](#).....301
- [Waveform Data](#).....306

15.4.1 Automatic Setup

AUToscale

Performs an autoset process for analog channels: analyzes the enabled analog channel signals, and adjusts the horizontal, vertical, and trigger settings to display stable waveforms

Usage: Event
Asynchronous command

15.4.2 Starting and Stopping Acquisition

RUN.....	290
RUNContinuous.....	290
SINGLE.....	290
RUNSingle.....	290
ACQUIRE:NSINGLE:COUNT.....	290
STOP.....	291
ACQUIRE:STATE.....	291

RUN

RUNContinuous

Starts the continuous acquisition.

Usage: Event
Asynchronous command

SINGLE

RUNSingle

Starts a defined number of acquisitions. The number of acquisitions is set with [ACQUIRE:NSINGLE:COUNT](#).

Usage: Event
Asynchronous command

ACQUIRE:NSINGLE:COUNT <NSingleCount>

Sets the number of waveforms acquired with [RUNSingle](#).

Parameters:

<NSingleCount>	Number of waveforms.
Range:	1 to maximum number that depends on the record length.
*RST:	1

STOP

Stops the running acquisition.

Usage: Event
Asynchronous command

ACQUIRE:STATE

Sets or queries the acquisition state of the instrument.

Parameters:

<AcquisitionState> RUN | STOPping | COMplete | BREak

RUN

Set: Starts the acquisition.

Read: The acquisition is running.

STOPping

Set: Stops the acquisition when it is finished.

Read: Acquisition is stopped.

COMplete

Set: Not available.

Read: The current acquisition is finished and completed.

BREak

Set: Immediate interrupt of current acquisition.

Read: acquisition is finished but interrupted.

15.4.3 Vertical Settings

CHANnel<m>:STATe.....	292
CHANnel<m>:AON.....	292
CHANnel<m>:AOFF.....	292
CHANnel<m>:SCALE.....	292
CHANnel<m>:RANGE.....	292
CHANnel<m>:POSITION.....	293
CHANnel<m>:OFFSet.....	293
CHANnel<m>:COUPling.....	293
CHANnel<m>:BANDwidth.....	294
CHANnel<m>:POLarity.....	294
CHANnel<m>:SKEW.....	295
CHANnel<m>:ZOFFset[VALue].....	295
CHANnel<m>:WCOLor.....	295
CHANnel<m>:OVERload.....	296
CHANnel<m>:THReshold.....	296
CHANnel<m>:THReshold:FINDlevel.....	297
CHANnel<m>:THReshold:HYSteresis.....	297
CHANnel<m>:LABel.....	297
CHANnel<m>:LABel:STATe.....	297

CHANnel<m>:STATe <State>

Switches the channel signal on or off.

Suffix:

<m> 1..4
Selects the input channel. The number of channels depends on the instrument.

Parameters:

<State> ON | OFF

CHANnel<m>:AON

Switches all analog channels on.

Suffix:

<m> The suffix is irrelevant.

Usage: Event

CHANnel<m>:AOFF

Switches all analog channels off.

Suffix:

<m> The suffix is irrelevant.

Usage: Event

CHANnel<m>:SCALE <Scale>

Sets the vertical scale for the indicated channel.

Suffix:

<m> 1..4
Selects the input channel. The number of channels depends on the instrument.

Parameters:

<Scale> Scale value, given in Volts per division.
Range: 1e-3 to 10 (without probe attenuation)
*RST: 5e-3
Default unit: V/div

CHANnel<m>:RANGE <Range>

Sets the voltage range across the all vertical divisions of the diagram. Use the command alternatively instead of [CHANnel<m>:SCALE](#).

Suffix:

<m> 1..4
 Selects the input channel. The number of channels depends on the instrument.

Parameters:

<Range> Voltage range value
 Range: 8e-3 to 80 (without probe attenuation)
 *RST: 40e-3
 Default unit: V

CHANnel<m>:POSition <Position>

Sets the vertical position of the waveform in divisions. While the offset sets a voltage, position is a graphical setting given in divisions.

Suffix:

<m> 1..4
 Selects the input channel. The number of channels depends on the instrument.

Parameters:

<Position> Graphical position
 Range: -5 to 5
 *RST: 0
 Default unit: div

CHANnel<m>:OFFSet <Offset>

Sets the offset voltage, which is subtracted to correct an offset-affected signal.

Suffix:

<m> 1..4
 Selects the input channel. The number of channels depends on the instrument.

Parameters:

<Offset> Offset value
 Range: Depend on vertical scale and probe attenuation.
 Increment: Depends on vertical scale and probe attenuation.
 *RST: 0
 Default unit: V

CHANnel<m>:COUPling <Coupling>

Selects the connection of the indicated channel signal - coupling and termination.

Suffix:

<m> 1..4
Selects the input channel. The number of channels depends on the instrument.

Parameters:

<Coupling> DCLimit | ACLimit | GND
DCLimit
DC coupling passes the input signal unchanged.
ACLimit
Removes the DC offset voltage from the input signal.
GND
Connection to a virtual ground. All channel data is set to 0 V.

CHANnel<m>:BANDwidth <BandwidthLimit>

Selects the bandwidth limit for the indicated channel.

Suffix:

<m> 1..4
Selects the input channel. The number of channels depends on the instrument.

Parameters:

<BandwidthLimit> FULL | B20
FULL
Use full bandwidth.
B20
Limit to 20 MHz. Higher frequencies are removed to reduce noise.
 *RST: FULL

CHANnel<m>:POLarity <Polarity>

Turns the inversion of the signal amplitude on or off. To invert means to reflect the voltage values of all signal components against the ground level. Inversion affects only the display of the signal but not the trigger.

Suffix:

<m> 1..4
Selects the input channel. The number of channels depends on the instrument.

Parameters:

<Polarity> NORMal | INVerted
 *RST: NORM

CHANnel<m>:SKEW <Skew>

Sets a delay for the selected channel.

Deskew compensates delay differences between channels caused by the different length of cables, probes, and other sources. Correct deskew values are important for accurate triggering.

Suffix:

<m> 1..4
Selects the input channel. The number of channels depends on the instrument.

Parameters:

<Skew> Deskew value
Default unit: s

CHANnel<m>:ZOFFset[:VALue] <ZeroOffset>

Sets the zero offset.

Differences in DUT and oscilloscope ground levels may cause larger zero errors affecting the waveform. If the DUT is ground-referenced, the "Zero Offset" corrects the zero error and sets the probe to the zero level.

You can assess the zero error by measuring the mean value of a signal that should return zero.

Suffix:

<m> 1..4
Selects the input channel. The number of channels depends on the instrument.

Parameters:

<ZeroOffset> *RST: 0
Default unit: V

CHANnel<m>:WCOLor <WaveformColor>

Selects the color scale for the waveform color. Each scale comprises a set of colors, where each color represents a certain frequency of occurrence.

Suffix:

<m> 1..4
Selects the input channel. The number of channels depends on the instrument.

Parameters:

<WaveformColor> TEMPerature | RAINbow | FIRE | DEFault

TEMPerature

Temperature colors. Blue corresponds to rare occurrences of the samples, while white indicates frequent ones.

RAINbow

Rainbow colors. Blue corresponds to rare occurrences of the samples, while red indicates frequent ones.

FIRE

Fire colors. Yellow corresponds to rare occurrences of the samples, while red indicates frequent ones.

DEFault

Default monochrome color.

*RST: DEF

CHANnel<m>:OVERload <Overload>

Retrieves the overload status of the specified channel from the status bit. When the overload problem is solved, the command resets the status bit.

Suffix:

<m> 1..4
Selects the input channel. The number of channels depends on the instrument.

Parameters:

<Overload> ON | OFF
Use OFF to reset the overload status bit.
*RST: OFF

Example:

CHANnel2:OVERload?
Queries the overload status of channel 2.
CHANnel2:OVERload OFF
Resets the overload status bit.

CHANnel<m>:THReshold <Threshold>

Threshold value for digitization of analog signals. If the signal value is higher than the threshold, the signal state is high (1 or true for the Boolean logic). Otherwise, the signal state is considered low (0 or false) if the signal value is below the threshold.

Suffix:

<m> 1..4
Selects the input channel. The number of channels depends on the instrument.

Parameters:

<Threshold> Often used values are:
TTL: 1.4 V
ECL: -1.3 V
CMOS: 2.5 V
Default unit: V

CHANnel<m>:THReshold:FINDlevel

The instrument analyzes the channel and sets the threshold for digitization.

Suffix:

<m> 1..4
Selects the input channel. The number of channels depends on the instrument.

Parameters:

<FindLevel>

Usage: Event

CHANnel<m>:THReshold:HYSTeresis <ThresholdHysteresis>

Defines the size of the hysteresis to avoid the change of signal states due to noise.

Suffix:

<m> 1..4
Selects the input channel. The number of channels depends on the instrument.

Parameters:

<ThresholdHysteresis>SMAL | MEDium | LARGe

Values correspond to the vertical scale

*RST: SMAL

CHANnel<m>:LABel <Label>

Specifies a name for the selected channel.

Suffix:

<m> 1..4
Selects the input channel. The number of channels depends on the instrument.

Parameters:

<Label> String value

String with max. 8 characters, only ASCII characters can be used

CHANnel<m>:LABel:STATe

Shows or hides the channel name.

Suffix:

<m> 1..4
Selects the input channel. The number of channels depends on the instrument.

Parameters:

<State> ON | OFF
 *RST: OFF

15.4.4 Passive Probes

PROBe<m>:SETup:ATTenuation:UNIT.....	298
PROBe<m>:SETup:ATTenuation:MANual.....	298
PROBe<m>:SETup:GAIN:UNIT.....	298
PROBe<m>:SETup:GAIN:MANual.....	299

PROBe<m>:SETup:ATTenuation:UNIT <Unit>

Selects the unit that the probe can measure.

Suffix:

<m> 1..4
 Selects the input channel. The number of channels depends on the instrument.

Parameters:

<Unit> V | A

PROBe<m>:SETup:ATTenuation:MANual <ManualAttenuation>

Sets the attenuation of the probe.

Suffix:

<m> 1..4
 Selects the input channel. The number of channels depends on the instrument.

Parameters:

<ManualAttenuation> Range: 0.0001 to 10000
 *RST: 1

PROBe<m>:SETup:GAIN:UNIT <Unit>

Selects the unit that the probe can measure.

Suffix:

<m> 1..4
 Selects the input channel. The number of channels depends on the instrument.

Parameters:

<Unit> V | A

PROBe<m>:SETup:GAIN:MANual <ManualGain>

Sets the gain of the probe. The gain is the reciprocal of the attenuation ([PROBe<m>:SETup:ATTenuation:MANual](#))

Suffix:

<m> 1..4
Selects the input channel. The number of channels depends on the instrument.

Parameters:

<ManualGain> Range: 0.0001 to 10000

15.4.5 Horizontal Settings

TIMebase:SCALE	299
TIMebase:POSition	299
TIMebase:REFerence	300
TIMebase:ACQTime	300
TIMebase:RANGe	300
TIMebase:DIVisions?	300
TIMebase:RATime?	300

TIMebase:SCALE <TimeScale>

Sets the horizontal scale for all channel and math waveforms.

Parameters:

<TimeScale> Range: 1e-9 to 50; lower limits are possible if zoom or FFT is enabled.
Increment: 1e-9
*RST: 100e-6
Default unit: s/div

TIMebase:POSition <Offset>

Defines the trigger position, the time distance from the trigger point to the reference point (trigger offset). The trigger point is the zero point of the diagram. Changing the horizontal position, you can move the trigger, even outside the screen.

See also: [TIMebase:REFerence](#) on page 300

Parameters:

<Offset> Range: Depends on time base setting
Increment: 0.01
*RST: 0
Default unit: s

TIMEbase:REFerence <ReferencePoint>

Defines the time reference point in the diagram. The reference point is the rescaling center of the time scale on the screen. If you modify the time scale, the reference point remains fixed on the screen, and the scale is stretched or compressed to both sides of the reference point.

The reference point defines which part of the waveform is shown. By default, the reference point is displayed in the center of the window, and you can move it to the left or right.

See also: [TIMEbase:POSition](#) on page 299

Parameters:

<ReferencePoint> 8.33 | 50 | 91.67
 8.33 = left position (1 div); 50 = middle position; 91.67 = right position (11 div).
 *RST: 50
 Default unit: %

TIMEbase:ACQTime <AcquisitionTime>**TIMEbase:RANGe** <AcquisitionTime>

Defines the time of one acquisition, that is the time across the 10 divisions of the diagram: $Timebase\ Scale * 10$.

Parameters:

<AcquisitionTime> Range and increment depend on time base and other settings
 Range: 250e-12 to 500
 Increment: 1e-12
 Default unit: s

TIMEbase:DIVisions?

Queries the number of horizontal divisions on the screen.

Return values:

<HorizDivCount> Returns 12 divisions.

Usage: Query only

TIMEbase:RATime?

Queries the real acquisition time used in the hardware. If FFT analysis is performed, the value can differ from the adjusted acquisition time ([TIMEbase:ACQTime](#)).

Return values:

<HWAcqTime> Range: Depends on various settings
 Default unit: s

Usage: Query only

15.4.6 Acquisition Settings

ACQUIRE:POINTS:AUTOMATIC.....	301
ACQUIRE:POINTS[:VALUE].....	301
CHANNEL<m>:TYPE.....	302
ACQUIRE:TYPE.....	302
CHANNEL<m>:ARITHMETICS.....	303
ACQUIRE:PEAKDETECT.....	303
ACQUIRE:HRESOLUTION.....	303
ACQUIRE:NSINGLE:COUNT.....	304
ACQUIRE:AVERAGER:COUNT.....	304
ACQUIRE:AVERAGER:RESET.....	304
ACQUIRE:AVERAGER:COMPLETE?.....	304
TIMEBASE:ROLL:AUTOMATIC.....	304
TIMEBASE:ROLL:MTIME.....	305
ACQUIRE:INTERPOLATE.....	305
ACQUIRE:POINTS:ARATE?.....	305
ACQUIRE:SRATE?.....	305

ACQUIRE:POINTS:AUTOMATIC <AutoRecordLength>

Enables or disables the automatic record length. The instrument sets a value that fits to the selected timebase.

If you set a specific value with `ACQUIRE:POINTS[:VALUE]`, the automatic assignment of a record length is turned off.

Parameters:

<AutoRecordLength> ON | OFF

Example:

```
ACQ:POIN:AUT ON
TIM:SCAL 1e-9
ACQ:POIN?;:SYST:ERR:ALL?
-> received 10000;0,"No error"
TIM:SCAL 5e-3
ACQ:POIN?;:SYST:ERR:ALL?
-> received 20000000;0,"No error"
```

ACQUIRE:POINTS[:VALUE]

Defines a record length value, the number of recorded waveform points in a segment.

The command turns `ACQUIRE:POINTS:AUTOMATIC` OFF.

If `ACQUIRE:POINTS:AUTOMATIC` is turned ON, the query `ACQUIRE:POINTS?` returns the automatically set record length.

Each predefined record length corresponds to a maximum number of history segments, which are stored in the instrument's memory. If option R&S RTB-K15 is installed, you can display the history segments.

Available record length values are:

- 10 kSa (13107 history segments)
- 20 kSa (13107 history segments)
- 50 kSa (3276 history segments)
- 100 kSa (2621 history segments)
- 200 kSa (1456 history segments)
- 500 kSa (319 history segments)
- 1 MSa (319 history segments)
- 2 MSa (159 history segments)
- 5 MSa (40 history segments)
- 10 MSa (32 history segments)
- 20 MSa (16 history segments)

Parameters:

<RecordLength> Record length in Samples.
If the entered value differs from the predefined values, the instrument sets the closest value.

CHANnel<m>:TYPE <DecimationMode>

Selects the method to reduce the data stream of the ADC to a stream of waveform points with lower sample rate.

Suffix:

<m> 1..4
The command affects all channels regardless of the indicated channel number. The suffix can be omitted.

Parameters:

<DecimationMode> SAMPLE | PDETECT | HRESOLUTION

SAMPLE

Input data is acquired with a sample rate which is aligned to the time base (horizontal scale) and the record length.

PDETECT

Peak Detect: the minimum and the maximum of n samples in a sample interval are recorded as waveform points.

HRESOLUTION

High resolution: The average of n sample points is recorded as waveform point.

*RST: SAMPLE

ACQUIRE:TYPE <AcquisitionType>

Sets the type of the acquisition mode.

Parameters:

<AcquisitionType> REFRESH | AVERAGE | ENVELOPE

REFresh

The acquisitions are displayed as they are done.

AVERage

The acquisitions are averaged.

ENVELOpe

The envelope of a repetitive signal is shown, representing the borders in which the signal occurs.

CHANnel<m>:ARITHmetics <TrArith>

Selects the method to build the resulting waveform from several consecutive acquisitions of the signal.

Suffix:

<m>

1..4

The command affects all channels regardless of the indicated channel number. The suffix can be omitted.

Parameters:

<TrArith>

OFF | ENVELOpe | AVERage

OFF

The data of the current acquisition is recorded according to the decimation settings.

ENVELOpe

Detects the minimum and maximum values in a sample interval over a number of acquisitions.

AVERage

Calculates the average from the data of the current acquisition and a number of acquisitions before. The number of used acquisitions is set with [ACQUIRE: AVERage: COUNT](#).

*RST: OFF

ACQUIRE:PEAKdetect <PeakDetect>

Enables or disables the peak detect acquisition mode.

You can use this command alternatively to [CHANnel<m>: TYPE](#).

Parameters:

<PeakDetect>

AUTO | OFF

*RST: OFF

ACQUIRE:HRESolution <HighRes>

Enables or disables the high resolution acquisition mode.

You can use this command alternatively to [CHANnel<m>: TYPE](#).

Parameters:

<HighRes> AUTO | OFF
 *RST: OFF

ACQUIRE:NSINGLE:COUNT <NSingleCount>

Sets the number of waveforms acquired with [RUNSingle](#).

Parameters:

<NSingleCount> Number of waveforms.
 Range: 1 to maximum number that depends on the record length.
 *RST: 1

ACQUIRE:AVERAGE:COUNT

Defines the number of waveforms used to calculate the average waveform. The higher the number, the better the noise is reduced.

Parameters:

<AverageCount> Range: 2 to 100,000
 *RST: 2

ACQUIRE:AVERAGE:RESET

Deletes the waveform and restarts the average calculation.

Usage: Event

ACQUIRE:AVERAGE:COMPLETE?

Returns the state of averaging.

Return values:

<AverageComplete> 0 | 1

0

The number of acquired waveforms is less than the number required for average calculation. See [ACQUIRE:AVERAGE:COUNT](#) on page 304.

1

The instrument acquired a sufficient number of waveforms to determine the average.

Usage: Query only

TIMEBASE:ROLL:AUTOMATIC <AutomaticRoll>

Enables the automatic roll mode. The instrument switches to roll mode if the timebase is equal or slower than the roll mode limit defined with [TIMEBASE:ROLL:MTIME](#).

Parameters:

<AutomaticRoll> ON | OFF
 *RST: OFF

TIMEbase:ROLL:MTIME <MinTimeBase>

The roll mode is enabled automatically if the time base exceeds the `MinTimeBase`, and if `TIMEbase:ROLL:AUTomatic` on page 304 is set ON.

Parameters:

<MinTimeBase> Limit value for roll mode enabling.
 *RST: 500e-3
 Default unit: s/div

ACQUIRE:INTERpolate <InterpolationType>

Defines the interpolation mode.

See also: "[Interpolation](#)" on page 55

Parameters:

<InterpolationType> SINX | LINEar | SMHD

LINEar
 Linear interpolation between two adjacent sample points.

SINX
 Interpolation by means of a $\sin(x)/x$ curve.

SMHD
 Sample & hold causes a histogram-like interpolation.

*RST: SINX

ACQUIRE:POINTS:ARATE?

Retrieves the sample rate of the ADC, that is the number of points that are sampled by the ADC in one second.

Return values:

<ACDsampleRate> ADC sample rate
 Default unit: Hz

Usage: Query only

ACQUIRE:SRATE? <SampleRate>

Returns the sample rate, that is the number of recorded waveform samples per second.

Parameters:

<SampleRate> Default unit: Sa/s

Usage: Query only

15.4.7 Waveform Data

Use the following commands are described in [Chapter 15.9.1.2, "Analog Channels"](#), on page 402:

- [FORMat \[: DATA \]](#) on page 400
- [CHANnel<m>: DATA?](#) on page 402
- [CHANnel<m>: DATA: HEADer?](#) on page 403
- [CHANnel<m>: DATA: POINTs](#) on page 403
- [CHANnel<m>: DATA: ENVELOpe?](#) on page 404
- [CHANnel<m>: DATA: ENVELOpe: HEADer?](#) on page 405
- [CHANnel<m>: DATA: XINCrement?](#) on page 410
- [CHANnel<m>: DATA: XORigin?](#) on page 409
- [CHANnel<m>: DATA: YINCrement?](#) on page 411
- [CHANnel<m>: DATA: YORigin?](#) on page 410
- [CHANnel<m>: DATA: YRESolution?](#) on page 411
- [CHANnel<m>: DATA: ENVELOpe: XINCrement?](#) on page 410
- [CHANnel<m>: DATA: ENVELOpe: XORigin?](#) on page 409
- [CHANnel<m>: DATA: ENVELOpe: YINCrement?](#) on page 411
- [CHANnel<m>: DATA: ENVELOpe: YORigin?](#) on page 410
- [CHANnel<m>: DATA: ENVELOpe: YRESolution?](#) on page 411

15.5 Trigger

- [General Trigger Settings](#)..... 306
- [Edge Trigger](#)..... 308
- [Width Trigger](#)..... 310
- [Video/TV Trigger](#)..... 312
- [Pattern Trigger](#)..... 313
- [Timeout Trigger](#)..... 316
- [Serial Bus](#)..... 316

15.5.1 General Trigger Settings

This section describes general trigger commands that are independent of the trigger type.

- [TRIGger:A:MODE](#)..... 307
- [TRIGger:A:SOURce](#)..... 307
- [TRIGger:A:TYPE](#)..... 307
- [TRIGger:A:HOLDoff:MODE](#)..... 308
- [TRIGger:A:HOLDoff:TIME](#)..... 308

TRIGger:A:MODE <TriggerMode>

Sets the trigger mode. The trigger mode determines the behavior of the instrument if no trigger occurs.

Parameters:

<TriggerMode> AUTO | NORMAl

AUTO

The instrument triggers repeatedly after a time interval if the trigger conditions are not fulfilled. If a real trigger occurs, it takes precedence.

NORMAl

The instrument acquires a waveform only if a trigger occurs.

*RST: AUTO

TRIGger:A:SOURce <Source>

Sets the trigger source for the selected A trigger type.

Parameters:

<Source> CH1 | CH2 | CH3 | CH4 | EXTernalog | LINE | SBUS1 | SBUS2 | D0..D15

CH1 | CH2 | CH3 | CH4

One of the analog input channels is the trigger source. Available channels depend on the instrument type.

EXTernalog

External trigger input on the front panel

LINE

AC power supply line for the line trigger

SBUS1 | SBUS2

Serial bus 1 or 2

Requires at least one protocol option for serial bus (R&S RTB-K1 to K3)

D0..D15

Digital channels D0 to D15, can be used as trigger sources for edge, width, timeout and pattern trigger. Require MSO option R&S RTB-B1.

TRIGger:A:TYPE <Type>

Sets the trigger typer.

Parameters:

<Type> EDGE | WIDTHh | TV | BUS | LOGic | LINE

EDGE

Edge trigger

WIDTHh

Width trigger

TV

Video trigger

BUS

Requires at least one protocol option for serial bus (R&S RTB-K1 to K3)

LOGic

Pattern trigger, logic trigger

LINE

Trigger on power supply line

TRIGger:A:HOLDoff:MODE <HoldOffMode>

Enables or disables the holdoff time.

Parameters:

<HoldOffMode> TIME | OFF
 *RST: Off

TRIGger:A:HOLDoff:TIME <HoldOffTime>

Defines the holdoff time. The next trigger occurs only after the holdoff time has passed.

Parameters:

<HoldOffTime> Default unit: s

15.5.2 Edge Trigger

TRIGger:A:EDGE:SLOPe.....	308
TRIGger:A:LEVel<n>[:VALue].....	309
TRIGger:A:FINDlevel.....	309
TRIGger:A:EDGE:COUPling.....	309
TRIGger:A:HYSteresis.....	309
TRIGger:A:LEVel<n>:HYSteresis.....	310
TRIGger:A:EDGE:FILTer:HFReject.....	310
TRIGger:A:EDGE:FILTer:NREJect.....	310

TRIGger:A:EDGE:SLOPe <Slope>

Sets the slope for the edge trigger.

Parameters:

<Slope> POSitive | NEGative | EITHer

POSitive
Rising edge, a positive voltage change

NEGative
Falling edge, a negative voltage change

EITHer
The rising as well as the falling edge

*RST: POSitive

TRIGger:A:LEVel<n>[:VALue] <Level>

Sets the trigger threshold voltage for edge, width, and timeout trigger.

Suffix:

<n> 1..5
Selects the trigger input. 1..4 select the corresponding analog channel, 5 is the external trigger input. The number of channels depends on the instrument.

Parameters:

<Level> Range: Depends on vertical scale.
Default unit: V

TRIGger:A:FINDlevel

Sets the trigger level to 50% of the signal amplitude.

Usage: Event

TRIGger:A:EDGE:COUPLing <Coupling>

Sets the coupling for the trigger source.

Parameters:

<Coupling> DC | AC | LFReject
DC
Direct current coupling. The trigger signal remains unchanged.
AC
Alternating current coupling. A highpass filter removes the DC offset voltage from the trigger signal.
LFReject
Sets the trigger coupling to high frequency. A 15 kHz highpass filter removes lower frequencies from the trigger signal. Use this mode only with very high frequency signals.
 *RST: DC

TRIGger:A:HYSTeresis <Hysteresis>

Sets a hysteresis range around the trigger level. Hysteresis avoids unwanted trigger events caused by noise oscillation around the trigger level. The automatic, small, medium, large hysteresis values depend on the vertical scale.

On instruments with 1 GHz bandwidth, you can also set the hysteresis to user-defined values using [TRIGger:A:LEVel<n>:HYSTeresis](#).

Parameters:

<Hysteresis> AUTO | SMALl | MEDium | LARGE
 *RST: AUTO

TRIGger:A:LEVel<n>:HYSTeresis <LevelHysteresis>

Sets the hysteresis value for the trigger level on instruments with 1 GHz bandwidth.

Parameters:

<LevelHysteresis> Default unit: DIV

TRIGger:A:EDGE:FILTer:HFReject <State>

Enables or disables an additional 5 kHz lowpass filter in the trigger path. This filter removes higher frequencies and is available with AC and DC coupling.

To foltter out higher frequencies, you can use either this command or [TRIGger:A:EDGE:FILTer:NREJect](#).

Parameters:

<State> ON | OFF
 *RST: OFF

TRIGger:A:EDGE:FILTer:NREJect <State>

Turns an additional 100 MHz lowpass filter in the trigger path on or off. This filter removes higher frequencies and is available with AC and DC coupling.

To foltter out higher frequencies, you can use either this command or [TRIGger:A:EDGE:FILTer:HFReject](#).

Parameters:

<State> ON | OFF
 *RST: OFF

15.5.3 Width Trigger

To set the trigger level (threshold), use:

- [TRIGger:A:LEVel<n>\[:VALue\]](#) on page 309
[CHANnel<m>:THReshold](#) on page 296
- [TRIGger:A:FINDlevel](#) on page 309
[CHANnel<m>:THReshold:FINDlevel](#) on page 297
- [CHANnel<m>:THReshold:HYSTeresis](#) on page 297

TRIGger:A:WIDTH:POLarity	311
TRIGger:A:WIDTH:RANGe	311
TRIGger:A:WIDTH:WIDTH	311
TRIGger:A:WIDTH:DELTA	312

TRIGger:A:WIDTh:POLarity <Polarity>

Sets the polarity of the pulse.

Parameters:

<Polarity> POSitive | NEGative

POSitive

Positive going pulse, the width is defined from the rising to the falling slopes.

NEGative

Negative going pulse, the width is defined from the falling to the rising slopes.

*RST: POSitive

TRIGger:A:WIDTh:RANGe <RangeMode>

Defines how the measured pulse width is compared with the given limits.

Parameters:

<RangeMode> WITHin | OUTSide | SHORter | LONGer

WITHin | OUTSide

Triggers on pulses inside or outside a range defined by *time ± delta*. The time is specified with `TRIGger:A:WIDTh:WIDTh`, the range around is defined with `TRIGger:A:WIDTh:DELTA`. To trigger on an exact value ("Width =" or "Width #", set the range to 0 ("Variation", `TRIGger:A:WIDTh:DELTA`).

SHORter | LONGer

Triggers on pulses shorter or longer than a time set with `TRIGger:A:WIDTh:WIDTh`.

*RST: LONGer

TRIGger:A:WIDTh:WIDTh <Time1>

For the ranges WITHin and OUTSide (defined using `TRIGger:A:WIDTh:RANGe`), the <Time1> defines the center of a range which is defined by the limits \pm <Delta> (set with `TRIGger:A:WIDTh:DELTA`).

For the ranges SHORter and LONGer, the width defines the maximum and minimum pulse width, respectively.

Parameters:

<Time1> Center value, maximum value or minimum value depending on the defined range type.

Range: 20E-9 to 6.87194685440

Increment: Depends on the <Time1> value

*RST: 20E-9

TRIGger:A:WIDTH:DELTA <Delta>

Defines a variation range around the width value specified using [TRIGger:A:WIDTH:WIDTH](#).

Parameters:

<Delta> Variation $\pm\Delta t$
 Range: Minimum is 0. Maximum depends on the defined pulse width (TRIG:A:WIDTH:WITDH).

15.5.4 Video/TV Trigger

TRIGger:A:TV:STANdard	312
TRIGger:A:TV:POLarity	312
TRIGger:A:TV:FIELD	313
TRIGger:A:TV:LINE	313

TRIGger:A:TV:STANdard <Standard>

Selects the color television standard.

Parameters:

<Standard> PAL | NTSC | SECam | PALM | I576 | P720 | P1080 | I1080
 PALM = PAL-M
 I576 = SDTV 576i (PAL and SECAM)
 P720 | P1080 = HDTV 720/1080p (progressive scanning)
 I1080 = HDTV 1080i (interlaced scanning)
 *RST: PAL

TRIGger:A:TV:POLarity <Polarity>

Selects the polarity of the signal. Note that the sync pulse has the opposite polarity. The edges of the sync pulses are used for triggering,

See also: "[Signal](#)" on page 68

Parameters:

<Polarity> POSitive | NEGative
POSitive
 If the video modulation is positive, the sync pulses are negative.
NEGative
 If the modulation is negative, sync pulses are positive.
 *RST: NEGative

TRIGger:A:TV:FIELD <Field>

Sets the trigger on the beginning of the video signal fields, or on the beginning of video signal lines.

Parameters:

<Field>

EVEN | ODD | ALL | LINE | ALINe

EVEN | ODD

Triggers only on the field start of even or odd fields. Only available for interlaced scanning.

ALL

All fields, triggers on the frame start (progressive scanning) or any field start (interlaced scanning).

LINE

Triggers on the beginning of a specified line in any field. The line number is set with [TRIGger:A:TV:LINE](#).

ALINe

Triggers on the beginning of all video signal lines.

*RST: ALL

TRIGger:A:TV:LINE <Line>

Sets an exact line number if [TRIGger:A:TV:FIELD](#) is set to LINE.

Parameters:

<Line>

Range: 1 to 525 (NTSC, PAL-M); 625 (PAL, SECAM, SDTV I-576); 750 (HDTV P720); 1125 (HDTV I1080, HDTV P1080)

Increment: 1

*RST: 1

15.5.5 Pattern Trigger

- [Pattern Definition](#).....313
- [Time Limitation](#).....314

15.5.5.1 Pattern Definition[TRIGger:A:PATtern:SOURce](#)..... 313[TRIGger:A:PATtern:FUNction](#).....314[TRIGger:A:PATtern:CONDition](#)..... 314**TRIGger:A:PATtern:SOURce** <SourceString>

Sets the state for each channel.

Parameters:

<SourceString>

String containing 0, 1, or X for each channel.

1: high, the signal voltage is higher than the trigger level.
 0: low, the signal voltage is lower than the trigger level.
 X: Don't care. the channel does not affect the trigger.
 Without MSO option R&S RTB-B1, the pattern has 4 or 2 bits, depending on the number of channels: <C1><C2>[<C3><C4>].
 With MSO option, the pattern has 20 or 18 bits:
 <C1><C2>[<C3><C4>]<D0><D1><D2>...<D15>.

Example: Without MSO option:
`TRIG:A:PATT:SOUR "1X10"`
 C1 and C3 is set to high, C4 to low, and C2 does not matter (don't care).

Example: With MSO option:
`TRIG:A:PATT:SOUR "XXXX111101010011XXXX"`
 Analog channels C1 to C4 do not matter (don't care). Digital channels D0 to D11 are set to high or low, D12 to D15 do not matter.

TRIGger:A:PATtern:FUNCtion <Function>

Sets the logical combination of the channel states .

Parameters:

<Function>

AND | OR

AND

The required states of all channels must appear in the input signal at the same time.

OR

At least one of the channels must have the required state.

*RST: AND

TRIGger:A:PATtern:CONDition <ConditionString>

Defines whether the instrument triggers on fulfillment of the logical condition, or on violation.

Parameters:

<ConditionString>

""TRUE"" | ""FALSE""

String parameter

*RST: ""TRUE""

15.5.5.2 Time Limitation

TRIGger:A:PATtern:MODE.....	315
TRIGger:A:PATtern:WIDTh:RANGe.....	315
TRIGger:A:PATtern:WIDTh[:WIDTh].....	315
TRIGger:A:PATtern:WIDTh:DELTA.....	316

TRIGger:A:PATtern:MODE <PatternMode>

Disables the time limitation or sets the time comparison mode.

Parameters:

<PatternMode> OFF | TIMEout | WIDTH

OFF

Disables the time limitation.

TIMEout

Defines how long at least the result of the state pattern condition must be true or false.

WIDTH

Defines a time range for keeping up the true result of the pattern condition. The range is defined using `TRIGger:A:PATtern:WIDTH:RANGe`.

TRIGger:A:PATtern:WIDTH:RANGe <PatternRange>

Selects how the time limit for the pattern condition is defined.

The time is specified using `TRIGger:A:PATtern:WIDTH[:WIDTH]`, the range around is specified using `TRIGger:A:PATtern:WIDTH:DELTA`.

Parameters:

<PatternRange> WITHin | OUTSide | SHORter | LONGer

WITHin

Triggers if the pattern condition remains unchanged longer than *Time - Delta* and shorter than *Time + Delta*.

OUTSide

Triggers if the pattern condition remains unchanged either shorter than *Time - Delta* or longer than *Time + Delta*.

SHORter | LONGer

Triggers if the pattern condition changes before or after the specified time.

TRIGger:A:PATtern:WIDTH[:WIDTH] <PatternWidth>

For the ranges WITHin and OUTSide, the <PatternWidth> defines the center of a range which is defined by the limits \pm <Delta>.

For the ranges SHORter and LONGer, the pattern width defines the maximum and minimum values, respectively.

Parameters:

<PatternWidth> Default unit: s

TRIGger:A:PATtern:WIDTh:DELTA <PatternDelta>

Defines a range around the pattern width value specified using **TRIGger:A:PATtern:WIDTh[:WIDTh]**.

Parameters:

<PatternDelta> Default unit: s

15.5.6 Timeout Trigger

To set the trigger level (threshold), use:

- **TRIGger:A:LEVel<n>[:VALue]** on page 309
CHANnel<m>:THReshold on page 296
- **TRIGger:A:FINDlevel** on page 309
CHANnel<m>:THReshold:FINDlevel on page 297
- **CHANnel<m>:THReshold:HYSTeresis** on page 297

TRIGger:A:TIMeout:RANGe	316
TRIGger:A:TIMeout:TIME	316

TRIGger:A:TIMeout:RANGe <Range>

Sets the relation of the signal level to the threshold.

Parameters:

<Range> HIGH | LOW | EITHer

HIGH

The signal level stays above the trigger level.

LOW

The signal level stays below the trigger level.

EITHer

The signal level stays above or below the trigger level.

*RST: HIGH

TRIGger:A:TIMeout:TIME <Time>

Sets the time limit for the timeout at which the instrument triggers.

Parameters:

<Time> Range: 6.4e-9 to 13.7439
 *RST: 10e-6

15.5.7 Serial Bus

Triggering on the decoded data of a protocol bus is available if at least one serial protocol option is installed. The serial bus must be configured correctly. For detailed infor-

mation on serial protocols and their trigger conditions, see the chapter of the relevant protocol.

15.6 Waveform Analysis

- [Zoom](#).....317
- [Mathematics](#).....318
- [Reference Waveforms](#).....320
- [Search](#).....324
- [History \(Option R&S RTB-K15\)](#).....338

15.6.1 Zoom

TIMEbase:ZOOM:STATE	317
TIMEbase:ZOOM:SCALE	317
TIMEbase:ZOOM:TIME	317
TIMEbase:ZOOM:POSition	318
DISPly:CBAR:ZOOM[:POSition]	318

TIMEbase:ZOOM:STATE <ZoomState>

Switches the zoom on or off.

Parameters:

<ZoomState>	ON OFF
*RST:	OFF

TIMEbase:ZOOM:SCALE <ZoomScale>

Defines the horizontal scale for the zoom window in seconds per division, the timebase of the zoom window. The scaling determines the width of the zoom area (12 divisions * scaling per division).

Parameters:

<ZoomScale>	Range:	Depends on various settings
*RST:		50e-6
	Default unit:	s/div

TIMEbase:ZOOM:TIME <Time>

Defines the distance of the trigger point to the reference point in the zoom window. The value determines the position of the zoom area that is displayed in the zoom window.

Parameters:

<Time>	*RST:	0
	Default unit:	s

TIMEbase:ZOOM:POSition <Position>

Defines the position of the zoom window in the upper window.

Parameters:

<Position>	Range:	Depends on the zoom time base, from nearly 0 to 100 % for large zoom.
	*RST:	50
	Default unit:	%

DISPlay:CBAR:ZOOM[:POSition] <DividerPosition>

Defines the position of the divide bar between normal waveform and zoom window.

Parameters:

<DividerPosition>	Vertical position in pixel, measured from the top edge. The vertical display size is 800 px.
	Default unit: px

15.6.2 Mathematics

To get the data of a math waveform, use the following commands:

- [CALCulate:MATH<m>:DATA?](#) on page 406
- [CALCulate:MATH<m>:DATA:HEADer?](#) on page 406
- [CALCulate:MATH<m>:DATA:POINTs?](#) on page 406
- [CALCulate:MATH<m>:DATA:XORigin?](#) on page 409
- [CALCulate:MATH<m>:DATA:XINCrement?](#) on page 410
- [CALCulate:MATH<m>:DATA:YORigin?](#) on page 410
- [CALCulate:MATH<m>:DATA:YINCrement?](#) on page 411
- [CALCulate:MATH<m>:DATA:YRESolution?](#) on page 411

CALCulate:MATH<m>:STATe	318
CALCulate:MATH<m>[:EXPRession][:DEFine]	319
CALCulate:MATH<m>:LABel	319
CALCulate:MATH<m>:LABel:STATe	320
CALCulate:MATH<m>:POSition	320
CALCulate:MATH<m>:SCALE	320

CALCulate:MATH<m>:STATe <State>

Activates the mathematics function and displays the defined math waveforms.

Suffix:

<m>	1..5
	Selects the math waveform.

Parameters:

<State> ON | OFF
 *RST: OFF

CALCulate:MATH<m>[:EXPRession][:DEFine] <RemComplExpr>

Defines the equation to be calculated for the selected math waveform as a regular expression.

Suffix:

<m> 1..5
 Selects the math waveform.

Parameters:

<RemComplExpr> String parameter, consisting of the mathematical operation and the source(s), written in parenthesis. Optionally, the unit can be included in the string. If no unit is given, the last setting is used.

Example:

CALC:MATH<2>:EXPR:DEF "ADD(CH1,CH2) "

Same command with unit:

CALC:MATH<2>:EXPR:DEF "ADD(CH1,CH2) in V"

Delete the unit:

CALC:MATH<2>:EXPR:DEF "ADD(CH1,CH2) in"

Operation	Expression string	Comment
Addition	"ADD(CH1,CH2) in V"	"CH1+CH2" is also possible
Subtraction	"SUB(CH1,CH2) in V"	"CH1-CH2" is also possible
Multiplication	"MUL(CH1,CH2)"	"CH1*CH2" is also possible
Division	"DIV(CH1,CH2)"	"CH1/CH2" is also possible
Square	"SQR(CH1)"	
Square Root	"SQRT(CH1)"	
Absolute value	"ABS(CH1)"	
Reciprocal	"REC(CH1)"	
Inverse	"INV(CH1)"	
Common logarithm (basis 10)	"LOG(CH1)"	
Natural logarithm (basis e)	"LN(CH1)"	
Derivative	"DERI(CH1)"	
Integral	"INT(CH1)"	
FFT	"FFTMAG(CH1)"	FFT function of the source waveform

CALCulate:MATH<m>:LABel <Label>

Defines a label for the specified math waveform (equation), which is shown at the waveform.

Suffix:

<m> 1..5
Selects the math waveform.

Parameters:

<Label> String Data
String with label text

CALCulate:MATH<m>:LABel:STATe <LabelVisible>

Activates the display of the label that is defined with `CALCulate:MATH<m>:LABel`.

Suffix:

<m> 1..5
Selects the math waveform.

Parameters:

<LabelVisible> ON | OFF

CALCulate:MATH<m>:POSition <Position>

Sets the vertical position of the math waveform.

Suffix:

<m> 1..5
Selects the math waveform.

Parameters:

<Position> Position value, given in divisions.

CALCulate:MATH<m>:SCALE <Scale>

Sets the vertical scale of the math waveform.

Suffix:

<m> 1..5
Selects the math waveform.

Parameters:

<Scale> Scale value, given in Volts per division

15.6.3 Reference Waveforms

In all `REFCurve:...` commands, the suffix <m> selects the reference waveform.

To get the waveform data, use the following commands:

- `REFCurve<m>:DATA?` on page 407
- `REFCurve<m>:DATA:HEADer?` on page 407
- `REFCurve<m>:DATA:XINCrement?` on page 410
- `REFCurve<m>:DATA:XORigin?` on page 409

- [REFCurve<m>:DATA:YINCrement?](#) on page 411
- [REFCurve<m>:DATA:YORigin?](#) on page 410
- [REFCurve<m>:DATA:YRESolution?](#) on page 411

REFCurve<m>:SOURce	321
REFCurve<m>:SOURce:CATalog?	321
REFCurve<m>:STATe	322
REFCurve<m>:UPDate	322
REFCurve<m>:SAVE	322
REFCurve<m>:LOAD	322
REFCurve<m>:LOAD:STATe	323
REFCurve<m>:HORizontal:POSition	323
REFCurve<m>:HORizontal:SCALe	323
REFCurve<m>:VERTical:POSition	323
REFCurve<m>:VERTical:SCALe	324
REFCurve<m>:WCOLor	324
REFCurve<m>:LABel	324

REFCurve<m>:SOURce <Source>

Defines the source of the reference waveform.

Suffix:

<m> 1..4
Selects the reference waveform

Parameters:

<Source> CH1 | CH2 | CH3 | CH4 | MA1 | MA2 | MA3 | MA4 | MA5 | RE1 | RE2 | RE3 | RE4 | D70 | D158 | SPEC | MINH | MAXH | AVER

CH1 | CH2 | CH3 | CH4 | MA1 | MA2 | MA3 | MA4 | MA5 | RE1 | RE2 | RE3 | RE4
Any active channel, math, or reference waveform. CH3 and CH4 are only available with 4-channel R&S RTB2000 oscilloscopes.

D70 | D158
Logic probes, sources require MSO option R&S RTB-B1.

SPEC | MINH | MAXH | AVER
FFT waveforms: spectrum, min hold, max hold, average.

*RST: CH1

REFCurve<m>:SOURce:CATalog?

Returns the source waveform.

Suffix:

<m> 1..4
Selects the reference waveform.

Parameters:

<Source Catalogue> CH1 | CH2 | CH3 | CH4 | QMA | RE1 | RE2 | RE3 | RE4 | D70 | D158 | SPEC | MINH | MAXH | AVER

See [REFCurve<m>:SOURCE](#) on page 321.

Usage: Query only

REFCurve<m>:STATE

Displays or hides the selected reference waveform.

Suffix:

<m> 1..4
Selects the reference waveform.

Parameters:

<State> ON | OFF
*RST: OFF

REFCurve<m>:UPDATE

Updates the selected reference by the waveform defined with [REFCurve<m>:SOURCE](#).

Suffix:

<m> 1..4
Selects the reference waveform.

Usage: Event

REFCurve<m>:SAVE <Filename>

Stores the reference waveform in the specified file.

Suffix:

<m> 1..4
Selects the reference waveform.

Setting parameters:

<Filename> String with path and file name

Usage: Setting only

REFCurve<m>:LOAD <Filename>

Loads the waveform data from the indicated reference file to the reference waveform.

To load the correspondent instrument settings, use [REFCurve<m>:LOAD:STATE](#) on page 323.

Suffix:

<m> 1..4
Selects the reference waveform.

Setting parameters:

<Filename> String with path and file name

Usage: Setting only

REFCurve<m>:LOAD:STATE

Loads the instrument settings in addition to the reference waveform data. The waveform data must be loaded before the settings, see [REFCurve<m>:LOAD](#) on page 322.

The settings are only available if the file was stored to the internal storage and never written to a USB flash device.

Suffix:

<m> 1..4
Selects the reference waveform.

Usage: Event

REFCurve<m>:HORizontal:POSition <Position>

Changes the horizontal position of the reference waveform independently of the channel waveform settings.

Suffix:

<m> 1..4
Selects the reference waveform.

Parameters:

<Position> Default unit: s

REFCurve<m>:HORizontal:SCALE <Scale>

Changes the horizontal scale (timebase) of the reference waveform independently of the channel waveform settings.

Suffix:

<m> 1..4
Selects the reference waveform.

Parameters:

<Scale> Default unit: s/div

REFCurve<m>:VERTical:POSition <Position>

Changes the vertical position of the reference waveform.

Suffix:

<m> 1..4
Selects the reference waveform.

Parameters:

<Position> Default unit: div

REFCurve<m>:VERTical:SCALE <Scale>

Changes the vertical scale of the reference waveform.

Suffix:

<m> 1..4
Selects the reference waveform.

Parameters:

<Scale> Default unit: V/div

REFCurve<m>:WCOLor <WaveformColor>

Selects a color for the reference waveform. The default color is white. You can select another monochrome color, or a color scale.

Suffix:

<m> 1..4
Selects the reference waveform.

Parameters:

<WaveformColor> YELLOW | GREEN | ORANGE | BLUE | LBLUE | WHITE | CYAN |
PINK | RED | TEMPERATURE | RAINBOW | FIRE | DEFAULT
*RST: DEF

REFCurve<m>:LABEL <WaveformLabel>

Defines a label for the indicated reference waveform.

Suffix:

<m> 1..4
Selects the reference waveform.

Parameters:

<WaveformLabel> String parameter
String parameter

Example:

REFCurve2:LABEL "Origin"
Sets the label "Origin" for reference R2.

15.6.4 Search

- [General Search Settings](#)..... 325
- [Edge Search Configuration](#)..... 326
- [Width Search Configuration](#)..... 327
- [Peak Search Configuration](#)..... 328
- [Rise/Fall Time Search Configuration](#)..... 329
- [Runt Search Configuration](#)..... 331
- [Data2Clock Search Configuration](#)..... 332
- [Pattern Search Configuration](#)..... 334
- [Search Results](#)..... 336

15.6.4.1 General Search Settings

SEARch:STATe.....	325
SEARch:CONDition.....	325
SEARch:SOURce.....	326

SEARch:STATe <SearchState>

Enables and disables the search mode.

Parameters:

<SearchState> ON | OFF
 *RST: OFF

Example: [Chapter 15.2.3.1, "Searching for a Pulse of Specified Width", on page 285](#)

SEARch:CONDition <SearchCondition>

Parameters:

<SearchCondition> EDGE | WIDTH | PEAK | RUNT | RTIME | DATatoclock |
 PATTErn | PROTOcol

EDGE

An edge search result is found when the waveform passes the given level in the specified direction.

WIDTH

A width search finds pulses with an exact pulse width, or pulses shorter or longer than a given time, or pulses inside or outside the allowable time range.

PEAK

The peak search finds pulses exceeding a given amplitude.

RUNT

The runt search finds pulses lower than normal in amplitude. The amplitude crosses the first threshold twice without crossing the second one. In addition to the threshold amplitudes, you can define a time limit for the runt in the same way as for width search: runts with exact width, shorter or longer than a given time, or runts inside or outside the allowable time range.

RTIME

The rise or fall time search finds slopes with an exact rise or fall time, or rise/fall times shorter or longer than a given limit, or rise/fall times inside or outside the allowable time range.

DATatoclock

The Data2Clock search - also known as setup/hold - finds violation of setup and hold times. It analyzes the relative timing between two signals: a data signal and the synchronous clock signal. Setup time is the time that the data signal is steady before clock edge. Hold time is the time that the data signal is steady after clock edge.

PATtern

The pattern search finds logical combinations of channel states inside or outside a specified time range. For each channel, its state and threshold level is defined. The states are combined logically, and the time of true pattern results is compared with a specified time range.

PROTOCOL

The protocol search finds various events in decoded data of signals, for example, a specified frame type, identifier, data, and errors. Available search settings depend on the configured bus type.

Protocol search is not available for bus types PARallel, I2C, SPI (no CS), SPI (with CS), and UART.

*RST: EDGE

SEARCh:SOURce <SearchSource>

Selects the waveform to be analyzed.

Parameters:

<SearchSource> CH1 | CH2 | CH3 | CH4 | QMA | RE1 | RE2 | RE3 | RE4

Any active channel, math, or reference waveform can be searched.

For protocol search on CAN and LIN signals, an active serial bus is the search source.

*RST: CH1

Example: [Chapter 15.2.3.1, "Searching for a Pulse of Specified Width", on page 285](#)

15.6.4.2 Edge Search Configuration

SEARCh:TRIGger:EDGE:SLOPe.....	326
SEARCh:TRIGger:EDGE:LEVel.....	326
SEARCh:TRIGger:EDGE:LEVel:DELTA.....	327

SEARCh:TRIGger:EDGE:SLOPe <Slope>

Sets the slope to be searched for.

Parameters:

<Slope> POSitive | NEGative | EITHER

*RST: POS

SEARCh:TRIGger:EDGE:LEVel <Level>

Sets the voltage level for the edge search.

Parameters:

<Level> *RST: 0.5 V

SEARch:TRIGger:EDGE:LEVel:DELTA <DeltaLevel>

Sets a hysteresis range above and below the search level to avoid unwanted search results caused by noise oscillation around the level.

Parameters:

<DeltaLevel> Range: Lower limit depends on vertical scale and other settings, no upper limit
 *RST: 0.2 V

15.6.4.3 Width Search Configuration

SEARch:TRIGger:WIDTh:POLarity.....	327
SEARch:TRIGger:WIDTh:LEVel.....	327
SEARch:TRIGger:WIDTh:LEVel:DELTA.....	327
SEARch:TRIGger:WIDTh:RANGe.....	328
SEARch:TRIGger:WIDTh:WIDTh.....	328
SEARch:TRIGger:WIDTh:DELTA.....	328

SEARch:TRIGger:WIDTh:POLarity <Polarity>

Indicates the polarity of the pulse to be searched for.

Parameters:

<Polarity> POSitive | NEGative
 *RST: POS

Example: [Chapter 15.2.3.1, "Searching for a Pulse of Specified Width", on page 285](#)

SEARch:TRIGger:WIDTh:LEVel <Level>

Sets the voltage level on which the pulse width is measured.

Parameters:

<Level> *RST: 500 mV

SEARch:TRIGger:WIDTh:LEVel:DELTA <DeltaLevel>

Sets a hysteresis range above and below the search level to avoid unwanted search results caused by noise oscillation around the level.

Parameters:

<DeltaLevel> Range: Lower limit depends on vertical scale and other settings, no upper limit
 *RST: 200 mV

SEARch:TRIGger:WIDTh:RANGe <Range>

Sets how the measured pulse width is compared with the given limit(s).

To set the width, use `SEARch:TRIGger:WIDTh:WIDTh`.

To set the range $\pm \Delta t$, use `SEARch:TRIGger:WIDTh:DELTA`.

Parameters:

<Range> WITHin | OUTSide | SHORter | LONGer

WITHin

Finds pulses inside the range $width \pm \Delta t$.

OUTSide

Finds pulses outside the range $width \pm \Delta t$.

SHORter

Finds pulses shorter than the given width.

LONGer

Finds pulses longer than the given width.

*RST: WITH

Example: [Chapter 15.2.3.1, "Searching for a Pulse of Specified Width"](#), on page 285

SEARch:TRIGger:WIDTh:WIDTh <Width>

Sets the reference pulse width, the nominal value for comparisons.

Parameters:

<Width> Default unit: s

Example: [Chapter 15.2.3.1, "Searching for a Pulse of Specified Width"](#), on page 285

SEARch:TRIGger:WIDTh:DELTA <DeltaWidth>

Sets a range Δt to the reference pulse width set with `SEARch:TRIGger:WIDTh:WIDTh`, if `SEARch:TRIGger:WIDTh:RANGe` is set to `WITHin` or `OUTSide`.

Parameters:

<DeltaWidth> Range: Lower limit depends on the resolution, practically no upper limit

Example: [Chapter 15.2.3.1, "Searching for a Pulse of Specified Width"](#), on page 285

15.6.4.4 Peak Search Configuration

`SEARch:MEASure:PEAK:POLarity`..... 329
`SEARch:MEASure:LEVel:PEAK:MAGNitude`..... 329

SEARCh:MEASure:PEAK:POLarity <Polarity>

Indicates the polarity of a the pulse to be searched for a peak.

Parameters:

<Polarity> POSitive | NEGative | EITHer
*RST: POS

SEARCh:MEASure:LEVel:PEAK:MAGNitude <Magnitude>

Sets the peak-to-peak limit. If the signal exceeds this limit, a search event is listed.

Parameters:

<Magnitude> Default unit: V

15.6.4.5 Rise/Fall Time Search Configuration

SEARCh:TRIGger:RISetime:SLOPe.....	329
SEARCh:TRIGger:LEVel:RISetime:LOWer.....	329
SEARCh:TRIGger:LEVel:RISetime:UPPer.....	329
SEARCh:TRIGger:RISetime:RANGe.....	330
SEARCh:TRIGger:RISetime:TIME.....	330
SEARCh:TRIGger:RISetime:DELTA.....	330

SEARCh:TRIGger:RISetime:SLOPe <Polarity>

Sets the slope to be found.

Parameters:

<Polarity> POSitive | NEGative | EITHer
 POSitive: to search for rise time.
 NEGative: to search for fall time.
 EITHer: to search for rise and fall time.
*RST: POS

SEARCh:TRIGger:LEVel:RISetime:LOWer <LowerLevel>

Sets the lower voltage threshold. When the signal crosses this level, the rise time measurement starts or stops depending on the selected slope.

Parameters:

<LowerLevel> *RST: 400 mV
 Default unit: V

SEARCh:TRIGger:LEVel:RISetime:UPPer <UpperLevel>

Sets the upper voltage threshold. When the signal crosses this level, the rise/fall time measurement starts or stops depending on the selected slope.

Parameters:

<UpperLevel> *RST: 600 mV
 Default unit: V

SEARCH:TRIGger:RISetime:RANGE <Range>

Sets how the measured rise or fall time is compared with the given limit(s).

To set the rise/fall time, use `SEARCH:TRIGger:RISetime:TIME`.

To set the range $\pm \Delta t$, use `SEARCH:TRIGger:RISetime:DELTA`.

Parameters:

<Range> LONGer | SHORter | WITHin | OUTSide

LONGer

Finds rise/fall times longer than the given time.

SHORter

Finds rise/fall times shorter than the given time.

WITHin

Finds rise/fall times inside the range *time* $\pm \Delta t$.

OUTSide

Finds rise/fall times outside the range *time* $\pm \Delta t$.

*RST: LONG

SEARCH:TRIGger:RISetime:TIME <Time>

Sets the reference rise or fall time, the nominal value for comparisons.

Parameters:

<Time> Range: Depends on various settings, mainly time base and sample rate
 *RST: 200e-6
 Default unit: s

SEARCH:TRIGger:RISetime:DELTA <DeltaTime>

Sets a range Δt to the reference rise/fall time set with `SEARCH:TRIGger:RISetime:TIME`, if `SEARCH:TRIGger:RISetime:RANGE` is set to `Within` or `Outside`. The instrument finds rise/fall times inside or outside the range *time* $\pm \Delta t$.

Parameters:

<DeltaTime> Range: Depends on various settings, mainly time base and sample rate
 *RST: 50e-6
 Default unit: s

15.6.4.6 Runt Search Configuration

SEARch:TRIGger:RUNT:POLarity.....	331
SEARch:TRIGger:LEVel:RUNT:LOWer.....	331
SEARch:TRIGger:LEVel:RUNT:UPPer.....	331
SEARch:TRIGger:RUNT:RANGe.....	331
SEARch:TRIGger:RUNT:WIDTh.....	332
SEARch:TRIGger:RUNT:DELTA.....	332

SEARch:TRIGger:RUNT:POLarity <Polarity>

Indicates the polarity of a the runt to be searched for.

Parameters:

<Polarity> POSitive | NEGative | EITHER
 *RST: POS

SEARch:TRIGger:LEVel:RUNT:LOWer <LowerLevel>

Sets the lower voltage threshold for runt detection. A positive runt crosses the lower level twice without crossing the upper level.

Parameters:

<LowerLevel> Range: Depends on vertical scale and LSB value.
 *RST: 400 mV
 Default unit: V

SEARch:TRIGger:LEVel:RUNT:UPPer <UpperLevel>

Sets the upper voltage threshold for runt detection. A negative runt crosses the upper level twice without crossing the lower level.

Parameters:

<UpperLevel> Range: Depends on vertical scale and LSB value.
 *RST: 600 mV
 Default unit: V

SEARch:TRIGger:RUNT:RANGe <Range>

Sets how the measured pulse width is compared with the given limit(s).

To set the width, use `SEARch:TRIGger:RUNT:WIDTh`.

To set the range $\pm \Delta t$, use `SEARch:TRIGger:RUNT:DELTA`.

Parameters:

<Range> LONGer | SHORter | WITHin | OUTSide
LONGer
 Finds pulses longer than the given width.
SHORter
 Finds pulses shorter than the given width.

WITHin

Finds pulses inside the range $width \pm \Delta t$.

OUTSide

Finds pulses outside the range $width \pm \Delta t$.

*RST: LONG

SEARch:TRIGger:RUNT:WIDTh <Width>

Sets the reference runt pulse width, the nominal value for comparisons.

Parameters:

<Width> Range: Depends on various settings, mainly time base and sample rate.
 *RST: 200e-6
 Default unit: s

SEARch:TRIGger:RUNT:DELTA <DeltaWidth>

Sets a range Δt to the reference pulse width set with `SEARch:TRIGger:RUNT:WIDTh`, if `SEARch:TRIGger:RUNT:RANGe` is set to `WITHin` or `OUTSide`.

Parameters:

<DeltaWidth> Range: Depends on various settings, mainly time base and sample rate.
 *RST: 50e-6
 Default unit: s

15.6.4.7 Data2Clock Search Configuration

<code>SEARch:TRIGger:DATatoclock:CSORce</code>	332
<code>SEARch:TRIGger:DATatoclock:CLEVel</code>	333
<code>SEARch:TRIGger:DATatoclock:DLEVel</code>	333
<code>SEARch:TRIGger:DATatoclock:CLEVel:DELTA</code>	333
<code>SEARch:TRIGger:DATatoclock:DLEVel:DELTA</code>	333
<code>SEARch:TRIGger:DATatoclock:CEdGe</code>	333
<code>SEARch:TRIGger:DATatoclock:HTIME</code>	333
<code>SEARch:TRIGger:DATatoclock:STIME</code>	333

SEARch:TRIGger:DATatoclock:CSORce <ClockSource>

Selects the input channel of the clock signal.

Parameters:

<ClockSource> CH1 | CH2 | CH3 | CH4
 *RST: CH1

SEARCh:TRIGger:DATatoclock:CLEVel <ClockLevel>

Sets the voltage level for the clock signal. The crossing of clock level and clock edge defines the start point for setup and hold time.

Parameters:

<ClockLevel> Range: Depends on vertical scale

SEARCh:TRIGger:DATatoclock:DLEVel <DataLevel>

Sets the voltage level for the data signal. The data level defines the threshold for data transition.

Parameters:

<DataLevel> Range: Depends on vertical scale

SEARCh:TRIGger:DATatoclock:CLEVel:DELTA <LevelDelta>**SEARCh:TRIGger:DATatoclock:DLEVel:DELTA** <LevelDelta>

Set a hysteresis range to the clock and data levels in order to avoid unwanted search results caused by noise oscillation around the level.

Parameters:

<LevelDelta> Range: Lower limit depends on vertical scale and other settings, no upper limit

SEARCh:TRIGger:DATatoclock:CEdGe <ClockEdge>

Sets the edge of the clock signal to define the start point for the setup and hold time.

Parameters:

<ClockEdge> POSitive | NEGative | EITHER
*RST: POS

SEARCh:TRIGger:DATatoclock:HTIME <HoldTime>

Sets the minimum time **after** the clock edge while the data signal must stay steady above or below the data level. The hold time can be negative. In this case, the hold time ends before the clock edge, and the setup time must be positive and longer than the absolute value of the hold time.

Parameters:

<HoldTime> Range: Depends on time base and sample interval

SEARCh:TRIGger:DATatoclock:STIME <SetupTime>

Sets the minimum time **before** the clock edge while the data signal must stay steady above or below the data level. The setup time can be negative. In this case, the setup interval starts after the clock edge, and the hold time must be positive and longer than the absolute value of the setup time.

Parameters:

<SetupTime> Range: Depends on time base and sample interval

15.6.4.8 Pattern Search Configuration

SEARch:TRIGger:PATtern:SOURce.....	334
SEARch:TRIGger:PATtern:FUNction.....	334
SEARch:TRIGger:PATtern:LEVel<n>.....	335
SEARch:TRIGger:PATtern:LEVel<n>:DELTA.....	335
SEARch:TRIGger:PATtern:WIDTh:RANGe.....	335
SEARch:TRIGger:PATtern:WIDTh[:WIDTh].....	336
SEARch:TRIGger:PATtern:WIDTh:DELTA.....	336

SEARch:TRIGger:PATtern:SOURce <Pattern>

Specifies the search pattern - the state for each channel. The state can be set only for active channels.

Parameters:

<Pattern> String parameter
 String containing 0, 1, X|x for each channel. The order of channels is fixed: CH1 CH2 [CH3 CH4] D0 D1 D2 D3 ...

Example:

```

CHAN1:STAT ON
CHAN2:STAT ON
CHAN3:STAT ON
CHAN4:STAT ON
SEAR:STAT ON
SEAR:COND PATT
SEAR:TRIG:PATT:SOUR '1X10'
```

CH1, CH3 are high, CH4 is low. These states are logically combined with `SEARch:TRIGger:PATtern:FUNction`. CH2 does not matter (don't care) and can be off.

SEARch:TRIGger:PATtern:FUNction <Function>

Sets the logical combination of the channel states.

Parameters:

<Function> AND | OR | NAND | NOR

AND

The required states of all channels must appear in the input signal at the same time.

OR

At least one of the channels must have the required state.

NAND

"Not and" operator, at least one of the channels does not have the required state.

NOR

"Not or" operator, none of the channels has the required state.

*RST: AND

SEARCh:TRIGger:PATtern:LEVel<n> <ThresholdLevel>

Sets the threshold value for the specified source channel. You can set different levels for the channels

Suffix:

<n> 1..4
Selects the input channel. The number of channels depends on the instrument.

Parameters:

<ThresholdLevel> Range: Depends on vertical scale

SEARCh:TRIGger:PATtern:LEVel<n>:DELTA <LevelDelta>

Sets a hysteresis range to the threshold of the specified source channel to avoid unwanted search results caused by noise oscillation around the level.

Suffix:

<n> 1..4
Selects the input channel. The number of channels depends on the instrument.

Parameters:

<LevelDelta> Range: Lower limit depends on vertical scale and other settings, no upper limit

SEARCh:TRIGger:PATtern:WIDTh:RANGe <Range>

Sets the condition how the duration of a steady pattern is compared with the given reference time.

To set the reference value *width*, use `SEARCh:TRIGger:PATtern:WIDTh[:WIDTh]`.

To set a range Δt , use `SEARCh:TRIGger:PATtern:WIDTh:DELTA`

Parameters:

<Range> WITHin | OUTSide | LONGer | SHORter
WITHin
Finds patterns steady for a time range $width \pm \Delta t$.
OUTSide
Finds patterns outside a time range $width \pm \Delta t$.
LONGer
Finds patterns steady for at least the given *width*.
SHORter
Finds patterns shorter than the given *width*.

*RST: LONG

SEARCh:TRIGger:PATtern:WIDTh[:WIDTh] <Width>

Sets the reference time of a steady pattern, the nominal value for comparisons.

Parameters:

<Width> Default unit: s

SEARCh:TRIGger:PATtern:WIDTh:DELTA <DeltaTime>

Sets a range Δt to the reference pattern duration set with [SEARCh:TRIGger:PATtern:WIDTh\[:WIDTh\]](#), if [SEARCh:TRIGger:PATtern:WIDTh:RANGe](#) is set to [WITHin](#) or [OUTSide](#).

Parameters:

<DeltaTime> Default unit: s

15.6.4.9 Search Results

SEARCh:RESult:BCOunt?	336
SEARCh:RESDiagram:SHOW	336
SEARCh:RESult:ALL?	337
SEARCh:RESult<n>?	337
SEARCh:RCOunt?	338
EXPort:SEARCh:NAME	338
EXPort:SEARCh:SAVE	338

SEARCh:RESult:BCOunt?

Returns the maximum number of search results, which the instrument can store.

Return values:

<BufferedCount> Maximum number of search results

Usage: Query only

SEARCh:RESDiagram:SHOW <ResultShow>

Shows or hides the table of search results.

Parameters:

<ResultShow> ON | OFF

*RST: OFF

Example: [Chapter 15.2.3.1, "Searching for a Pulse of Specified Width"](#), on page 285

SEARCh:RESult:ALL?

Returns all result values of the search.

Return values:

<AllResults> List of results items separated by comma
 For each result, six values are returned:
 1. Result number as indicated in the search results table
 2. X-position (time) of the search result
 3. Y-position of the search result, currently not relevant
 4. Type of the search result (Edge, Peak, ...)
 5. Slope or polarity of the search result
 6. For peak searches, the value contains the peak voltage. For width searches, it contains the pulse width. For edge searches, the value is not relevant.

Example:

SEARCh:RESult:ALL?

Returns all four results of a peak search:

```
1, -4.7750e-04, 0, PEAK, NEGATIVE, -1.530e-02, 2,
-4.4630e-04, 0, PEAK, NEGATIVE, -1.530e-02, 3,
-4.1660e-04, 0, PEAK, NEGATIVE, -1.530e-02, 4,
-3.8690e-04, 0, PEAK, NEGATIVE, -1.530e-02
```

Example:

[Chapter 15.2.3.1, "Searching for a Pulse of Specified Width"](#), on page 285

Usage:

Query only

SEARCh:RESult<n>?

Returns the result values of the specified search result.

See also: [SEARCh:RESult:ALL?](#)

Suffix:

<n> *
 Number of the search result

Return values:

<Result> Comma-separated value list
 Meaning of the values:
 Result number, time value, y-position (not relevant), search type, slope or polarity, optional value: voltage for peak search, pulse width for width search.

Example:

SEARCh:RESult3?

Returns the result values of the third search result.

```
3, -4.1660e-04, 0, PEAK, NEGATIVE, -1.530e-02
```

Usage:

Query only

SEARch:RCOut?

Returns the number of search results.

Return values:

<ResultCount> *RST: 0

Example: [Chapter 15.2.3.1, "Searching for a Pulse of Specified Width", on page 285](#)

Usage: Query only

EXPort:SEARch:NAME <FileName>

Defines the path and filename for search results that will be saved with [EXPort:SEARch:SAVE](#). The file format is CSV, the filename is incremented automatically.

You can change the file name manually in the [Search] > "Save" dialog. Remote control uses the recent settings.

Parameters:

<FileName> String parameter

Example: `EXPort:SEARch:NAME "/USB_FRONT/SEARCH/RESULT"`
On first save, the search results are saved to RESULT.CSV, on second save to RESULT01.CSV, the third to RESULT02.CSV ...

EXPort:SEARch:SAVE

Saves the search results to the path and file defined by [EXPort:SEARch:NAME](#).

Usage: Setting only

15.6.5 History (Option R&S RTB-K15)

- [History Settings](#)..... 338
- [Displaying History Segments](#)..... 341
- [Timestamps](#).....344
- [Export of History Data](#)..... 348

15.6.5.1 History Settings

ACQuire:MEMory[:MODE] <MemoryMode>

Defines how the record length is set.

Parameters:

<MemoryMode> AUTomatic | DMEMory | MANual
AUTomatic
Automatically by the instrument

DMEMory

Predefined values are set with `ACQUIRE:POINTS[:VALUE]`

MANual

User-defined value is set with `ACQUIRE:POINTS[:VALUE]`.

The number of available history segments is adjusted automatically.

*RST: AUT

ACQUIRE:POINTS:AUTomatic <AutoRecordLength>

Enables or disables the automatic record length. The instrument sets a value that fits to the selected timebase.

If you set a specific value with `ACQUIRE:POINTS[:VALUE]`, the automatic assignment of a record length is turned off.

Parameters:

<AutoRecordLength> ON | OFF

Example:

```
ACQ:POIN:AUT ON
TIM:SCAL 1e-9
ACQ:POIN?;:SYST:ERR:ALL?
-> received 10000;0,"No error"
TIM:SCAL 5e-3
ACQ:POIN?;:SYST:ERR:ALL?
-> received 20000000;0,"No error"
```

ACQUIRE:POINTS[:VALUE]

Defines a record length value, the number of recorded waveform points in a segment.

The command turns `ACQUIRE:POINTS:AUTomatic` OFF.

If `ACQUIRE:POINTS:AUTomatic` is turned ON, the query `ACQUIRE:POINTS?` returns the automatically set record length.

Each predefined record length corresponds to a maximum number of history segments, which are stored in the instrument's memory. If option R&S RTB-K15 is installed, you can display the history segments.

Available record length values are:

- 10 kSa (13107 history segments)
- 20 kSa (13107 history segments)
- 50 kSa (3276 history segments)
- 100 kSa (2621 history segments)
- 200 kSa (1456 history segments)
- 500 kSa (319 history segments)
- 1 MSa (319 history segments)
- 2 MSa (159 history segments)

- 5 MSa (40 history segments)
- 10 MSa (32 history segments)
- 20 MSa (16 history segments)

Parameters:

<RecordLength> Record length in Samples.
If the entered value differs from the predefined values, the instrument sets the closest value.

ACQUIRE:NSINGLE:COUNT <NSingleCount>

Sets the number of waveforms acquired with [RUNSingle](#).

Parameters:

<NSingleCount> Number of waveforms.
Range: 1 to maximum number that depends on the record length.
*RST: 1

ACQUIRE:AVAILABLE?

Returns the number of segments that are currently saved in the memory. This number is available for history viewing.

Parameters:

<Acquisitions> Number of captured segments

Usage: Query only

ACQUIRE:SEGMENTED:STATE <State>

If ON, the acquisitions are performed as fast as possible, without processing and displaying the waveforms. When acquisition has been stopped, the data is processed and the latest waveform is displayed. Older waveforms are stored in segments. You can display and analyze the segments using the history..

Parameters:

<State> ON | OFF

ACQUIRE:AVERAGE:CURRENT?

Returns the current amount of acquired waveforms that contribute to the average. The value is independent of the number of available segments, there are more waveforms in the average available than segments in history.

Parameters:

<CurrentAverages> Range: Minimum is 2; maximum depends on the instrument settings.

Usage: Query only

15.6.5.2 Displaying History Segments

The commands in this chapter use numeric suffixes:

- CHANnel<m>: Selects the analog input channel.
- DIGital<m>: Selects the logic channel, range 0..15
- LOGic<p>: Selects the logic pod, range 1..2
- BUS: Selects the bus, range 1..4

CALCulate:MATH<m>:HISTory:CONTRol:ENABle]	342
BUS:HISTory:CONTRol:ENABle]	342
DIGital<m>:HISTory:CONTRol:ENABle]	342
LOGic<p>:HISTory:CONTRol:ENABle]	342
CHANnel<m>:HISTory:CONTRol:[ENABle]	342
CALCulate:MATH<m>:HISTory:CURRent	342
BUS:HISTory:CURRent	342
DIGital<m>:HISTory:CURRent	342
LOGic<p>:HISTory:CURRent	342
SPECTrum:HISTory:CURRent	342
CHANnel<m>:HISTory:CURRent	342
CALCulate:MATH<m>:HISTory:PALL	342
BUS:HISTory:PALL	342
DIGital<m>:HISTory:PALL	342
LOGic<p>:HISTory:PALL	342
SPECTrum:HISTory:PALL	342
CHANnel<m>:HISTory:PALL	342
CALCulate:MATH<m>:HISTory:STARt	343
BUS:HISTory:STARt	343
DIGital<m>:HISTory:STARt	343
LOGic<p>:HISTory:STARt	343
SPECTrum:HISTory:STARt	343
CHANnel<m>:HISTory:STARt	343
CALCulate:MATH<m>:HISTory:STOP	343
BUS:HISTory:STOP	343
DIGital<m>:HISTory:STOP	343
LOGic<p>:HISTory:STOP	343
SPECTrum:HISTory:STOP	343
CHANnel<m>:HISTory:STOP	343
CALCulate:MATH<m>:HISTory:PLAYer:SPEEd	343
BUS:HISTory:PLAYer:SPEEd	343
DIGital<m>:HISTory:PLAYer:SPEEd	343
LOGic<p>:HISTory:PLAYer:SPEEd	343
SPECTrum:HISTory:PLAYer:SPEEd	343
CHANnel<m>:HISTory:PLAYer:SPEEd	343
CALCulate:MATH<m>:HISTory:REPLay	343
BUS:HISTory:REPLay	343
DIGital<m>:HISTory:REPLay	343
LOGic<p>:HISTory:REPLay	344
SPECTrum:HISTory:REPLay	344
CHANnel<m>:HISTory:REPLay	344

CALCulate:MATH<m>:HISTory:PLAYer:STATe.....	344
BUS:HISTory:PLAYer:STATe.....	344
DIGital<m>:HISTory:PLAYer:STATe.....	344
LOGic<p>:HISTory:PLAYer:STATe.....	344
SPECtrum:HISTory:PLAYer:STATe.....	344
CHANnel<m>:HISTory:PLAYer:STATe.....	344

CALCulate:MATH<m>:HISTory:CONTRol:ENABle] <PlayerControlEnable>
BUS:HISTory:CONTRol:ENABle] <PlayerControlEnable>
DIGital<m>:HISTory:CONTRol:ENABle] <PlayerControlEnable>
LOGic<p>:HISTory:CONTRol:ENABle] <PlayerControlEnable>
CHANnel<m>:HISTory:CONTRol:[ENABle] <PlayerControl>

Displays or hides the history player on the screen.

Parameters:

<PlayerControl> ON | OFF
 *RST: OFF

CALCulate:MATH<m>:HISTory:CURRent <CurrentAcquisition>
BUS:HISTory:CURRent <CurrentAcquisition>
DIGital<m>:HISTory:CURRent <CurrentAcquisition>
LOGic<p>:HISTory:CURRent <CurrentAcquisition>
SPECtrum:HISTory:CURRent <CurrentAcquisition>
CHANnel<m>:HISTory:CURRent <CurrentAcquisition>

Accesses a particular history segment in the memory to display it. The query returns the index of the segment that is shown.

Parameters:

<CurrentAcquisition> Segment index. There are two ways to enter the index.
 Negative index count: the newest segment has the index "0",
 older segments have a negative index: -(n-1), -1 , 0
 Positive index count: the oldest segment has the index 1, and
 the newest segment has the index n: 1, 2,..., n
 where n is the number of acquired segments.

CALCulate:MATH<m>:HISTory:PALL <PlayAll>
BUS:HISTory:PALL <PlayAll>
DIGital<m>:HISTory:PALL <PlayAll>
LOGic<p>:HISTory:PALL <PlayAll>
SPECtrum:HISTory:PALL <PlayAll>
CHANnel<m>:HISTory:PALL <PlayAll>

Enables the replay of all acquired segments.

Parameters:

<PlayAll> ON | OFF

If set to OFF, define the range of segments to be shown using
[CHANnel<m>:HISTory:START](#) and [CHANnel<m>:HISTory:STOP](#)

*RST: ON

CALCulate:MATH<m>:HISTory:START <StartAcquisition>**BUS:HISTory:START** <StartAcquisition>**DIGital<m>:HISTory:START** <StartAcquisition>**LOGic<p>:HISTory:START** <StartAcquisition>**SPECtrum:HISTory:START** <StartAcquisition>**CHANnel<m>:HISTory:START** <StartAcquisition>

Sets the index of the oldest segment to be displayed.

Parameters:

<StartAcquisition> Start index. You can enter a positive or negative index, see
[CHANnel<m>:HISTory:CURRent](#) .

CALCulate:MATH<m>:HISTory:STOP <StopAcquisition>**BUS:HISTory:STOP** <StopAcquisition>**DIGital<m>:HISTory:STOP** <StopAcquisition>**LOGic<p>:HISTory:STOP** <StopAcquisition>**SPECtrum:HISTory:STOP** <StopAcquisition>**CHANnel<m>:HISTory:STOP** <StopAcquisition>

Sets the index of the latest segment to be displayed.

Parameters:

<StopAcquisition> Stop index. You can enter a positive or negative index, see
[CHANnel<m>:HISTory:CURRent](#).

CALCulate:MATH<m>:HISTory:PLAYer:SPEEd <PlayerSpeed>**BUS:HISTory:PLAYer:SPEEd** <PlayerSpeed>**DIGital<m>:HISTory:PLAYer:SPEEd** <PlayerSpeed>**LOGic<p>:HISTory:PLAYer:SPEEd** <PlayerSpeed>**SPECtrum:HISTory:PLAYer:SPEEd** <PlayerSpeed>**CHANnel<m>:HISTory:PLAYer:SPEEd** <PlayerSpeed>

Sets the speed of the history replay.

Parameters:

<PlayerSpeed> SLOW | MEDium | FAST | AUTO

*RST: AUTO

CALCulate:MATH<m>:HISTory:REPLay <Replay>**BUS:HISTory:REPLay** <Replay>**DIGital<m>:HISTory:REPLay** <Replay>

LOGic<p>:HISTory:REPLay <Replay>
SPECTrum:HISTory:REPLay <Replay>
CHANnel<m>:HISTory:REPLay <Replay>

If set to ON, the replay of the selected history segments repeats automatically.

Parameters:

<Replay> ON | OFF
 *RST: STOP

CALCulate:MATH<m>:HISTory:PLAYer:STATe <PlayerState>
BUS:HISTory:PLAYer:STATe <PlayerState>
DIGital<m>:HISTory:PLAYer:STATe <PlayerState>
LOGic<p>:HISTory:PLAYer:STATe <PlayerState>
SPECTrum:HISTory:PLAYer:STATe <PlayerState>
CHANnel<m>:HISTory:PLAYer:STATe <PlayerState>

Starts and stops the replay of the history segments.

Parameters:

<PlayerState> RUN | STOP
 *RST: STOP

15.6.5.3 Timestamps

You can query the timestamps of history segments in two ways:

- Query for the timestamps of all history segments using `...:HISTory:...:ALL` commands.
- Query for the timestamp of a specific segment using `...:HISTory:...:com-` commands. Select the segment of interest using `CHANnel<m>:HISTory:CURRent` appropriate command.

The commands in this chapter use numeric suffixes:

- `CHANnel<m>`: Selects the analog input channel.
- `DIGital<m>`: Selects the logic channel, range 0..15
- `LOGic<p>`: Selects the logic pod, range 1..2
- `BUS`: Selects the bus, range 1..4

<code>CALCulate:MATH<m>:HISTory:TTABLE[:ENABLE]</code>	345
<code>BUS:HISTory:TTABLE[:ENABLE]</code>	345
<code>DIGital<m>:HISTory:TTABLE[:ENABLE]</code>	345
<code>LOGic<p>:HISTory:TTABLE[:ENABLE]</code>	345
<code>CHANnel<m>:HISTory:TTABLE[:ENABLE]</code>	345
<code>CALCulate:MATH<m>:HISTory:TSRelative?</code>	345
<code>BUS:HISTory:TSRelative?</code>	345
<code>DIGital<m>:HISTory:TSRelative?</code>	345
<code>LOGic<p>:HISTory:TSRelative?</code>	345
<code>SPECTrum:HISTory:TSRelative?</code>	346
<code>CHANnel<m>:HISTory:TSRelative?</code>	346

CALCulate:MATH<m>:HISTory:TSRelative:ALL?	346
BUS:HISTory:TSRelative:ALL?	346
DIGital<m>:HISTory:TSRelative:ALL?	346
LOGic<p>:HISTory:TSRelative:ALL?	346
SPECtrum:HISTory:TSRelative:ALL?	346
CHANnel<m>:HISTory:TSRelative:ALL?	346
CALCulate:MATH<m>:HISTory:TSABsolute?	346
BUS:HISTory:TSABsolute?	346
DIGital<m>:HISTory:TSABsolute?	346
LOGic<p>:HISTory:TSABsolute?	346
SPECtrum:HISTory:TSABsolute?	346
CHANnel<m>:HISTory:TSABsolute?	346
CALCulate:MATH<m>:HISTory:TSABsolute:ALL?	347
BUS:HISTory:TSABsolute:ALL?	347
DIGital<m>:HISTory:TSABsolute:ALL?	347
LOGic<p>:HISTory:TSABsolute:ALL?	347
SPECtrum:HISTory:TSABsolute:ALL?	347
CHANnel<m>:HISTory:TSABsolute:ALL?	347
CALCulate:MATH<m>:HISTory:TSDate?	347
BUS:HISTory:TSDate?	347
DIGital<m>:HISTory:TSDate?	347
LOGic<p>:HISTory:TSDate?	347
SPECtrum:HISTory:TSDate?	347
CHANnel<m>:HISTory:TSDate?	347
CALCulate:MATH<m>:HISTory:TSDate:ALL?	347
BUS:HISTory:TSDate:ALL?	347
DIGital<m>:HISTory:TSDate:ALL?	347
LOGic<p>:HISTory:TSDate:ALL?	347
SPECtrum:HISTory:TSDate:ALL?	347
CHANnel<m>:HISTory:TSDate:ALL?	347

CALCulate:MATH<m>:HISTory:TTABLE[:ENABLE] <TimeTableEnable>

BUS:HISTory:TTABLE[:ENABLE] <TimeTableEnable>

DIGital<m>:HISTory:TTABLE[:ENABLE] <TimeTableEnable>

LOGic<p>:HISTory:TTABLE[:ENABLE] <TimeTableEnable>

CHANnel<m>:HISTory:TTABLE[:ENABLE] <TimeTableEnable>

Displays or hides the segment table on the screen.

Parameters:

<TimeTableEnable> ON | OFF

*RST: OFF

CALCulate:MATH<m>:HISTory:TSRelative?

BUS:HISTory:TSRelative?

DIGital<m>:HISTory:TSRelative?

LOGic<p>:HISTory:TSRelative?

SPECTrum:HISTory:TSRelative?
CHANnel<m>:HISTory:TSRelative?

Returns the time difference of the selected segment to the newest segment. To select a segment, use [CHANnel<m>:HISTory:CURRent](#).

Return values:

<TimeToNewestAcq> Time to newest acquisition

Example:

```
CHAN:HIST:CURR -5
CHAN:HIST:TSR?
--> -1.138757760000E-02
```

Returns the relative time of the sixth segment. The newest segment has index 0.

Usage: Query only

CALCulate:MATH<m>:HISTory:TSRelative:ALL?
BUS:HISTory:TSRelative:ALL?
DIGital<m>:HISTory:TSRelative:ALL?
LOGic<p>:HISTory:TSRelative:ALL?
SPECTrum:HISTory:TSRelative:ALL?
CHANnel<m>:HISTory:TSRelative:ALL?

Returns the time differences to the newest acquisition of all history segments.

Return values:

<TimeToNewestAcq> List of Values

The list starts with the oldest segment, and the newest segment is the last one.

Example:

```
CHANnel2:HISTory:TSRelative:ALL?
--> -4.184565632000E-01,-4.094896352000E-01,-4.005227104000E-01,
-3.915557824000E-01, ..., -8.966924800000E-03,-0.000000000000E+00
```

Usage: Query only

CALCulate:MATH<m>:HISTory:TSABsolute?
BUS:HISTory:TSABsolute?
DIGital<m>:HISTory:TSABsolute?
LOGic<p>:HISTory:TSABsolute?
SPECTrum:HISTory:TSABsolute?
CHANnel<m>:HISTory:TSABsolute?

Returns the absolute daytime of the selected acquisition ([CHANnel<m>:HISTory:CURRent](#)).

Return values:

<Hour>, <Minute>, <Seconds> Comma-separated list

Example:

```
CHAN:HIST:CURR -1
CHAN:HIST:TSAB?
--> 16,24,3.302100000000E+01
```

Usage: Query only

CALCulate:MATH<m>:HISTory:TSABsolute:ALL?
BUS:HISTory:TSABsolute:ALL?
DIGital<m>:HISTory:TSABsolute:ALL?
LOGic<p>:HISTory:TSABsolute:ALL?
SPECtrum:HISTory:TSABsolute:ALL?
CHANnel<m>:HISTory:TSABsolute:ALL?

Returns the absolute daytimes of all history segments.

Return values:

<Hour>, <Minute>, <Second> Comma-separated list of hour, minute, and second values.

Example:

```
CHANnel2:HISTory:TSABsolute:ALL?
--> 14,59,4.558154343680E+01,14,59,4.559051036480E+01,
14,59,4.559947728960E+01,...
```

Usage: Query only

CALCulate:MATH<m>:HISTory:TSDate?
BUS:HISTory:TSDate?
DIGital<m>:HISTory:TSDate?
LOGic<p>:HISTory:TSDate?
SPECtrum:HISTory:TSDate?
CHANnel<m>:HISTory:TSDate?

Returns the date of the selected acquisition ([CHANnel<m>:HISTory:CURRent](#)).

Return values:

<Year>, <Month>, <Day> Comma-separated list

Example:

```
CHAN:HIST:CURR -5
CHAN:HIST:TSD?
--> 2014,7,1
```

Usage: Query only

CALCulate:MATH<m>:HISTory:TSDate:ALL?
BUS:HISTory:TSDate:ALL?
DIGital<m>:HISTory:TSDate:ALL?
LOGic<p>:HISTory:TSDate:ALL?
SPECtrum:HISTory:TSDate:ALL?
CHANnel<m>:HISTory:TSDate:ALL?

Returns the dates of all history segments.

Return values:

<Year>, <Month>, <Day>
 Comma-separated list of year, month, and day values.
 The list starts with the oldest segment, and the newest segment is the last one.

Example:

```
CHANnel2:HISTory:TSDate:ALL?
--> 2014,11,26,2014,11,26,2014,11,26,2014,11,26,...
```

Usage:

Query only

15.6.5.4 Export of History Data

The commands in this chapter use numeric suffixes:

- CHANnel<m>: Selects the analog input channel.
- DIGital<m>: Selects the logic channel, range 0..15
- LOGic<p>: Selects the logic pod, range 1..2
- BUS: Selects the bus, range 1..4

BPLot:EXPort:NAME.....	348
BUS:HISTory:EXPort:NAME.....	348
DIGital<m>:HISTory:EXPort:NAME.....	348
SPECtrum:HISTory:EXPort:NAME.....	348
CHANnel<m>:HISTory:EXPort:NAME.....	348
EXPort:ATABLE:NAME.....	348
BPLot:EXPort:SAVE.....	348
BUS:HISTory:EXPort:SAVE.....	348
DIGital<m>:HISTory:EXPort:SAVE.....	348
SPECtrum:HISTory:EXPort:SAVE.....	348
CHANnel<m>:HISTory:EXPort:SAVE.....	349
EXPort:ATABLE:SAVE.....	349

BPLot:EXPort:NAME

BUS:HISTory:EXPort:NAME <ExportPath>

DIGital<m>:HISTory:EXPort:NAME <ExportPath>

SPECtrum:HISTory:EXPort:NAME <ExportPath>

CHANnel<m>:HISTory:EXPort:NAME <ExportPath>

EXPort:ATABLE:NAME <ExportPath>

Parameters:

<ExportPath> String parameter

Example:

```
EXPort:ATABLE:NAME "/USB_FRONT/EXPORT/TIMES"
```

BPLot:EXPort:SAVE

BUS:HISTory:EXPort:SAVE

DIGital<m>:HISTory:EXPort:SAVE

SPECtrum:HISTory:EXPort:SAVE

CHANnel<m>:HISTory:EXPort:SAVE EXPort:ATABLE:SAVE

Saves the acquisition timestamps table to the file that is defined by the `EXPort:ATABLE:NAME` command.

Example: `EXPort:ATABLE:SAVE`

The file contains the following timestamp values:

```

"", "Date", "Time"
"Start of Acquisition", "2014-11-24", "14:35:59"
"Last Acquisition", "2014-11-24", "14:36:01"
"Acquisitions", "150"

"Number", "Relative Time", "Time to previous",
"Date", "Time", "Trigger"
"0", "-0.0000000000000000E+00", "1.0096384000000000E-02",
"2014-11-24", "14:36:01", "0.000000000000E+00", Trg'd
"-1", "-1.0096384000000000E-02", "2.0005688000000000E-02",
"2014-11-24", "14:36:00", "9.89903616000E-01", Trg'd
"-2", "-3.0102072000000000E-02", "2.0002168000000000E-02",
"2014-11-24", "14:36:00", "9.69897928000E-01", Trg'd
"-3", "-5.0104240000000000E-02", "2.0014232000000000E-02",
"2014-11-24", "14:36:00", "9.49895760000E-01", Trg'd
"-4", "-7.0118472000000000E-02", "2.0000440000000000E-02",
"2014-11-24", "14:36:00", "9.29881528000E-01", Trg'd
"-5", "-9.0118912000000001E-02", "9.9174120000000000E-03",
"2014-11-24", "14:36:00", "9.09881088000E-01", Trg'd
"-6", "-1.0003632400000000E-01", "1.0096860000000000E-02",
"2014-11-24", "14:36:00", "8.99963676000E-01", Trg'd....

```

Usage: `Event`

15.7 Measurements

15.7.1 Quick Measurements

In the quick measurement commands, the numeric suffix <m> is irrelevant, omit it.

<code>MEASurement<m>:AON</code>	349
<code>MEASurement<m>:AOFF</code>	350
<code>MEASurement<m>:ARESult?</code>	350
<code>MEASurement<m>:ALL[:STATe]</code>	350

`MEASurement<m>:AON`

Starts the quick measurement.

Usage: Event

MEASurement<m>:AOFF

Stops the quick measurement.

Usage: Event

MEASurement<m>:AREsult?

Returns the results of the quick measurement.

Return values:

<Data> List of values
 Quick measurement results are listed in the following order:
 PEAK (Vpp), UPE (Vp+), LPE (Vp-), CYCR (RMS-Cyc), CYCM (MeanCyc), PER (T), FREQ (f), RTIM (tr), FTIM (tf).

Usage: Query only

MEASurement<m>:ALL[:STATe]

Starts or stops the quick measurement and sets the status bit.

Suffix:

<m> 1..4
 The suffix is irrelevant.

Parameters:

<State> ON | OFF
 *RST: OFF

15.7.2 Automatic Measurements

15.7.2.1 Measurement Settings

MEASurement<m>[:ENABLE].....	350
MEASurement<m>:MAIN.....	351
MEASurement<m>:SOURce.....	353
MEASurement<m>:DELay:SLOPe.....	353
MEASurement<m>:STATistics[:ENABLE].....	353
MEASurement<m>:STATistics:RESet.....	354

MEASurement<m>[:ENABLE] <State>

Activates or deactivates the selected measurement.

Suffix:

<m> 1..4
Selects the measurement place.

Parameters:

<State> ON | OFF
*RST: OFF

MEASurement<m>:MAIN <MeasType>

Defines the measurement type to be performed on the selected source. To query the results, use `MEASurement<m>:RESult[:ACTual]?`.

Suffix:

<m> 1..4
Selects the measurement.

Parameters:

<MeasType> FREQuency | PERiod | PEAK | UPEakvalue | LPEakvalue |
PPCount | NPCount | RECount | FECount | HIGH | LOW |
AMPLitude | MEAN | RMS | RTIME | FTIME | PDCYcle |
NDCYcle | PPWidth | NPWidth | CYCMean | CYCRms |
STDDev | CYCStddev | DELay | PHASe | BWIDth |
POVershoot | NOVershoot

See also: [Chapter 7.2.2, "Measurement Types"](#), on page 114.

FREQuency

Frequency of the signal. The result is based on the length of the left-most signal period within the displayed section of the waveform of the selected channel.

PERiod

Length of the left-most signal period within the displayed section of the waveform of the selected channel.

PEAK

Peak-to-peak value within the displayed section of the waveform of the selected channel.

UPEakvalue

Maximum (upper) value within the displayed section of the waveform of the selected channel.

LPEakvalue

Minimum (lower) value within the displayed section of the waveform of the selected channel.

PPCount | NPCount

Counts positive or negative pulses.

RECount | FECount

Counts the number of rising or falling edges.

HIGH | LOW

Mean value of the high or low level of a square wave.

AMPLitude

Amplitude of a square wave.

MEAN

Mean voltage value of the complete displayed waveform of the selected channel.

RMS

RMS (root mean square) voltage value of the complete displayed waveform of the selected channel.

RTIME | FTIME

Rise or falling time of the left-most rising edge within the displayed section of the waveform of the selected channel. The reference level for this measurement is set with `REFLevel:RELAtive:MODE`.

PDCycle | NDCycle

Positive or negative duty cycle.

PPWidth | NPWidth

Width of positive or negative pulses.

CYCMean

Mean voltage value of the left-most signal period of the waveform of the selected channel.

CYCRms

RMS (root mean square) voltage value of the left-most signal period of the waveform of the selected channel.

STDDev

Standard deviation of the waveform.

CYCStddev

Standard deviation of one cycle, usually of the first, left-most signal period.

DELay

Time difference between two edges of the same or different waveforms. The waveforms are selected with `MEASurement<m>:SOURce`, and the edges with `MEASurement<m>:DELay:SLOPe`.

PHASe

Phase difference between two waveforms (time difference/period * 360). The waveforms are selected with `MEASurement<m>:SOURce`.

BWIDTH

Burst width, the duration of one burst, measured from the first edge to the last edge that crosses the middle reference level.

POVershoot | NOVershoot

Positive and negative overshoot of a square wave.

*RST: PEAK

MEASurement<m>:SOURce <SignalSource>[,<SignalSource2>]

Selects one of the active signal, reference or math channels as the source(s) of the selected measurement. Available sources depend on the selected measurement type.

Suffix:

<m> 1..4
Selects the measurement place.

Parameters:

<SignalSource> CH1..4 | MA1 | RE1..4 | D0..15
Waveform to be measured, required for all measurement types. For delay and phase measurements, it is the "Measure Source".

CH1 | CH2 | CH3 | CH4

Active signal channels 1 to 4

MA1

Active math channel

RE1 | RE2 | RE3 | RE4

Active reference channels 1 to 4

D0..D15

Active digital channels D0...D15. Only available, if MSO option R&S RTB-B1 is installed.

<SignalSource2> None | CH1..4 | MA1 | RE1..4 | D0..15
Second waveform, reference source that is required for delay and phase measurements ("Measure Source 2").

MEASurement<m>:DELay:SLOPe <SignalSlope>,<ReferenceSlope>

Sets the edges to be used for delay measurement. The associated waveforms are defined with [MEASurement<m>:SOURce](#).

Parameters:

<SignalSlope> POSitive | NEGative
Slope of first waveform ("Measure Source").
*RST: POS

<ReferenceSlope> POSitive | NEGative
Slope of the reference waveform ("Measure Source 2").
*RST: POS

MEASurement<m>:STATistics[:ENABLE] <StatisticEnable>

Activates or deactivates the statistical evaluation for all active measurements.

Suffix:

<m> 1..4
The suffix is irrelevant.

Parameters:

<StatisticEnable> ON | OFF
 *RST: OFF

MEASurement<m>:STATistics:RESet

Deletes the statistical results for all measurements, and starts a new statistical evaluation if the acquisition is running. The waveform count is set to 0 and all measurement values are set to NAN.

Suffix:

<m> 1..4
 The suffix is irrelevant.

Usage: Event

15.7.2.2 Measurements Results

You can query the statistical results using the `MEAS : STAT` commands.

To export statistical results to a csv file, use the `EXP : MEAS : STAT` commands. Note that export of statistics is possible only remotely, but not in manual operation.

<code>MEASurement<m>:RESult[:ACTual]?</code>	354
<code>MEASurement<m>:RESult:AVG?</code>	355
<code>MEASurement<m>:RESult:STDDev?</code>	355
<code>MEASurement<m>:RESult:NPEak?</code>	355
<code>MEASurement<m>:RESult:PPEak?</code>	356
<code>MEASurement<m>:RESult:WFMCount?</code>	356
<code>MEASurement<m>:STATistics:WEIGHT?</code>	356
<code>MEASurement<m>:STATistics:VALue:ALL?</code>	356
<code>MEASurement<m>:STATistics:VALue<n>?</code>	357
<code>EXPort:MEASurement<m>:STATistics:NAME</code>	357
<code>EXPort:MEASurement<m>:STATistics:SAVE</code>	357
<code>EXPort:MEASurement:STATistics:ALL:NAME</code>	358
<code>EXPort:MEASurement:STATistics:ALL:SAVE</code>	358

MEASurement<m>:RESult[:ACTual]? [<MeasType>]

Returns the result of the specified measurement type.

Suffix:

<m> 1..4
 Selects the measurement place.

Query parameters:

<MeasType> FREQuency | PERiod | PEAK | UPEakvalue | LPEakvalue |
 PPCount | NPCount | RECount | FECount | HIGH | LOW |
 AMPLitude | MEAN | RMS | RTIME | FTIME | PDCYcle |
 NDCYcle | PPWidth | NPWidth | CYCMean | CYCRms |
 STDDev | CYCStddev | DELay | PHASe | BWIDth |
 POVershoot | NOVershoot

Specifies the measurement type, see [MEASurement<m>:MAIN](#) on page 351. If you omit the parameter, the result of the last measurement setup is returned.

Return values:

<Value> Measurement result. If no measurement was executed, no value (NAN) is returned.

Usage: Query only

MEASurement<m>:RESult:AVG? <AverageValue>

Returns the average value of the current measurement series.

Suffix:

<m> 1..4
 Selects the measurement place.

Query parameters:

<AverageValue> Statistic value

Usage: Query only

MEASurement<m>:RESult:STDDev? <StandardDeviation>

Returns the statistical standard deviation of the current measurement series.

Suffix:

<m> 1..4
 Selects the measurement place.

Query parameters:

<StandardDeviation> Statistic value

Usage: Query only

MEASurement<m>:RESult:NPEak? <NegativePeak>

Returns the minimum measurement result of the current measurement series.

Suffix:

<m> 1..4
 Selects the measurement place.

Query parameters:

<NegativePeak> Minimum measurement result

Usage: Query only

MEASurement<m>:RESult:PPEak? <PositivePeak>

Returns the maximum measurement result of the current measurement series.

Suffix:

<m> 1..4
Selects the measurement place.

Query parameters:

<PositivePeak> Maximum measurement result

Usage: Query only

MEASurement<m>:RESult:WFMCount? <WaveformCount>

Returns the current number of measured waveforms.

The query for MIN and MAX values is not possible.

Suffix:

<m> 1..4
Selects the measurement place.

Query parameters:

<WaveformCount> Number of measured waveforms

Usage: Query only

MEASurement<m>:STATistics:WEIGht? <BufferSize>

Returns the size of the statistics buffer.

Suffix:

<m> 1..4
Selects the measurement place.

Return values:

<BufferSize> The buffer size is always 1000 result values.

Usage: Query only

MEASurement<m>:STATistics:VALue:ALL?

Returns all values from the statistics buffer.

Note: Valid buffered values can only be read if the acquisition is stopped. As long as the acquisition is running, the buffer contents is changing and the buffered values are not valid for reading.

Suffix:

<m> 1..4
Selects the measurement place.

Return values:

<ValueList> Comma separated List of Values
 Comma-separated list of statistical values

Usage: Query only

MEASurement<m>:STATistics:VALue<n>?

Returns the n^{th} statistical value from the indicated buffer place.

Note: Valid buffered values can only be read if the acquisition is stopped. As long as the acquisition is running, the buffer contents is changing and the buffered values are not valid for reading.

Suffix:

<m> 1..4
 Selects the measurement place.

<n> *
 Buffer place. The buffer size is 1000 results.

Return values:

<StatisticValue> Statistical value

Usage: Query only

EXPort:MEASurement<m>:STATistics:NAME

Defines the path and filename of the statistics file. The file format is CSV. If the file already exists, it will be overwritten without notice.

Suffix:

<m> 1..4
 Selects the measurement place.

Parameters:

<FileName> String parameter

EXPort:MEASurement<m>:STATistics:SAVE

Saves statistical results of the indicated measurement place to the file that is defined by the [EXPort:MEASurement<m>:STATistics:NAME](#) command.

Suffix:

<m> 1..4
 Selects the measurement place.

Usage: Event

See also: [EXPort:MEASurement:STATistics:ALL:SAVE](#) on page 358.

EXPort:MEASurement:STATistics:ALL:NAME

Defines the path and filename of the statistics file. The file format is CSV. If the file already exists, it will be overwritten.

Parameters:

<FileName> String parameter

EXPort:MEASurement:STATistics:ALL:SAVE

Saves statistical results of all measurement places to the file that is defined by the [EXPort:MEASurement:STATistics:ALL:NAME](#) command.

Example:

The file contains general information, statistical results, long term statistics, and the individual values that are used to calculate the statistics. The number of values is "Average No."

```
"Vendor", "Rohde&Schwarz",
"Device/Mat.-No.", "RTB2004 / 1333.1005K04",
"Serial No.", "3900001",
"Firmware Version", "02.001",
>Date", "2017-11-18 / 16:40:27",

"Meas. Place", "1", "2", "3",
"Type", "Frequency", "Mean Value", "Frequency",
"Source 1", "CH1", "CH1", "CH2",
"Source 2",
"Wave count", 42, 39, 37,
"Current", 4.998250e+05, 5.648727e-01, 4.998250e+05,
"Average No.", 1.000000e+03, 1.000000e+03, 1.000000e+03,
"Minimum", 4.997501e+05, 5.633875e-01, 4.997501e+05,
"Maximum", 4.998250e+05, 5.650349e-01, 4.998250e+05,
"Mean", 4.998179e+05, 5.642045e-01, 4.998169e+05,
"σ-Deviation", 2.199706e+01, 3.677224e-04, 2.326898e+01,
"Time of first value",
"Time of last value",
"Long term Minimum", 4.997501e+05, 5.633875e-01, 4.997501e+05,
"Long term Maximum", 4.998250e+05, 5.650349e-01, 4.998250e+05,
"Long term Mittelwert", 4.998179e+05, 5.642045e-01, 4.998169e+05,
"Long term σ-Deviation", 2.226370e+01, 3.725295e-04, 2.358995e+01,
"Long term start time",
"Long term end Time",

"Index", "Time Offset", "Value", "Time Offset", "Value",
"Time Offset", "Value",
1, 4.998250e+05, 5.649274e-01, 4.997501e+05,
2, 4.998250e+05, 5.649072e-01, 4.998250e+05,
3, 4.998250e+05, 5.650349e-01, 4.998250e+05,
4, 4.998250e+05, 5.641094e-01, 4.998250e+05,
5, 4.998250e+05, 5.640586e-01, 4.998250e+05,
6, 4.997501e+05, 5.642784e-01, 4.998250e+05,
7, 4.998250e+05, 5.637245e-01, 4.998250e+05, ...
```

Usage: Event

15.7.2.3 Measurement Gate

MEASurement<m>:GATE.....	359
MEASurement<m>:GATE:MODE.....	359
MEASurement<m>:GATE:ABSolute:START.....	359
MEASurement<m>:GATE:ABSolute:STOP.....	359
MEASurement<m>:GATE:RELative:START.....	360
MEASurement<m>:GATE:RELative:STOP.....	360

MEASurement<m>:GATE <State>

Activates or deactivates the measurement gate.

To set the gate, use:

- MEASurement<m>:GATE:MODE and
- MEASurement<m>:GATE:ABSolute:START and MEASurement<m>:GATE:ABSolute:STOP
- or MEASurement<m>:GATE:RELative:START and MEASurement<m>:GATE:RELative:STOP

Suffix:

<m> 1..4
Selects the measurement place.

Parameters:

<State> ON | OFF
*RST: OFF

MEASurement<m>:GATE:MODE <GateMode>

Defines whether the gate is defined in absolute or relative values.

Suffix:

<m> 1..4
The suffix is irrelevant. One gate is used for all measurement places.

Parameters:

<GateMode> RELative | ABSolute
*RST: REL

MEASurement<m>:GATE:ABSolute:START <Time>

MEASurement<m>:GATE:ABSolute:STOP <Time>

Define the absolute start and end time for the measurement gate, respectively.

Suffix:

<m> 1..4
The suffix is irrelevant. One gate is used for all measurement places.

Parameters:

<Time> *RST: 300e-6
Default unit: s

MEASurement<m>:GATE:RELative:STARt <Position>

MEASurement<m>:GATE:RELative:STOP <Position>

Define the relative start and end values for the measurement gate, respectively.

Suffix:

<m> 1..4
The suffix is irrelevant. One gate is used for all measurement places.

Parameters:

<Position> *RST: 75
Default unit: %

15.7.2.4 Reference Levels

REFLevel:RELative:MODE.....	360
REFLevel:RELative:LOWer.....	361
REFLevel:RELative:UPPer.....	361
REFLevel:RELative:MIDDLE.....	361

REFLevel:RELative:MODE <RelativeMode>

Sets the lower and upper reference levels for rise and fall time measurements (cursor and automatic measurements) as well as the middle reference level for phase and delay measurements. The levels are defined as percentages of the high signal level. The setting is valid for all measurement places.

Parameters:

<RelativeMode> TEN | TWENTy | FIVE | USER
TEN: 10, 50 and 90%
TWENTy: 20, 50 and 80%
FIVE: 5, 50 and 95 %
USER: levels are defined with [REFLevel:RELative:LOWer](#),
[REFLevel:RELative:MIDDLE](#) and [REFLevel:RELative:UPPer](#).
*RST: TEN

Example:

```
REFL:REL:MODE TWENTy
MEAS2:MAIN RTIM
```

Sets the reference levels for all measurements and measures the rise time between these levels for measurement place 2:
 lower reference level = 20% of high signal level
 upper reference level = 80% of high signal level

REFLevel:RELative:LOWer <LowerLevel>

REFLevel:RELative:UPPer <UpperLevel>

Set the lower and upper reference levels for rise and fall time measurements (cursor and automatic measurements) if **REFLevel:RELative:MODE** is set to **USER**. The levels are defined as percentages of the high signal level. They are valid for all measurements.

Parameters:

<LowerLevel>	*RST: 10
	Default unit: %
<UpperLevel>	*RST: 90
	Default unit: %

REFLevel:RELative:MIDDLE <MiddleLevel>

Set the middle reference level that is used for phase and delay measurements, if **REFLevel:RELative:MODE** is set to **USER**. The level is defined as percentages of the high signal level. The setting is valid for all measurements.

Parameters:

<MiddleLevel>	*RST: 50
	Default unit: %

15.7.3 Cursor Measurements

15.7.3.1 Cursor Settings

CURSor<m>:AOFF.....	362
CURSor<m>:STATe.....	362
CURSor<m>:FUNCTion.....	362
CURSor<m>:SOURce.....	363
CURSor<m>:TRACking[:STATe].....	364
CURSor<m>:X1Position.....	364
CURSor<m>:X2Position.....	364
CURSor<m>:Y1Position.....	364
CURSor<m>:Y2Position.....	364
CURSor<m>:YCOupling.....	364
CURSor<m>:XCOupling.....	364
CURSor<m>:SWAVE.....	365

CURSor<m>:TRACking:SCALe[:STATe]	365
CURSor<m>:SSCReen	365
CURSor<m>:SPPeak<n>	365
CURSor<m>:SNPeak<n>	365

CURSor<m>:AOFF

Switches the cursor off.

Suffix:

<m> 1, the suffix is irrelevant.

Usage: Event

CURSor<m>:STATe <State>

Activates or deactivates the cursor measurement.

Suffix:

<m> 1, the suffix is irrelevant.

Parameters:

<State> ON | OFF
*RST: OFF

CURSor<m>:FUNCTion <Type>

Defines the cursor measurement type.

Suffix:

<m> 1, the suffix is irrelevant.

Parameters:

<Type> HORizontal | VERTical | HVERTical
To set the V-marker measurement, use [CURSor<m>:TRACking\[:STATe\]](#).
*RST: VERTical

Value	Description	Queries for results
HORizontal	Sets two horizontal cursor lines and measures the voltages at the two cursor positions and the delta of the two values.	<code>CURSor<m>:Y1Position</code> <code>CURSor<m>:Y2Position</code> <code>CURSor<m>:YDELta[:VALue]?</code> <code>CURSor<m>:YDELta:SLOPe?</code>
VERTical	Sets two vertical cursor lines and measures the time from the trigger point to each cursor, the time between the two cursors and the frequency calculated from that time.	<code>CURSor<m>:X1Position</code> <code>CURSor<m>:X2Position</code> <code>CURSor<m>:XDELta[:VALue]?</code> <code>CURSor<m>:XDELta:INVerse?</code>
HVERTical	Combines the HORizontal cursor and VERTical cursor measurements. Two horizontal and two vertical cursor lines are set and the voltages and time from the trigger point are measured at the cursor positions, as well as the delta of the voltage and time values.	<code>CURSor<m>:Y1Position</code> <code>CURSor<m>:Y2Position</code> <code>CURSor<m>:YDELta[:VALue]?</code> <code>CURSor<m>:X1Position</code> <code>CURSor<m>:X2Position</code> <code>CURSor<m>:XDELta[:VALue]?</code>

CURSor<m>:SOURce <Source>

Defines the source of the cursor measurement.

Suffix:

<m> 1, the suffix is irrelevant.

Parameters:

<Source> CH1 | CH2 | CH3 | CH4 | MA1 | MA2 | MA3 | MA4 | MA5 | RE1 | RE2 | RE3 | RE4 | XY1 | XY2 | D70 | D158 | D0..15 | SPECtrum | MINHold | MAXHold | AVERage

CH1 | CH2 | CH3 | CH4

Active analog channel waveforms 1 to 4

MA1 | MA2 | MA3 | MA4 | MA5

Active math waveforms 1 to 5

RE1 | RE2 | RE3 | RE4

Active reference waveform 1 to 4

XY1 | XY2

Active XY-waveforms

D0..15

Active digital channels D0 to D15, available if MSO option R&S RTB-B1 is installed.

On individual digital channels, only vertical (time) cursor measurements are possible.

D70 | D158

Active digital channels D0...D7 (pod 1) and D8...D15 (pod 2).

Only available, if MSO option R&S RTB-B1 is installed. On pods, only V-marker measurement is possible.

SPECTrum | MINHold | MAXHold | AVERAge
FFT waveforms

CURSor<m>:TRACkING[:STATe] <State>

If set to ON, the V-Marker cursor measurement is enabled.

Suffix:

<m> 1, the suffix is irrelevant.

Parameters:

<State> ON | OFF
*RST: OFF

CURSor<m>:X1Position <Xposition1>

CURSor<m>:X2Position <Xposition2>

The commands specify or return the positions of vertical cursor lines on the x-axis (time, frequency for FFT).

Suffix:

<m> 1, the suffix is irrelevant.

Parameters:

<Xposition1> Range: Depends on the current instrument settings, for
<Xposition2> example, horizontal position.
Default unit: s

CURSor<m>:Y1Position <Yposition1>

CURSor<m>:Y2Position <Yposition2>

The commands specify or return the positions of horizontal cursor lines on the y-axis (voltage, current, level for FFT).

Suffix:

<m> 1, the suffix is irrelevant.

Parameters:

<Yposition2> Range: Depends on the current instrument settings.
Increment: 0.01
Default unit: V

CURSor<m>:YCOupling <Coupling>

CURSor<m>:XCOupling <Coupling>

If enabled, the cursor lines are coupled so that the distance between the two lines remains the same if one cursor is moved.

Suffix:

<m> 1, the suffix is irrelevant.

Parameters:

<Coupling> ON | OFF
 *RST: OFF

CURSor<m>:SWAVe

Autoset for cursor lines, sets the cursor lines to typical points of the waveform depending on the selected cursor type. For example, for voltage measurement ("Horizontal"), the cursor lines are set to the upper and lower peaks of the waveform. For time measurement ("Vertical"), the cursor lines are set to the edges of two consecutive positive or two consecutive negative pulses.

Suffix:

<m> 1, the suffix is irrelevant.

Usage: Event

CURSor<m>:TRACking:SCALe[:STATe] <State>

Enables the adjustment of cursor lines if the vertical or horizontal scales are changed.

Suffix:

<m> 1, the suffix is irrelevant.

Parameters:

<State> ON | OFF
ON
 Cursor lines keep their relative position to the waveform.
OFF
 Cursor lines remain on their position on the display if the scaling is changed.
 *RST: OFF

CURSor<m>:SSCReen

Resets the cursors to their initial positions. This is helpful if the cursors have disappeared from the display or need to be moved for a larger distance.

Suffix:

<m> 1, the suffix is irrelevant.

Usage: Event

CURSor<m>:SPPeak<n>**CURSor<m>:SNPeak<n>**

Set the cursor line to the previous / next peak, respectively. The command is only available for FFT waveforms.

Suffix:

<m> 1, the suffix is irrelevant.

<n> 1..2
Selects the cursor line.

Usage: Event

15.7.3.2 Cursor Measurement Results

To get the measurement values of vertical cursor lines (time, frequency for FFT), use:

- `CURSor<m>:X1Position` on page 364
- `CURSor<m>:X2Position` on page 364

To get the measurement values of horizontal cursor lines (voltage, current, level for FFT), use:

- `CURSor<m>:Y1Position` on page 364
- `CURSor<m>:Y2Position` on page 364

<code>CURSor<m>:XDELta[:VALue]?</code>	366
<code>CURSor<m>:XDELta:INVerse?</code>	366
<code>CURSor<m>:YDELta[:VALue]?</code>	366
<code>CURSor<m>:YDELta:SLOPe?</code>	367

`CURSor<m>:XDELta[:VALue]?`

Returns the time difference between two vertical cursor lines (Δt).

Suffix:

<m> 1, the suffix is irrelevant.

Return values:

<Delta> Range: -100E24 to 100E24
Increment: 0.1
Default unit: s

Usage: Query only

`CURSor<m>:XDELta:INVerse?`

Returns the inverse time difference between the two cursors ($1/\Delta t$, frequency).

Suffix:

<m> 1, the suffix is irrelevant.

Return values:

<DeltaInverse> Range: -100E24 to 100E24
Increment: 0.1
Default unit: 1/s

Usage: Query only

`CURSor<m>:YDELta[:VALue]?`

Queries the delta of the values in y-direction at the two cursor lines.

Suffix:
 <m> 1, the suffix is irrelevant.

Return values:
 <YDelta> Delta value

Usage: Query only

CURSor<m>:YDELta:SLOPe?

Returns the inverse value of the vertical difference (e.g. voltage difference) - the reciprocal of the vertical distance of two horizontal cursor lines: $1/\Delta V$.

Suffix:
 <m> 1, the suffix is irrelevant.

Return values:
 <Slope> Inverse value

Usage: Query only

15.8 Applications

15.8.1 General

DEVIce:MODE

Sets the operation mode or application.

Parameters:

<OperationalMode> YT | ZOOM | XY | QMEas | UPDate | AUToset | MASKtest | FFT

15.8.2 Mask Testing

15.8.2.1 Mask Setup

MASK:STATe.....	368
MASK:SOURce.....	368
MASK:CHCopy.....	368
MASK:YPOStion.....	368
MASK:YSCale.....	368
MASK:XWIDth.....	368
MASK:YWIDth.....	369
MASK:SAVE.....	369
MASK:LOAD.....	369

MASK:STATE <State>

Turns the mask test application on or off. When turning off, any temporarily stored masks are deleted.

Parameters:

<State> ON | OFF
*RST: OFF

MASK:SOURce <Source>

Defines the channel to be compared with the mask, and also the channel from which the mask is created.

Parameters:

<Source> CH1 | CH2 | CH3 | CH4
CH3 and CH4 are only available on 4-channel models.
*RST: CH1

MASK:CHCopy

Creates a mask from the envelope waveform of the source set with [MASK:SOURce](#).

Usage: Event

MASK:YPOSITION <Yposition>

Moves the mask vertically within the display.

Parameters:

<Yposition> Mask offset from the vertical center
Default unit: div

MASK:YScale <Yscale>

Changes the vertical scaling to stretch or compress the mask in y-direction.

Parameters:

<Yscale> A value over 100% stretches the amplitudes; a value less than 100% compresses the amplitudes.
Default unit: %

MASK:XWIDTH <Xaddition>

Changes the width of the mask in horizontal direction.

Parameters:

<Xaddition> The value is added to the positive x-values and subtracted from the negative x-values of the mask limits in relation to the mask center.
 Default unit: div

MASK:YWIDTH <Yaddition>

Changes the width of the mask in vertical direction.

Parameters:

<Yaddition> The value is added to the y-values of the upper mask limit and subtracted from the y-values of the lower mask limit.
 Default unit: div

MASK:SAVE <Filename>

Saves the current mask in the specified file.

Setting parameters:

<Filename> String parameter
 Path and file name

Usage: Setting only

MASK:LOAD <Filename>

Loads a stored mask from the specified file.

Setting parameters:

<Filename> String parameter
 Path and file name

Usage: Setting only

15.8.2.2 Actions on Violation

MASK:ACTion:SOUNd:EVENT:MODE.....	369
MASK:ACTion:STOP:EVENT:MODE.....	369
MASK:ACTion:SCRSave:EVENT:MODE.....	370
MASK:ACTion:WFMSave:EVENT:MODE.....	370
MASK:ACTion:PULSe:EVENT:MODE.....	370
MASK:ACTion:STOP:EVENT:COUNT.....	370
MASK:ACTion:SCRSave:DESTination.....	370
MASK:ACTion:WFMSave:DESTination.....	371
MASK:ACTion:YOUT:ENABLE.....	371

MASK:ACTion:SOUNd:EVENT:MODE <EventMode>

MASK:ACTion:STOP:EVENT:MODE <EventMode>

MASK:ACTion:SCRSave:EVENT:MODE <EventMode>

MASK:ACTion:WFMSave:EVENT:MODE <EventMode>

MASK:ACTion:PULSe:EVENT:MODE <EventMode>

Defines when and how often the action is executed.

- **SOUNd**: Generates a beep sound on mask violation.
- **STOP**: Stops the waveform acquisition, after mask is violated for a defined number of times. You can set how many times with the command **MASK:ACTion:STOP:EVENT:COUNT**.
- **PULSe**: Creates a pulse on the [Aux Out] connector. This selection sets the configuration of the [Aux Out] connector to "Mask Violation".
- **SCRSave**: Saves a screenshot on mask violation. To set path and filename of the screenshot, use **MASK:ACTion:SCRSave:DESTination**.
- **WFMSave**: Saves the waveform data on mask violation. To set path and filename of the data file, use **MASK:ACTion:WFMSave:DESTination**.

Parameters:

<EventMode> OFF | EACH

OFF

No action is executed.

EACH

The selected action is executed on each violation of the mask.

*RST: OFF

MASK:ACTion:STOP:EVENT:COUNT <EventCount>

Sets the number of mask violations after which the action is executed.

Parameters:

<EventCount> Integer value, number of the violations that executes the action.

MASK:ACTion:SCRSave:DESTination <Path>

Defines the directory for a screenshot that is saved on mask violation. The file format is defined with **HCOP:LANG**. The filename is manually defined in the "File" > "Screenshots" dialog box and is incremented automatically, starting from 01.

Parameters:

<Path> String parameter

Example:

Prerequisite: a mask ist defined, and a waveform that hits the mask.

```
MASK:ACT:SCRS:DEST "/USB_FRONT/MASKS" //directory must exist
HCOPI:LANG PNG
MASK:ACT:SCRS:EVEN:MODE EACH
MASK:TEST RUN
RUN
```

On first violation, the screenshot is saved to <name>01.PNG, on second violation to <name>02.PNG, the third to <name>03.PNG ...

MASK:ACTion:WFMSave:DESTination <Path>

Defines the directory for waveform data files that are saved on mask violation. The file format is defined with `FORMAT`. The filename is manually defined in the "File" > "Waveforms" dialog box and is incremented automatically, starting from 01.

Parameters:

<Path> String parameter

Example:

Prerequisite: a mask ist defined, and a waveform that hits the mask.

```
MASK:ACT:WFMS:DEST "/USB_FRONT/MASKS" //directory must exist
FORM CSV,0
MASK:ACT:WFMS:EVEN:MODE EACH
MASK:TEST RUN
RUN
```

On first violation, the waveform data is saved to <name>01.CSV, on second violation to <name>02.CSV, the third to <name>03.CSV ...

MASK:ACTion:YOUT:ENABLE <Yout>

Creates a pulse on the [Aux Out] connector if the mask is violated. This selection sets the configuration of the [Aux Out] connector to "Mask Violation".

Same as [MASK:ACTion:PULSe:EVENT:MODE](#) on page 370.

Parameters:

<Yout> ON | OFF
*RST: OFF

15.8.2.3 Mask Test

MASK:TEST	372
MASK:RESet:COUNter	372
MASK:COUNt?	372
MASK:VCOunt?	372
MASK:CAPTure[:MODE]	372

MASK:TEST <Test>

Starts, finishes or interrupts a mask test.

Parameters:

<Test> RUN | STOP | PAUSE
 *RST: STOP

MASK:RESet:COUNTer

Sets the counters of passed and failed acquisitions to Zero.

Usage: Event

MASK:COUNT?

Returns the number of tested acquisitions.

Return values:

<TotalCount> Total number of tested acquisitions

Usage: Query only

MASK:VCOunt?

Returns the number of acquisitions that hit the mask.

Return values:

<ViolationCount> Total number of violations

Usage: Query only

MASK:CAPTure[:MODE] <CaptureMode>

Only available with history. The command selects whether all acquisitions are stored in segments, or only failed acquisition. You can use the history to analyze the segments.

Parameters:

<CaptureMode> ALL | FAILED
 *RST: ALL

15.8.2.4 Mask Data

Use the following commands that are described in [Chapter 15.9.1.5, "Masks"](#), on page 408:

- [MASK:DATA?](#) on page 408
- [MASK:DATA:HEADer?](#) on page 408
- [MASK:DATA:XINCrement?](#) on page 410
- [MASK:DATA:XORigin?](#) on page 409

- [MASK:DATA:YINCrement?](#) on page 411
- [MASK:DATA:YORigin?](#) on page 410
- [MASK:DATA:YRESolution?](#) on page 411

15.8.3 FFT Analysis

- [General Settings](#)..... 373
- [Frequency Settings](#)..... 375
- [Time Settings](#)..... 376
- [Waveform Settings](#)..... 377
- [Waveform Data](#)..... 378

15.8.3.1 General Settings

SPECTrum[:STATe]	373
SPECTrum:SOURce	373
SPECTrum:FREQUENCY:WINDow:TYPE	373
SPECTrum:FREQUENCY:MAGNitude:SCALe	374
SPECTrum:FREQUENCY:POSition	374
SPECTrum:FREQUENCY:SCALe	375
DISPlay:CBAR:FFT[:POSition]	375

SPECTrum[:STATe]

Switches on the spectrum analysis.

Parameters:

<State> ON | OFF

SPECTrum:SOURce

Selects the source for the spectrum analysis diagrams.

Parameters:

<Source> CH1 | CH2 | CH3 | CH4

SPECTrum:FREQUENCY:WINDow:TYPE

Window functions are multiplied with the input values and thus can improve the spectrum analysis display.

Parameters:

<WindowFunction> RECTangular | HAMMING | HANNing | BLACKmanharris |
FLATtop

RECTangular

The rectangular window has high frequency accuracy with thin spectral lines, but with increased noise. Use this function preferably with pulse response tests where start and end values are zero.

HAMMING

The Hamming window has higher noise level inside the spectrum than Hann or Blackman, but smaller than the rectangular window. The width of the spectral lines is thinner than the other bell-shaped functions. Use this window to measure amplitudes of a periodical signal precisely.

HANNING

The noise level within the spectrum is reduced and the width of the spectral lines enlarges. Use this window to measure amplitudes of a periodical signal precisely.

BLACKmanharris

In the Blackman window the amplitudes can be measured very precisely. However, determining the frequency is more difficult. Use this window to measure amplitudes of a periodical signal precisely.

FLATtop

The flat top window has low amplitude measurement errors but a poor frequency resolution. Use this window for accurate single-tone measurements and for measurement of amplitudes of sinusoidal frequency components.

SPECTrum:FREQUENCY:MAGNitude:SCALE <MagnitudeScale>

Defines the scaling unit of the y-axis.

Parameters:

<MagnitudeScale> LINear | DBM | DBV

LINear

Linear scaling, displays the RMS value of the voltage.

DBM

Logarithmic scaling, related to 1 mW.

DBV

Logarithmic scaling, related to 1 V_{eff}.

SPECTrum:FREQUENCY:POSition

Defines the vertical position of the spectrum.

Parameters:

<Position> Default unit: div

SPECTrum:FREQuency:SCALE

Sets the vertical scale of the spectrum analysis waveform.

Parameters:

<Scale> Range values and unit depend on [SPECTrum:FREQuency:MAGNitude:SCALE](#).

DISPlay:CBAR:FFT[:POSition] <DividerPosition>

Defines the position of the divide bar between normal waveform and FFT window.

Parameters:

<DividerPosition> Vertical position in pixel, measured from the top edge. The vertical display size is 800 px.
Default unit: px

15.8.3.2 Frequency Settings

SPECTrum:FREQuency:CENTer	375
SPECTrum:FREQuency:FULLspan	375
SPECTrum:FREQuency:SPAN	375
SPECTrum:FREQuency:START	376
SPECTrum:FREQuency:STOP	376
SPECTrum:FREQuency:BANDwidth[:RESolution][:VALue]	376
SPECTrum:FREQuency:BANDwidth[:RESolution]:RATio	376

SPECTrum:FREQuency:CENTer

Defines the position of the displayed frequency domain, which is (Center - Span/2) to (Center + Span/2). The width of the domain is defined using the command [SPECTrum:FREQuency:SPAN](#).

Parameters:

<CenterFrequency>

SPECTrum:FREQuency:FULLspan

Performs the spectrum analysis calculation for the full frequency span.

Usage: Event

SPECTrum:FREQuency:SPAN

The span is specified in Hertz and defines the width of the displayed frequency range, which is (Center - Span/2) to (Center + Span/2).

Parameters:

SPECTrum:FREQUENCY:START

Defines the start frequency of the displayed frequency domain at the left display edge:
Center - Span/2

You can set start and stop frequency instead of defining a center frequency and span.

Parameters:

<StartFrequency> Range: Depends on various other settings, mainly on time base, span/RBW ratio, and center frequency.

SPECTrum:FREQUENCY:STOP

Defines the stop frequency of the displayed frequency domain at the right display edge:
Center + Span/2

You can set start and stop frequency instead of defining a center frequency and span.

Parameters:

<StopFrequency> Range: Depends on various other settings, mainly on time base, span/RBW ratio, and center frequency.

SPECTrum:FREQUENCY:BANDwidth[:RESolution][:VALue] <ResolutionBandwidth>

Defines the resolution bandwidth - the minimum frequency step at which the individual components of a spectrum can be distinguished.

Parameters:

<ResolutionBandwidthRange> Depends on various other settings.

SPECTrum:FREQUENCY:BANDwidth[:RESolution]:RATio <SpanRBWratio>

Defines the ratio of span (Hz) / resolution bandwidth (Hz). The span/RBW ratio is half the number of points used for FFT which is defined with manual operation in the menu.

Parameters:

<SpanRBWratio> Range: The value is changed in 2^n steps from 2^{10} to 2^{15} (1024, 2048, 4096, 8192, 16384, 32768).

15.8.3.3 Time Settings

SPECTrum:TIME:POSition.....	376
SPECTrum:TIME:RANGe.....	377

SPECTrum:TIME:POSition <TimePosition>

Sets the time position of the analyzed time range.

Parameters:

<TimePosition>

SPECTrum:TIME:RANGe <TimeRange>

Sets the time range for the time domain diagram.

Parameters:

<TimeRange>

15.8.3.4 Waveform Settings

SPECTrum:WAVeform:AVERage[:ENABle].....	377
SPECTrum:WAVeform:MAXimum[:ENABle].....	377
SPECTrum:WAVeform:MINimum[:ENABle].....	377
SPECTrum:WAVeform:SPECTrum[:ENABle].....	377
SPECTrum:FREQuency:AVERage:COUNT.....	377
SPECTrum:FREQuency:AVERage:COMPLete?.....	377
SPECTrum:FREQuency:RESet.....	377

SPECTrum:WAVeform:AVERage[:ENABle] <WaveformEnable>**SPECTrum:WAVeform:MAXimum[:ENABle]** <WaveformEnable>**SPECTrum:WAVeform:MINimum[:ENABle]** <WaveformEnable>**SPECTrum:WAVeform:SPECTrum[:ENABle]** <WaveformEnable>

Enables/disables the indicated waveform.

Parameters:

<WaveformEnable> ON | OFF

*RST: ON

SPECTrum:FREQuency:AVERage:COUNT <AverageCount>

Defines the number of spectrums used for averaging.

Parameters:

<AverageCount>

SPECTrum:FREQuency:AVERage:COMPLete?

Returns the state of spectrum averaging.

Parameters:

<AverageComplete>

Usage: Query only

SPECTrum:FREQuency:RESet

Resets the Min Hold, Max Hold, Spectrum and Average waveforms to the current waveform.

Usage: Event

15.8.3.5 Waveform Data

SPECTrum:WAVeform:AVERage:DATA?	378
SPECTrum:WAVeform:MAXimum:DATA?	378
SPECTrum:WAVeform:MINimum:DATA?	378
SPECTrum:WAVeform:SPECTrum:DATA?	378
SPECTrum:WAVeform:AVERage:DATA:HEADer?	378
SPECTrum:WAVeform:MAXimum:DATA:HEADer?	378
SPECTrum:WAVeform:MINimum:DATA:HEADer?	379
SPECTrum:WAVeform:SPECTrum:DATA:HEADer?	379
SPECTrum:WAVeform:AVERage:DATA:POINts?	379
SPECTrum:WAVeform:MAXimum:DATA:POINts?	379
SPECTrum:WAVeform:MINimum:DATA:POINts?	379
SPECTrum:WAVeform:SPECTrum:DATA:POINts?	379
SPECTrum:WAVeform:AVERage:DATA:XINCrement?	379
SPECTrum:WAVeform:MAXimum:DATA:XINCrement?	379
SPECTrum:WAVeform:MINimum:DATA:XINCrement?	379
SPECTrum:WAVeform:SPECTrum:DATA:XINCrement?	379
SPECTrum:WAVeform:AVERage:DATA:XORigin?	379
SPECTrum:WAVeform:MAXimum:DATA:XORigin?	379
SPECTrum:WAVeform:MINimum:DATA:XORigin?	379
SPECTrum:WAVeform:SPECTrum:DATA:XORigin?	379
SPECTrum:WAVeform:AVERage:DATA:YINCrement?	379
SPECTrum:WAVeform:MAXimum:DATA:YINCrement?	379
SPECTrum:WAVeform:MINimum:DATA:YINCrement?	379
SPECTrum:WAVeform:SPECTrum:DATA:YINCrement?	379
SPECTrum:WAVeform:AVERage:DATA:YORigin?	380
SPECTrum:WAVeform:MAXimum:DATA:YORigin?	380
SPECTrum:WAVeform:MINimum:DATA:YORigin?	380
SPECTrum:WAVeform:SPECTrum:DATA:YORigin?	380
SPECTrum:WAVeform:AVERage:DATA:YRESolution?	380
SPECTrum:WAVeform:MAXimum:DATA:YRESolution?	380
SPECTrum:WAVeform:MINimum:DATA:YRESolution?	380
SPECTrum:WAVeform:SPECTrum:DATA:YRESolution?	380

SPECTrum:WAVeform:AVERage:DATA?

SPECTrum:WAVeform:MAXimum:DATA?

SPECTrum:WAVeform:MINimum:DATA?

SPECTrum:WAVeform:SPECTrum:DATA?

Returns the data of the indicated waveform points for transmission from the instrument to the controlling computer. The waveform data can be used in MATLAB, for example.

Return values:

<Data> List of values

Usage: Query only

SPECTrum:WAVeform:AVERage:DATA:HEADer?

SPECTrum:WAVeform:MAXimum:DATA:HEADer?

SPECTrum:WAVeform:MINimum:DATA:HEADer?
SPECTrum:WAVeform:SPECTrum:DATA:HEADer?

Returns information on the indicated waveform.

Return values:

<Header> StringData

Usage: Query only

SPECTrum:WAVeform:AVERage:DATA:POINts?
SPECTrum:WAVeform:MAXimum:DATA:POINts?
SPECTrum:WAVeform:MINimum:DATA:POINts?
SPECTrum:WAVeform:SPECTrum:DATA:POINts?

Returns the number of data samples that are returned with
 SPECTrum:WAVeform:xxx:DATA for the indicated waveform.

Return values:

<DataPoints>

Usage: Query only

SPECTrum:WAVeform:AVERage:DATA:XINCrement?
SPECTrum:WAVeform:MAXimum:DATA:XINCrement?
SPECTrum:WAVeform:MINimum:DATA:XINCrement?
SPECTrum:WAVeform:SPECTrum:DATA:XINCrement?

Return the level difference between two adjacent samples of the indicated waveform.

Return values:

<Xincrement>

Usage: Query only

SPECTrum:WAVeform:AVERage:DATA:XORigin?
SPECTrum:WAVeform:MAXimum:DATA:XORigin?
SPECTrum:WAVeform:MINimum:DATA:XORigin?
SPECTrum:WAVeform:SPECTrum:DATA:XORigin?

Returns the frequency of the first sample of the indicated waveform.

Return values:

<Xorigin>

Usage: Query only

SPECTrum:WAVeform:AVERage:DATA:YINCrement?
SPECTrum:WAVeform:MAXimum:DATA:YINCrement?
SPECTrum:WAVeform:MINimum:DATA:YINCrement?
SPECTrum:WAVeform:SPECTrum:DATA:YINCrement?

Returns the voltage value per bit of the indicated waveform.

Return values:

<Yincrement>

Usage: Query only**SPECTrum:WAVeform:AVERage:DATA:YORigin?****SPECTrum:WAVeform:MAXimum:DATA:YORigin?****SPECTrum:WAVeform:MINimum:DATA:YORigin?****SPECTrum:WAVeform:SPECTrum:DATA:YORigin?**

Returns the vertical bit resolution of the indicated waveform.

Return values:

<Yorigin>

Usage: Query only**SPECTrum:WAVeform:AVERage:DATA:YRESolution?****SPECTrum:WAVeform:MAXimum:DATA:YRESolution?****SPECTrum:WAVeform:MINimum:DATA:YRESolution?****SPECTrum:WAVeform:SPECTrum:DATA:YRESolution?**

Returns the vertical bit resolution of the indicated waveform.

Return values:

<Yresolution>

Usage: Query only**15.8.4 Spectrum Analysis (Option R&S RTB-K18)**

- [Spectrogram](#).....380
- [Peak List Settings](#)..... 381
- [Reference Marker](#)..... 383
- [Peak List Results](#)..... 385
- [Display Settings for Spectrum and Spectrogram](#)..... 387

15.8.4.1 Spectrogram**SPECTrum:SPECTrogram:RESet**

Resets the current spectrogram and starts a new recording of information.

Usage: Event**SPECTrum:SPECTrogram:SCALe <LinesPerAcquisition>**

Defines a zoom factor for the spectrogram.

Parameters:

<LinesPerAcquisition>Range: 1 to 20
 Increment: 1
 *RST: 1

DISPlay:CBAR:SPECTrogram[:POSition] <DividerPosition>

Defines the position of the divide bar on top of the spectrogram.

Parameters:

<DividerPosition> Vertical position in pixel, measured from the top edge. The vertical display size is 800 px.
 Default unit: px

15.8.4.2 Peak List Settings

SPECTrum:MARKer:RTABLE:ENABLE.....	381
SPECTrum:MARKer[:ENABLE].....	381
SPECTrum:MARKer:SOURce.....	381
SPECTrum:MARKer:SETup:MMODE.....	382
SPECTrum:MARKer:SETup:MLEVel.....	382
SPECTrum:MARKer:SETup:DISTance.....	382
SPECTrum:MARKer:SETup:EXCURsion.....	382
SPECTrum:MARKer:SETup:MWIDth.....	382
SPECTrum:MARKer:REFerence:SETup:CMPeak.....	382
SPECTrum:MARKer:REFerence:SETup:CSCReen.....	383

SPECTrum:MARKer:RTABLE:ENABLE <ResultTable>

Shows the peak list.

Parameters:

<ResultTable> ON | OFF
 *RST: OFF

SPECTrum:MARKer[:ENABLE]

Enables the usage of markers.

Parameters:

<MarkerEnable> ON | OFF

SPECTrum:MARKer:SOURce

Defines the waveform type that is searched for peaks.

Parameters:

<Source> SPECTrum | MINHold | MAXHold | AVERAge
 *RST: SPEC

SPECTrum:MARKer:SETup:MMODE

Sets the mode for peak detection.

Parameters:

<MarkerMode> LONLy | ADVanced

LONLy

Level only: detects a peak when a certain minimum level is exceeded. You can define the minimum level with [SPECTrum:MARKer:SETup:MLEVEL](#).

ADVanced

Enables a more precise advanced peak definition.

SPECTrum:MARKer:SETup:MLEVEL

Sets the minimum level for marker peak detection.

Parameters:

<MinimumLevel>

SPECTrum:MARKer:SETup:DISTance

Sets a distance between two subsequent peaks that has to be kept, for the peak to be detected.

Parameters:

<Distance>

SPECTrum:MARKer:SETup:EXCursion

Sets a level difference between two subsequent peaks that has to be kept, for the peak to be detected.

Parameters:

<Excursion>

SPECTrum:MARKer:SETup:MWIDth

Sets the maximum width, that a peak can have for it to be detected.

Parameters:

<MaximumWidth>

SPECTrum:MARKer:REFerence:SETup:CMPeak

Centers the display to the highest detected peak.

Usage: Event

SPECTrum:MARKer:REFerence:SETup:CSCReen

Centers the display to the center frequency.

Usage: Event

15.8.4.3 Reference Marker

SPECTrum:MARKer:REFerence:SETup:MODE.....	383
SPECTrum:MARKer:REFerence:SETup:INDex.....	383
SPECTrum:MARKer:REFerence:SETup:FREQUency.....	383
SPECTrum:MARKer:REFerence:SETup:SPAN.....	383
SPECTrum:MARKer:RMARker?.....	384
SPECTrum:MARKer:RMARker:FREQUency?.....	384
SPECTrum:MARKer:RMARker:LEVel?.....	384
SPECTrum:MARKer:RMODE.....	384

SPECTrum:MARKer:REFerence:SETup:MODE

Sets the mode for the selection of the reference peak.

Parameters:

<ReferenceMode> OFF | INDicated | RANGE

The reference marker is set to the peak with a specified index number.

RANGE

The peak with the highest level within the selected range is set as the reference marker.

SPECTrum:MARKer:REFerence:SETup:INDex

Sets the reference marker to the peak with the specified index, if `SPECTrum:MARKer:REFerence:SETup:MODE` is set to INDicated.

Parameters:

<ReferenceIndex>

SPECTrum:MARKer:REFerence:SETup:FREQUency

Sets the center frequency for the capture range, if `SPECTrum:MARKer:REFerence:SETup:MODE` is set to RANGE.

Parameters:

<ReferenceFrequency>

SPECTrum:MARKer:REFerence:SETup:SPAN

Sets the span range, the ratio of the capture range and the width of the specified reference mode, if `SPECTrum:MARKer:REFerence:SETup:MODE` is set to RANGE.

Parameters:

<ReferenceSpan>

SPECTrum:MARKer:RMARker?

Returns the frequency and the level values of the present reference marker.

Return values:

<ReferenceFrequency>

<ReferenceLevel>

Usage: Query only

SPECTrum:MARKer:RMARker:FREQuency?

Returns the frequency of the reference marker.

Return values:

<ReferenceFrequency>

Usage: Query only

SPECTrum:MARKer:RMARker:LEVel?

Returns the level of the reference marker.

Return values:

<ReferenceLevel>

Usage: Query only

SPECTrum:MARKer:RMODe <ResultMode>

Defines the values that are shown in the peak list. You can use absolute values, or delta values in comparison to the reference marker.

Parameters:

<ResultMode> ABSolute | FREQuency | LEVel | FLEVel

ABSolute

Frequency and magnitude in absolute values.

FREQuency

Frequency relative to the reference marker frequency, magnitude in absolute values.

LEVel

Frequency in absolute values, magnitude relative to the level of the reference marker.

FLEVel

Frequency and magnitude relative to the reference marker values.

15.8.4.4 Peak List Results

SPECTrum:MARKer:RCOunt?.....	385
SPECTrum:MARKer:RESult<n>?.....	385
SPECTrum:MARKer:RESult<n>:ALL?.....	385
SPECTrum:MARKer:RESult<n>:ALL:DELTA?.....	385
SPECTrum:MARKer:RESult<n>:DELTA?.....	386
SPECTrum:MARKer:RESult<n>:FREQuency?.....	386
SPECTrum:MARKer:RESult<n>:FREQuency:DELTA?.....	386
SPECTrum:MARKer:RESult<n>:LEVel?.....	386
SPECTrum:MARKer:RESult<n>:LEVel:DELTA?.....	387

SPECTrum:MARKer:RCOunt?

Returns the number of detected peaks.

Parameters:

<ResultCount>

Usage: Query only

SPECTrum:MARKer:RESult<n>?

Returns the frequency and level values of the n-th marker.

Suffix:

<n> *

Return values:

<ResultFrequency>

<ResultLevel>

Usage: Query only

SPECTrum:MARKer:RESult<n>:ALL?

Returns a list of all marker with the corresponding frequency and level values.

Suffix:

<n> *

Return values:

<ResultValues> List of numeric values with shape <freq>,<level>,...

Usage: Query only

SPECTrum:MARKer:RESult<n>:ALL:DELTA?

Returns the delta frequency and delta level, the difference between the frequency/level of the specified marker and the frequency/level of the reference marker.

Suffix:

<n> *

Return values:

<ResultValues> List of numeric values with shape <freq>,<level>,...

Usage:

Query only

SPECTrum:MARKer:RESult<n>:DELTA?

Returns the difference in the values between the n-th marker and the reference marker.

Suffix:

<n> *

Usage:

Query only

SPECTrum:MARKer:RESult<n>:FREQuency?

Returns the frequency of the n-th marker.

Suffix:

<n> *

Return values:

<ResultFrequency>

Usage:

Query only

SPECTrum:MARKer:RESult<n>:FREQuency:DELTA?

Returns the delta frequency, the difference between the frequency of the specified marker and the level of the reference marker.

Suffix:

<n> *

Return values:

<ResultFrequencyDifference>

Usage:

Query only

SPECTrum:MARKer:RESult<n>:LEVel?

Returns the level of the n-th marker.

Suffix:

<n> *

Return values:

<ResultLevel>

Usage:

Query only

SPECTrum:MARKer:RESult<n>:LEVel:DELTA?

Returns the delta level, the difference between the level of the specified marker and the level of the reference marker.

Suffix:

<n> *

Return values:

<ResultLevelDifference>

Usage: Query only

15.8.4.5 Display Settings for Spectrum and Spectrogram

SPECTrum:FREQuency:BANDwidth[:RESolution]:AUTO.....	387
SPECTrum:DIAGram:COLor:MAGNitude:MODE.....	387
SPECTrum:DIAGram:COLor:MAXimum[:LEVel].....	387
SPECTrum:DIAGram:COLor:MINimum[:LEVel].....	388
SPECTrum:DIAGram:COLor:SCHEME:FDMain.....	388
SPECTrum:DIAGram:COLor:SCHEME:SPECTrogram.....	388
SPECTrum:DIAGram:SPECTrogram[:ENABLE].....	388

SPECTrum:FREQuency:BANDwidth[:RESolution]:AUTO <AutoSpanRBWratio>

Enables the auto resolution bandwidth mode. In the auto mode "Span": "RBW" ratio of ~1:100 is set.

Parameters:

<AutoSpanRBWratio> ON | OFF

*RST: ON

SPECTrum:DIAGram:COLor:MAGNitude:MODE <MagnitudeMode>

Enables the magnitude coloring of the waveform.

Parameters:

<MagnitudeMode> ON | OFF

SPECTrum:DIAGram:COLor:MAXimum[:LEVel] <MaximumLevel>

Sets the level used as a maximum of the color scale selected with [SPECTrum:DIAGram:COLor:SCHEME:SPECTrogram/SPECTrum:DIAGram:COLor:SCHEME:FDMain](#).

All level values lower than the minimum are displayed with the minimum color.

Parameters:

<MaximumLevel>

SPECTrum:DIAGram:COLor:MINimum[:LEVel] <MinimumLevel>

Sets the level used as a minimum of the color scale selected with [SPECTrum:DIAGram:COLor:SCHeM:e:SPECTrogram/SPECTrum:DIAGram:COLor:SCHeM:e:FDOMain](#).

All level values lower than the minimum are displayed with the minimum color.

Parameters:

<MinimumLevel>

SPECTrum:DIAGram:COLor:SCHeM:e:FDOMain <ColorScheme>

Sets the color scale for the display of the waveform in the frequency domain diagram.

Parameters:

<ColorScheme> MONochrome | TEMPerature | RAINbow

SPECTrum:DIAGram:COLor:SCHeM:e:SPECTrogram <ColorScheme>

Sets the color scale for the display of the spectrogram.

Parameters:

<ColorScheme> MONochrome | TEMPerature | RAINbow

SPECTrum:DIAGram:SPECTrogram[:ENABle] <Enable>

Enables the display of the spectrum diagram.

Parameters:

<Enable> ON | OFF

15.8.5 XY-Waveforms

DISPlay:MODE	388
DISPlay:XY:XSource	389
DISPlay:XY:Y1Source	389
DISPlay:XY:Y2Source	389

DISPlay:MODE <Mode>

Sets the diagram mode.

Parameters:

<Mode> YT | XY

YT

Default time diagram with a time axis in x-direction and the signal amplitudes displayed in y-direction.

XY

XY-diagram, combines the voltage levels of two waveforms in one diagram.

*RST: YT

DISPlay:XY:XSource <Source>

Defines the source to be displayed in x-direction in an XY-diagram, replacing the usual time base.

Parameters:

<Source> CH1 | CH2 | CH3 | CH4

CH3 and CH4 are only available with 4-channel R&S RTB2000 oscilloscopes.

*RST: CH1

DISPlay:XY:Y1Source <Source>

Defines the first source to be displayed in y-direction in an XY-diagram.

Parameters:

<Source> CH1 | CH2 | CH3 | CH4

CH3 and CH4 are only available with 4-channel R&S RTB2000 oscilloscopes.

*RST: CH2

DISPlay:XY:Y2Source <Source>

Defines an optional second source to be displayed in y-direction in an XY-diagram. The command is only relevant for 4-channel R&S RTB2000 instruments.

Parameters:

<Source> NONE | CH1 | CH2 | CH3 | CH4

*RST: NONE

15.8.6 Digital Voltmeter

The DVM suffix <m> sets the number of the DVM measurement (measurement place).

DVM<m>:ENABle	389
DVM<m>:SOURce	390
DVM<m>:TYPE	390
DVM<m>:RESult[:ACTual]?	390
DVM<m>:RESult[:ACTual]:STATus?	391

DVM<m>:ENABle <VoltmeterEnable>

Enables and disables all configured meter measurements.

Suffix:

<m> 1..4
The suffix is irrelevant.

Parameters:

<VoltmeterEnable> ON | OFF
*RST: OFF

DVM<m>:SOURCE <Source>

Selects an analog channel as the source of the selected meter measurement.

Suffix:

<m> 1..4
Sets the number of the meter measurement.

Parameters:

<Source> CH1 | CH2 | CH3 | CH4
CH3 and CH4 are only available with 4-channel instruments.

DVM<m>:TYPE <MeasurementType>

Sets the measurement type for the indicated DVM measurement.

Set *OFF* to disable the measurement.

Suffix:

<m> 1..4
Sets the number of the meter measurement.

Parameters:

<MeasurementType> DC | ACDCrms | ACRMs | OFF
DC: mean value of the signal
ACDCrms: RMS value of the signal (AC+DC RMS)
ACRMs: RMS value of the signal's AC component (AC RMS)
OFF: disables the selected meter measurement.
*RST: OFF

DVM<m>:RESult[:ACTual]?

Returns the current value of the selected meter measurement.

Suffix:

<m> 1..4
Sets the number of the meter measurement.

Example: DVM2:SOUR CH2
 DVM2:TYPE DCRMs
 DVM2:RES?
 <-- 7.089E-01
 An RMS measurement is performed on measurement place 2, on channel 2. The result is 708.9 mV.

Usage: Query only

DVM<m>:RESult[:ACTual]:STATus?

Returns the result value and the status of the result.

The status is the decimal representation of a 4-bit register value:

- Bit 0 = 1: result is valid
- Bit 1 = 1: no result available
- Bit 2 = 1: clipping occurs
- Bit 3 = 1: no period found

Suffix:

<m> 1..4
 Sets the number of the meter measurement.

Return values:

<CurrentValue> Measured value
 <Status> Decimal status value

Example:

```
DVM:SOUR CH1
DVM:TYPE MEAN
DVM:RES:STAT?
<-- 4.968E-01,5
```

The result value of the mean measurement on channel 1 is 496.1 mV. The result status is 5 (decimal) = 0101 (binary). That means, the result is valid (bit 0 = 1), and the signal is clipped by the limits of the ADC range (bit 3 = 1).

Usage: Query only

15.8.7 Trigger Counter

TCOUNTER:ENABLE.....	391
TCOUNTER:SOURce.....	392
TCOUNTER:RESult[:ACTual]:FREQuency?.....	392
TCOUNTER:RESult[:ACTual]:PERiod?.....	392

TCOUNTER:ENABLE <Enable>

Enables or disables the trigger counter measurements.

Parameters:

<Enable> ON | OFF

TCOUNTER:SOURce

Sets the measurement source for the counter.

Parameters:

<CounterSource> CH1 | CH2 | CH3 | CH4 | TRIGger
 TRIGger: Trigger source
 *RST: TRIG

TCOUNTER:RESult[:ACTual]:FREQuency?

Returns the frequency of the trigger source.

Return values:

<FrequencyValue> Default unit: Hz

Usage: Query only**TCOUNTER:RESult[:ACTual]:PERiod?**

Returns the period of the trigger source.

Return values:

<PeriodValue> Default unit: s

Usage: Query only

15.8.8 Bode Plot (Option R&S RTB-K36)

15.8.8.1 Bode Plot Setup

BPLot:ENABle.....	393
BPLot:AMPLitude:PROFile:COUNT.....	393
BPLot:AMPLitude:PROFile:POINT<n>:AMPLitude.....	393
BPLot:AMPLitude:PROFile:POINT<n>:FREQuency.....	393
BPLot:AMPLitude:MODE.....	393
BPLot:FREQuency:DATA?.....	394
BPLot:FREQuency:STARt.....	394
BPLot:FREQuency:STOP.....	394
BPLot:INPut[:SOURce].....	394
BPLot:MEASurement:DELay.....	394
BPLot:MEASurement:POINT[:DISPLAY].....	394
BPLot:OUTPut[:SOURce].....	395
BPLot:POINts:LOGarithmic.....	395

BPLot:REPeat.....	395
BPLot:RESet.....	395
BPLot:STAtE.....	395

BPLot:ENABle

Enables the Bode plot diagram.

Parameters:

<PlotEnable> ON | OFF
 *RST: OFF

BPLot:AMPLitude:PROFile:COUNT

Sets the number of different points that you can define for the amplitude profile.

Parameters:

<NumberOfPoints> Range: 2 to 16
 Increment: 1
 *RST: 4

BPLot:AMPLitude:PROFile:POINT<n>:AMPLitude

Sets the amplitude of the specified point of the amplitude profile.

Parameters:

<AmplitudeMode>

BPLot:AMPLitude:PROFile:POINT<n>:FREQuency

Sets the frequency of the specified point of the amplitude profile.

Parameters:

<Frequency>

BPLot:AMPLitude:MODE

Sets the amplitude mode.

Parameters:

<AmplitudeMode> CONStant | PROFil

CONStant

In the amplitude constant mode, there is a fixed amplitude for all frequencies.

PROFil

In the amplitude profile mode, you can define different amplitudes for different frequency.

*RST: CONS

BPLot:FREQUENCY:DATA?

Returns the data of the frequency waveform.

Parameters:

<FrequencyData>

Usage: Query only

BPLot:FREQUENCY:START

Sets the start frequency of the sweep for the Bode plot.

Parameters:

<StartFrequency> Range: 10 to 25e6
 Increment: 1
 *RST: 100

BPLot:FREQUENCY:STOP

Sets the stop frequency of the sweep for the Bode plot.

Parameters:

<StopFrequency> Range: 10 to 25e6
 Increment: 1
 *RST: 1e6

BPLot:INPut[:SOURce]

Selects the channel for the input signal of the DUT.

Parameters:

<InputSource> CH1 | CH2 | CH3 | CH4
 *RST: CH1

BPLot:MEASurement:DELay

Sets a time delay, that the system waits before measuring the next point of the bode plot.

Parameters:

<MeasDelay> Range: 0 to 10.0
 Increment: 0.01
 *RST: 0

BPLot:MEASurement:POINT[:DISPLAY]

Enables the display of the measurement points in the bode plot.

Parameters:

<PointDisplay> ON | OFF

BPLot:OUTPut[:SOURce]

Selects the channel for the output signal of the DUT.

Parameters:

<OutputSource> CH1 | CH2 | CH3 | CH4
*RST: CH2

BPLot:POINts:LOGarithmic

Sets the number of points per decade that are measured.

Parameters:

<PointsPerDecade> Range: 10 to 500
Increment: 1
*RST: 10

BPLot:REPeat

Repeats the measurement, using the same parameters.

Parameters:

<RepeatedMeasurement> ON | OFF
*RST: OFF

BPLot:RESet

Deletes all test results.

Usage: Event

BPLot:STATe

Starts the Bode plot measurement.

Parameters:

<PlotState> RUN | STOP
*RST: STOP

15.8.8.2 Bode Plot Diagram Settings

BPLot:GAIN:DATA?	396
BPLot:GAIN:ENABLE	396
BPLot:GAIN:POSition	396
BPLot:GAIN:SCALe	396
BPLot:PHASe:DATA?	396
BPLot:PHASe:ENABLE?	396
BPLot:PHASe:POSition?	397
BPLot:PHASe:SCALe?	397

BPLot:AMPLitude:ENABLE.....	397
BPLot:AMPLitude:POSition.....	397
BPLot:AMPLitude:SCALe.....	397

BPLot:GAIN:DATA?

Returns the data of the gain waveform.

Parameters:

<GainData>

Usage: Query only

BPLot:GAIN:ENABLE

Enables the gain waveform for the Bode plot.

Parameters:

<Enable> ON | OFF
 *RST: ON

BPLot:GAIN:POSition

Sets the vertical position of the gain waveform in divisions.

Parameters:

<WaveformPosition> Range: -20.0 to 20.0
 Increment: 0.1
 *RST: 3.0

BPLot:GAIN:SCALe

Sets the vertical scale for the gain waveform.

Parameters:

<WaveformScale> Range: 0.1 to 20.0
 Increment: 0.1
 *RST: 20.0

BPLot:PHASe:DATA?

Returns the data of the phase waveform.

Parameters:

<PhaseData>

Usage: Query only

BPLot:PHASe:ENABLE?

Enables the phase waveform for the Bode plot.

Parameters:

<Enable> ON | OFF
 *RST: ON

Usage: Query only

BPLot:PHASe:POSition?

Sets the vertical position of the phase waveform in divisions.

Parameters:

<WaveformPosition> Range: -20.0 to 20.0
 Increment: 0.1
 *RST: 0.0

Usage: Query only

BPLot:PHASe:SCALe?

Sets the vertical scale for the phase waveform.

Parameters:

<WaveformScale> Range: 0.1 to 45.0
 Increment: 0.1
 *RST: 45.0

Usage: Query only

BPLot:AMPLitude:ENABLE

Enables the amplitude waveform for the Bode plot.

Parameters:

<Enable> ON | OFF
 *RST: OFF

BPLot:AMPLitude:POSition

Sets the vertical position of the amplitude waveform in divisions.

Parameters:

<WaveformPosition> Range: -10.0 to 10.0
 Increment: 0.1
 *RST: -5.0

BPLot:AMPLitude:SCALe

Sets the vertical scale for the amplitude waveform.

Parameters:

<WaveformScale> Range: 0.1 to 2.0
 Increment: 0.001
 *RST: 1.0

15.8.8.3 Marker Table

BPLot:MARKer<m>:DIFFerence:FREQ?	398
BPLot:MARKer<m>:DIFFerence:GAIN?	398
BPLot:MARKer<m>:DIFFerence:PHASe?	398
BPLot:MARKer<m>:FREQuency	399
BPLot:MARKer<m>:GAIN?	399
BPLot:MARKer<m>:INDex	399
BPLot:MARKer<m>:PHASe?	399
BPLot:MARKer<m>:SSCReen	399

BPLot:MARKer<m>:DIFFerence:FREQ?

Returns the delta value of the frequency between the two markers.

Suffix:

<m> 1..2
 The suffix is irrelevant.

Parameters:

<FrequencyDifference>

Usage: Query only

BPLot:MARKer<m>:DIFFerence:GAIN?

Returns the delta value of the gain between the two markers.

Suffix:

<m> 1..2
 The suffix is irrelevant.

Parameters:

<GainDifference>

Usage: Query only

BPLot:MARKer<m>:DIFFerence:PHASe?

Returns the delta value of the phase between the two markers.

Suffix:

<m> 1..2
 The suffix is irrelevant.

Parameters:

<PhaseDifference>

Usage: Query only

BPLot:MARKer<m>:FREQuency

Returns the frequency for the specified marker.

Suffix:

<m> 1..2

Parameters:

<MarkerFrequency>

BPLot:MARKer<m>:GAIN?

Returns the gain for the specified marker.

Suffix:

<m> 1..2
Selects the marker number.

Parameters:

<PhaseValue>

Usage: Query only

BPLot:MARKer<m>:INDex

Returns the index for the specified marker.

Suffix:

<m> 1..2
Selects the marker number.

Parameters:

<Index>

BPLot:MARKer<m>:PHASe?

Returns the phase value for the specified marker.

Suffix:

<m> 1..2
Selects the marker number.

Parameters:

<GainValue>

Usage: Query only

BPLot:MARKer<m>:SSCReen

Resets the marker to their initial positions. This is helpful if the markers have disappeared from the display or need to be moved for a larger distance.

Suffix:	
<m>	1..2
Usage:	Event

15.9 Documenting Results

This chapter describes commands on how to transfer data from the instrument to a computer, how to export data to file, how to print and save screenshots, and how to manage measurement settings.

- [Transfer of Waveform Data](#)..... 400
- [Waveform Data Export to File](#)..... 412
- [Screenshots](#)..... 413
- [Instrument Settings: Mass MEMemory Subsystem](#)..... 414

15.9.1 Transfer of Waveform Data

This chapter describes data transfer commands that have effect on other commands in different applications of the instrument, and transfer commands that work in the same way.

15.9.1.1 Format Settings

- [FORMat\[:DATA\]](#)..... 400
- [FORMat:BORDER](#)..... 402

FORMat[:DATA] <DataFormat>,<Accuracy>

Defines the format for data export with

- [CHANnel<m>:DATA?](#) on page 402
- [CHANnel<m>:DATA:ENvelope?](#) on page 404
- [CALCulate:MATH<m>:DATA?](#) on page 406
- [REFCurve<m>:DATA?](#) on page 407

Parameters:

<DataFormat> ASCii | REAL | UINTEger

ASCii

List of values, for example, 1.23,1.22,1.24,.. File format for waveform export is TXT.

<Accuracy> is 0 which means that the instrument selects the number of digits to be returned. The query returns ASC,0.

REAL

Binary format. <Accuracy> is 32. The query returns REAL,32.

File format for waveform export is FLT.

The data is stored as binary data (Definite Length Block Data according to IEEE 488.2). Each waveform value is formatted in 32 Bit IEEE 754 Floating-Point-Format.

The schema of the result string is as follows:

#41024<value1><value2>...<value n> with:

#4 = number of digits of the following number (= 4 in the example)

1024 = number of following data bytes (= 1024 in the example)

<value> = 4-byte floating point values

UINTeger

Unsigned integer format, binary values with length 8 bit (1 byte per sample), 16 bit (2 bytes per sample) or 32 bit (4 bytes per sample): UINT, 8 or UINT, 16 or UINT, 32. File format for waveform export is BIN.

The data range for UINT, 8 is 0 to 255, the data range for

UINT, 16 is 0 to 65.535 and for UINT, 32 is $2^{32} - 1$.

The schema of the result string is the same as for REAL format.

For data conversion, you need the results of following commands:

...:DATA:XORigin?; ...:DATA:XINcrement?; ...:DATA:Yorigin?; ...:DATA:YINcrement?; ...:DATA:

YRESolution?. They are described below in this chapter. The way of data conversion is described in [Chapter 15.2.1.4, "Reading Waveform Data in Unsigned Integer Format"](#), on page 282.

32 bit data is relevant for average waveforms if averaging 512 or 1024 waveforms. The resulting data is 17 bits long (512 waveforms) or 18 bit (1024 waveforms).

CSV

Only for waveform export in CSV files. List of comma-separated values, for example, 1.23,1.22,1.24,..

<Accuracy> is 0 which means that the instrument selects the number of digits to be returned. The query returns CSV,0.

*RST: ASC

<Accuracy> 0 | 8 | 16 | 32

Length of a data value in bit

0 - for ASC only

32 - for REAL

8 | 16 | 32 - for UINT

*RST: 0

Example: Set the ASCII data format:

FORM ASC

Example: Query for data format:

FORM?

-> ASC,0

Example: Set the unsigned integer format, 16 bit data length:
FORM UINT, 16

FORMat:BORDER <ByteOrder>

Defines the byte order for binary data export if FORMat [: DATA] is set to REAL or UINT, 16 | 32.

Parameters:

<ByteOrder> MSBFirst | LSBFirst

MSBFirst

Big endian, most significant byte first

LSBFirst

Little endian, least significant byte first

*RST: MSBF

Example: [Reading Waveform Data in Real Format](#)

ByteOrder	8 bit	16 bit	32 bit
MSBF	0xab	0xAB CD	0xAB CD 00 00
LSBF	not relevant	0xCD AB	0x00 00 CD AB

15.9.1.2 Analog Channels

CHANnel<m>:DATA?.....	402
CHANnel<m>:DATA:HEADer?.....	403
CHANnel<m>:DATA:POINts.....	403
CHANnel<m>:DATA:ENVELOpe?.....	404
CHANnel<m>:DATA:ENVELOpe:HEADer?.....	405

CHANnel<m>:DATA?

Returns the data of the analog channel waveform for transmission from the instrument to the controlling computer. The waveforms data can be used in MATLAB, for example.

To set the export format, use FORMat [: DATA] on page 400.

To set the range of samples to be returned, use CHANnel<m>:DATA:POINts.

For envelope waveforms, use the CHANnel<m>:DATA:ENVELOpe? command.

Suffix:

<m> 1..4

Selects the input channel. The number of channels depends on the instrument.

Return values:

<Data> List of values according to the format settings - the voltages of recorded waveform samples.

Example: FORM ASC
 CHAN1:DATA?
 -0.125000,-0.123016,-0.123016,-0.123016,
 -0.123016,-0.123016,...

Example: See [Chapter 15.2.1.3, "Reading Waveform Data in Real Format"](#), on page 282 and [Chapter 15.2.1.4, "Reading Waveform Data in Unsigned Integer Format"](#), on page 282

Usage: Query only

CHANnel<m>:DATA:HEADer?

Returns information on the channel waveform. For envelope waveforms, use the [CHANnel<m>:DATA:ENVELOpe:HEADer?](#) command.

Table 15-1: Header data

Position	Meaning	Example
1	XStart in s	-9.477E-008 = -94,77 ns
2	XStop in s	9.477E-008 = 94,77 ns
3	Record length of the waveform in Samples	120000
4	Number of values per sample interval, usually 1.	1

Suffix:

<m> 1..4
 Selects the input channel. The number of channels depends on the instrument.

Parameters:

<DataHeader> Comma-separated value list
 Example: -9.477E-008,9.477E-008,120000,1

Usage: Query only

CHANnel<m>:DATA:POINTs <PointSelection>

As a setting, the command selects a range of samples that will be returned with [CHANnel<m>:DATA?](#) and [CHANnel<m>:DATA:ENVELOpe?](#). As a query, it returns the number of returned samples for the selected range.

Depending on the current settings, the memory can contains more data samples than the screen is able to display. In this case, you can decide which data will be saved: samples stored in the memory or only the displayed samples.

Note: The sample range can only be changed in STOP mode. If the acquisition is running, DEF is always used automatically. If the acquisition has been stopped, data can be read from the memory, and all settings are available.

Suffix:

<m> 1..4
The command affects all channels, and the suffix is irrelevant.

Setting parameters:

<PointSelection> DEFault | MAXimum | DMAXimum
Sets the range for data queries.

DEFault

Waveform points that are visible on the screen. At maximum waveform rate, the instrument stores more samples than visible on the screen, and DEF returns less values than acquired.

MAXimum

All waveform samples that are stored in the memory. Only available if acquisition is stopped.

DMAXimum

Display maximum: Waveform samples stored in the current waveform record but only for the displayed time range. At maximum waveform rate, the instrument stores more samples than visible on the screen, and DMAX returns more values than DEF. Only available if acquisition is stopped.

*RST: DEFault

Return values:

<Points> Number of data points in the selected range.
Default unit: Samples

Example:

```
CHAN:DATA:POIN DEF
CHAN:DATA:POIN?;:CHAN2:DATA:POIN?
Returned values: 10416;10416
CHAN:DATA:POIN DMAX
CHAN:DATA:POIN?;:CHAN2:DATA:POIN?
Returned values: 124992;124992
CHAN:DATA:POIN MAX
CHAN:DATA:POIN?;:CHAN2:DATA:POIN?
Returned values: 4194302;4194302
```

Example: See [Chapter 15.2.1.3, "Reading Waveform Data in Real Format"](#), on page 282

CHANnel<m>:DATA:ENVELOpe?

Returns the data of the envelope. The envelope consists of two waveforms. The waveforms data can be used in MATLAB, for example.

Use this command only for envelope waveforms. For other channel waveforms use [CHANnel<m>:DATA?](#).

To set the export format, use [FORMat \[:DATA \]](#).

To set the range of samples to be returned, use [CHANnel<m>:DATA:POINTs](#).

Suffix:

<m> 1..4
Selects the input channel. The number of channels depends on the instrument.

Parameters:

<EnvelopeData> List of values according to the format settings - the voltages of the envelope points. The list contains two values for each sample interval.

Usage: Query only

CHANnel<m>:DATA:ENVELOpe:HEADer?

Returns information on the envelope waveform.

Use this command only for envelope waveforms. For all other channel waveforms use [CHANnel<m>:DATA:HEADer?](#).

Table 15-2: Header data

Position	Meaning	Example
1	XStart in s	-9.477E-008 = - 94,77 ns
2	XStop in s	9.477E-008 = 94,77 ns
3	Number of samples	120000
4	Number of values per sample interval. For envelope waveforms the value is 2.	2

Suffix:

<m> 1..4
Selects the input channel. The number of channels depends on the instrument.

Parameters:

<EnvelopeHeader> Comma-separated value list
Example: -9.477E-008,9.477E-008,200000,2

Usage: Query only

15.9.1.3 Math Waveforms

In addition to the commands described below, consider also the following commands:

- [CALCulate:MATH<m>:DATA:XINCrement?](#) on page 410
- [CALCulate:MATH<m>:DATA:XORigin?](#) on page 409
- [CALCulate:MATH<m>:DATA:YINCrement?](#) on page 411
- [CALCulate:MATH<m>:DATA:YORigin?](#) on page 410
- [CALCulate:MATH<m>:DATA:YRESolution?](#) on page 411

CALCulate:MATH<m>:DATA?

Returns the data of the math waveform points for transmission from the instrument to the controlling computer. The waveforms data can be used in MATHLAB, for example.

To set the export format, use [FORMat \[:DATA\]](#) on page 400.

Suffix:

<m> 1..5

Return values:

<Data> List of values according to the format settings - voltages, or magnitudes of a spectrum.

Usage: Query only

CALCulate:MATH<m>:DATA:HEADer?

Returns information on the math waveform.

Table 15-3: Header data

Position	Meaning	Example
1	XStart in s	-9.477E-008 = - 94,77 ns
2	XStop in s	9.477E-008 = 94,77 ns
3	Record length of the waveform in Samples	120000
4	Number of values per sample interval, usually 1.	1

Suffix:

<m> 1..5

Return values:

<Header> Comma-separated value list
Example: -9.477E-008, 9.477E-008, 120000, 1

Usage: Query only

CALCulate:MATH<m>:DATA:POINts?

Returns the number of data samples that are returned with [CALCulate:MATH<m>:DATA?](#).

Suffix:

<m> 1..5
Selects the math waveform.

Return values:

<DataPoints> Number of data points

Usage: Query only

15.9.1.4 Reference Waveforms

In addition to the commands described below, consider also the following commands:

- [REFCurve<m>:DATA:XINcrement?](#) on page 410
- [REFCurve<m>:DATA:XORigin?](#) on page 409
- [REFCurve<m>:DATA:YINcrement?](#) on page 411
- [REFCurve<m>:DATA:YORigin?](#) on page 410
- [REFCurve<m>:DATA:YRESolution?](#) on page 411

REFCurve<m>:DATA?

Returns the data of the reference waveform for transmission from the instrument to the controlling computer. The waveforms data can be used in MATLAB, for example.

To set the export format, use [FORMat \[:DATA\]](#) on page 400.

Suffix:

<m> 1..4
Selects the reference waveform, the internal reference storage.

Return values:

<Data> List of values according to the format settings.

Usage: Query only

REFCurve<m>:DATA:HEADer?

Returns information on the reference waveform.

Table 15-4: Header data

Position	Meaning	Example
1	XStart in s	-9.477E-008 = - 94,77 ns
2	XStop in s	9.477E-008 = 94,77 ns
3	Record length of the waveform in Samples	200000
4	Number of values per sample interval, usually 1.	1

Suffix:

<m> 1..4
Selects the reference waveform, the internal reference storage.

Parameters:

<Header> Comma-separated value list
Example: -9.477E-008, 9.477E-008, 200000, 1

Usage: Query only

15.9.1.5 Masks

In addition to the commands described below, consider also the following commands:

- [MASK:DATA:XINCrement?](#) on page 410
- [MASK:DATA:XORigin?](#) on page 409
- [MASK:DATA:YINCrement?](#) on page 411
- [MASK:DATA:YORigin?](#) on page 410
- [MASK:DATA:YRESolution?](#) on page 411

MASK:DATA?

Returns the data of the mask. The mask consists of two limit curves.

To set the export format, use [FORMat \[:DATA\]](#) on page 400.

Return values:

<Data> List of values according to the format settings - the y-values of the mask points. The list contains two values for each sample interval.

Usage: Query only

MASK:DATA:HEADer?

Returns information on the mask data that is delivered with [MASK:DATA?](#).

Table 15-5: Header data

Position	Meaning	Example
1	XStart in s	-9.477E-008 = - 94,77 ns
2	XStop in s	9.477E-008 = 94,77 ns
3	Number of samples	200000
4	Number of values per sample interval. For masks the value is 2.	2

Return values:

<DataHeader> Comma-separated value list
 Example: -9.477E-008, 9.477E-008, 200000, 2

Usage: Query only

15.9.1.6 Logic Channels

See [Chapter 15.12.1.3, "Logic Channels - Waveform Data"](#), on page 501

15.9.1.7 Parameters for Data Evaluation

To analyze waveform data, you need some parameters, which are queried using the following commands.

CHANnel<m>:DATA:XORigin?	409
CHANnel<m>:DATA:ENvelope:XORigin?	409
CALCulate:MATH<m>:DATA:XORigin?	409
MASK:DATA:XORigin?	409
LOGic<p>:DATA:XORigin?	409
DIGital<m>:DATA:XORigin?	409
REFCurve<m>:DATA:XORigin?	409
CHANnel<m>:DATA:XINCrement?	410
CHANnel<m>:DATA:ENvelope:XINCrement?	410
CALCulate:MATH<m>:DATA:XINCrement?	410
MASK:DATA:XINCrement?	410
LOGic<p>:DATA:XINCrement?	410
DIGital<m>:DATA:XINCrement?	410
REFCurve<m>:DATA:XINCrement?	410
CHANnel<m>:DATA:YORigin?	410
CHANnel<m>:DATA:ENvelope:YORigin?	410
CALCulate:MATH<m>:DATA:YORigin?	410
MASK:DATA:YORigin?	410
LOGic<p>:DATA:YORigin?	410
DIGital<m>:DATA:YORigin?	410
REFCurve<m>:DATA:YORigin?	410
CHANnel<m>:DATA:YINCrement?	411
CHANnel<m>:DATA:ENvelope:YINCrement?	411
CALCulate:MATH<m>:DATA:YINCrement?	411
MASK:DATA:YINCrement?	411
LOGic<p>:DATA:YINCrement?	411
DIGital<m>:DATA:YINCrement?	411
REFCurve<m>:DATA:YINCrement?	411
CHANnel<m>:DATA:YRESolution?	411
CHANnel<m>:DATA:ENvelope:YRESolution?	411
CALCulate:MATH<m>:DATA:YRESolution?	411
MASK:DATA:YRESolution?	411
LOGic<p>:DATA:YRESolution?	411
DIGital<m>:DATA:YRESolution?	411
REFCurve<m>:DATA:YRESolution?	411

CHANnel<m>:DATA:XORigin?
CHANnel<m>:DATA:ENvelope:XORigin?
CALCulate:MATH<m>:DATA:XORigin?
MASK:DATA:XORigin?
LOGic<p>:DATA:XORigin?
DIGital<m>:DATA:XORigin?
REFCurve<m>:DATA:XORigin?

Return the time of the first sample of the indicated waveform.

The commands are relevant for data conversion if binary data format is defined ([FORM UINT, 8 | 16 | 32](#)).

Suffix:

<m> 1..4

Return values:

<Xorigin> Time in s

Example:

See [Chapter 15.2.1.4, "Reading Waveform Data in Unsigned Integer Format"](#), on page 282

Usage:

Query only

CHANnel<m>:DATA:XINCrement?

CHANnel<m>:DATA:ENVELOpe:XINCrement?

CALCulate:MATH<m>:DATA:XINCrement?

MASK:DATA:XINCrement?

LOGic<p>:DATA:XINCrement?

DIGital<m>:DATA:XINCrement?

REFCurve<m>:DATA:XINCrement?

Return the time difference between two adjacent samples of the indicated waveform.

The commands are relevant for data conversion if binary data format is defined ([FORM UINT, 8 | 16 | 32](#)).

Suffix:

<m> 1..4

Return values:

<Xincrement> Time in s

Example:

See [Chapter 15.2.1.4, "Reading Waveform Data in Unsigned Integer Format"](#), on page 282

Usage:

Query only

CHANnel<m>:DATA:YORigin?

CHANnel<m>:DATA:ENVELOpe:YORigin?

CALCulate:MATH<m>:DATA:YORigin?

MASK:DATA:YORigin?

LOGic<p>:DATA:YORigin?

DIGital<m>:DATA:YORigin?

REFCurve<m>:DATA:YORigin?

Return the voltage value for binary value 0 of the indicated waveform.

The commands are relevant for data conversion if binary data format is defined ([FORM UINT, 8 | 16 | 32](#)).

Suffix:

<m> 1..4

Return values:

<Yorigin> Voltage in V

Example:

See [Chapter 15.2.1.4, "Reading Waveform Data in Unsigned Integer Format"](#), on page 282

Usage:

Query only

CHANnel<m>:DATA:YINCrement?

CHANnel<m>:DATA:ENVELOpe:YINCrement?

CALCulate:MATH<m>:DATA:YINCrement?

MASK:DATA:YINCrement?

LOGic<p>:DATA:YINCrement?

DIGital<m>:DATA:YINCrement?

REFCurve<m>:DATA:YINCrement?

Return the voltage value per bit of the indicated waveform.

The commands are relevant for data conversion if binary data format is defined ([FORM UINT, 8|16|32](#)).

Suffix:

<m> 1..4

Return values:

<Yincrement> Voltage in V

Example:

See [Chapter 15.2.1.4, "Reading Waveform Data in Unsigned Integer Format"](#), on page 282

Usage:

Query only

CHANnel<m>:DATA:YRESolution?

CHANnel<m>:DATA:ENVELOpe:YRESolution?

CALCulate:MATH<m>:DATA:YRESolution?

MASK:DATA:YRESolution?

LOGic<p>:DATA:YRESolution?

DIGital<m>:DATA:YRESolution?

REFCurve<m>:DATA:YRESolution?

Return the vertical bit resolution of the indicated waveform.

The commands are relevant for data conversion if binary data format is defined ([FORM UINT, 8|16|32](#)).

Suffix:

<m> 1..4

Return values:

<Yresolution> For default waveforms, the resolution is 8 bit.
If high resolution, average or filter are set for the waveform, the resolution is 16 bit.

Example:

See [Chapter 15.2.1.4, "Reading Waveform Data in Unsigned Integer Format"](#), on page 282

Usage: Query only

15.9.2 Waveform Data Export to File

EXPort:WAVeform:SOURce	412
EXPort:WAVeform:NAME	412
EXPort:WAVeform:SAVE	412

EXPort:WAVeform:SOURce <WaveformSource>

Defines the waveform to be exported.

Parameters:

<WaveformSource> CH1..4 | D70 | D158 | MA1 | RE1..4

CH1..4

Analog channels CH1 | CH2 | CH3 | CH4

D70

Pod 1, digital channels D0 to D7 are exported together

D158

Pod 2, digital channels D8 to D15 are exported together.

MA1

Mathematic waveform

RE1..4

Reference waveforms RE1 | RE2 | RE3 | RE4

EXPort:WAVeform:NAME <FileName>

Defines the path and filename for a waveform data file that will be saved with [EXPort:WAVeform:SAVE](#). The data format and file extension is defined using [FORMat\[:DATA\]](#).

Existing files will be overwritten.

You can change the storage location, file name and/or file format manually in the [File] > "Waveforms" menu. Remote control uses the recent settings.

Parameters:

<FileName> String parameter

Example:

```
FORMAT CSV
EXPort:WAVeform:NAME "/USB_FRONT/WAVEFORMS/WFM01"
EXPort:WAVeform:SAVE
```

The waveform data is saved to WFM01.CSV.

EXPort:WAVeform:SAVE

Executes saving a waveform, for which the path and filename have been defined by [EXPort:WAVeform:NAME](#).

Usage: Event

15.9.3 Screenshots

This chapter describes remote commands used to save screenshots.

MMEMory:NAME	413
HCOPy[:IMMEDIATE]	413
HCOPy:DATA?	413
HCOPy:FORMat	414
HCOPy:LANGuage	414
HCOPy:SIZE:X?	414
HCOPy:SIZE:Y?	414
HCOPy:COLor:SCHEME	414

MMEMory:NAME <file_name>

Defines the file name to store an image of the display with [HCOPy\[:IMMEDIATE\]](#).

Parameters:

<Filename> String parameter

Example: See [Chapter 15.2.1.1, "Saving Screenshots to File"](#), on page 280

HCOPy[:IMMEDIATE]

Saves a screenshot to the specified file.

Before starting, make sure that:

- The path for storage is defined correctly by [MMEMory:CDIRECTORY](#)
- The file name for storage is defined by [MMEMory:NAME](#).

Example: See [Chapter 15.2.1.1, "Saving Screenshots to File"](#), on page 280

Usage: Event

HCOPy:DATA?

Returns the data of the image file. The file format is defined using [HCOPy:LANGuage](#) (BMP | PNG)

Return values:

<ScreenShot> 488.2 block data

Usage: Query only

HCOPY:FORMat <Format>**HCOPY:LANGuage** <Format>

Defines the format of the screenshot.

Parameters:

<Format> BMP | PNG | GIF
 BMP: Windows Bitmap Format
 PNG: Portable Network Graphic
 GIF: Graphics interchange format
 *RST: PNG

Example: See [Chapter 15.2.1.1, "Saving Screenshots to File"](#), on page 280

HCOPY:SIZE:X?

Returns the number of horizontal pixels of the oscilloscope screen.

Return values:

<Xsize> Numeric value

Usage: Query only

HCOPY:SIZE:Y?

Returns the number of vertical pixels of the oscilloscope screen.

Return values:

<Ysize> Numeric value

Usage: Query only

HCOPY:COLor:SCHEME <ColorScheme>

Defines the color mode for screenshots.

Parameters:

<ColorScheme> COLor | GRAYscale | INVerted
 INVerted inverts the colors of the output, i.e. a dark waveform is depicted on a white background.
 *RST: COLor

Example: see [Chapter 15.2.1.1, "Saving Screenshots to File"](#), on page 280

15.9.4 Instrument Settings: Mass MEMomory Subsystem

The Mass MEMomory subsystem provides commands to access the storage media and to save and reload instrument settings and data.

The R&S RTB2000 has the following storage devices indicated as drives:

- /INT: internal storage with default directories for each data type
- /USB_FRONT: USB connector on the front panel

Common computer and network drives like C:, D:, \\server\share are not available.

Name conventions

The names of files and directories have to meet the following rules:

- Only the 8.3 format with ASCII characters is supported.
- No special characters are allowed.
- Use / (slash) instead of \ (backslash).

MMEMory:DRIVes?	415
MMEMory:MSIS	415
MMEMory:MDIRectory	416
MMEMory:CDIRectory	416
MMEMory:RDIRectory	416
MMEMory:DCATalog?	417
MMEMory:DCATalog:LENGth?	417
MMEMory:CATalog?	418
MMEMory:CATalog:LENGth?	418
MMEMory:COpy	419
MMEMory:MOVE	419
MMEMory:DELeTe	419
MMEMory:DATA	420
MMEMory:STORe:STATe	420
MMEMory:LOAD:STATe	420

MMEMory:DRIVes?

Returns the storage devices available on the R&S RTB2000.

Parameters:

<Drive> List of strings, for example, ""/INT"", ""/USB_FRONT""
 /INT: internal storage
 /USB_FRONT: USB connector on the front panel

Usage: Query only

MMEMory:MSIS <Drive>

Changes the default storage location (drive).

Parameters:

<Drive> One of the available drives: /INT, or /USB_FRONT

Example:

MMEM:MSIS '/USB_FRONT'

Sets the USB flash drive connected to the front panel as storage location.

MMEMory:MDIRectory <DirectoryName>

Creates a new directory with the specified name.

Setting parameters:

<DirectoryName> String parameter
Absolute path including the storage device, or relative to the current directory.

Example: Create directory DATA on the front USB flash device, with absolute path:

```
MMEM:MDIR "/USB_FRONT/DATA"
```

Example: Create directory JANUARY in the DATA directory, with relative path:

```
MMEM:CDIR "/USB_FRONT/DATA/"  
MMEM:MDIR "JANUARY"
```

Usage: Setting only

MMEMory:CDIRectory <DirectoryName>

Specifies the current directory for file access. Before using the command, create the directory with [MMEMory:MDIRectory](#).

Setting parameters:

<DirectoryName> String parameter to specify the directory, including the storage device.

Example: `MMEM:CDIR "/USB_FRONT/DATA"`

Example: [Chapter 15.2.1.2, "Saving, Copying, and Loading Setup Data"](#), on page 281

MMEMory:RDIRectory <DirectoryName>

Deletes the specified directory.

Note: All subdirectories and all files in the specified directory and in the subdirectories will be deleted!

You cannot delete the current directory or a superior directory. In this case, the instrument returns an execution error.

Setting parameters:

<DirectoryName> String parameter, absolute path or relative to the current directory

Example: `MMEM:RDIR "/INT/TEST"`
Deletes the directory TEST in the internal storage device, and all files and subdirectories in the directory.

Usage: Setting only

MMEmory:DCATalog? <PathName>

Returns the subdirectories of the specified directory. The result corresponds to the number of strings returned by the `MMEmory:DCATalog:LENGth?` command.

Query parameters:

<PathName> String parameter
Specifies the directory.

Return values:

<FileEntry> String parameter
List of subdirectory strings separated by commas. If the specified directory does not have any subdirectory, the current and the parent directories are returned ("`.,,0`", "`.,.,,0`")

Example:

Query for directories with absolute path:

```
MMEM:DCAT? "/USB_FRONT/*"
received ".,,0",".,.,,0","DATA,,0","DATA_NEW,,0",
"SCREENSHOTS,,0"
MMEM:DCAT:LENG? "/USB_FRONT/*"
received 5
```

Example:

Query for directories in the current directory:

```
MMEM:CDIR "/USB_FRONT/DATA/"
MMEM:DCAT? "*"
received ".,,0",".,.,,0","JANUARY,,0",
"FEBRUARY,,0"
MMEM:DCAT:LENG? "*"
received 4
```

Example:

Query with filter:

```
MMEM:DCAT? "/USB_FRONT/DA*"
received "DATA,,0","DATA_NEW,,0"
MMEM:DCAT:LENG? "/USB_FRONT/DA*"
received 2
```

Usage:

Query only

MMEmory:DCATalog:LENGth? <PathName>

Returns the number of directories in specified directory. The result corresponds to the number of strings returned by the `MMEmory:DCATalog?` command.

Query parameters:

<PathName> String parameter
Specifies the directory.

Return values:

<DirCount> Number of directories.

Example:

[MMEmory:DCATalog?](#)

Usage:

Query only

MMEemory:CATalog? <PathName>[,<Format>]

Returns the a list of files contained in the specified directory. The result corresponds to the number of files returned by the `MMEemory:CATalog:LENGth?` command.

Query parameters:

<PathName>	String parameter Specifies the directory. A filter can be used to list, for example, only files of a given file type.
<Format>	ALL WTIME ALL: Extended result including file, date, time and attributes WTIME: Result including file, date, time

Return values:

<UsedMemory>	Total amount of storage currently used in the directory, in bytes.
<FreeMemory>	Total amount of storage available in the directory, in bytes.
<FileEntry>	String parameter All files of the directory are listed with their file name, format and size in bytes.

Example: Query for files in the DATA directory, with absolute path:

```
MMEM:CAT? "/USB_FRONT/DATA/*.*"
received: 511104,8633856,"MONDAY.TXT,,8",
"TUESDAY.CSV,,8"
```

Example: Query for TXT files in the DATA directory, with relative path:

```
MMEM:CDIR "/USB_FRONT/DATA" '
MMEM:CAT? "*.TXT"
received: 511104,8633856,"MONDAY.TXT,,8"
MMEM:CAT:LENGTh? "*.TXT"
received 1
```

Example: [Chapter 15.2.1.2, "Saving, Copying, and Loading Setup Data", on page 281](#)

Usage: Query only

MMEemory:CATalog:LENGth? <PathName>

Returns the number of files in the specified directory. The result corresponds to the number of files returned by the `MMEemory:CATalog?` command.

Query parameters:

<PathName>	String parameter Directory to be queried, absolute or relative path
------------	------------------------------------------------------------------------

Return values:

<Count>	Number of files.
---------	------------------

Example: [MMEemory:CATalog?](#)

Usage: Query only

MMEMory:COPY <FileSource>,<FileDestination>

Copies data to another directory on the same or different storage device. The file name can be changed, too.

Setting parameters:

<FileSource> String parameter
Name and path of the file to be copied

<FileDestination> String parameter
Name and path of the new file. If the file already exists, it is overwritten without notice.

Example: `MMEM:COPY "/INT/SETTINGS/SET001.SET",
"/USB_FRONT/SETTINGS/TESTSET1.SET"`

Example: [Chapter 15.2.1.2, "Saving, Copying, and Loading Setup Data", on page 281](#)

Usage: Setting only

MMEMory:MOVE <FileSource>,<FileDestination>

Moves an existing file to a new location.

Setting parameters:

<FileSource> String parameter
Path and name of the file to be moved

<FileDestination> String parameter
Path and name of the new file

Example: `MMEM:MOVE "/INT/SETTINGS/SET001.SET",
"/USB_FRONT/SETTINGS/SET001.SET"`

Usage: Setting only

MMEMory:DELeTe <FileSource>

Removes a file from the specified directory.

Setting parameters:

<FileSource> String parameter
File name and path of the file to be removed. If the path is omitted, the specified file will be deleted in the current directory. Filters are not allowed.

Example: [Chapter 15.2.1.2, "Saving, Copying, and Loading Setup Data", on page 281](#)

Usage: Setting only

MMEMory:DATA <FileName>,<Data>

Writes data to the specified file in the current directory `MMEMory:CDIRectory`, or reads the data.

Parameters:

<Data> 488.2 block data

The block begins with character '#'. The next digit is the length of the length information, followed by this given number of digits providing the number of bytes in the binary data attached.

Parameters for setting and query:

<FileName> String parameter containing the file name

Example: `MMEM:DATA "abc.txt", #216`This is the file
 #2: the length information has two digits
 16: the binary data has 16 bytes.
`MMEM:DATA? "abc.txt"`
 received: This is the file

Example: [Chapter 15.2.1.2, "Saving, Copying, and Loading Setup Data"](#), on page 281

MMEMory:STORe:STATe <StateNumber>,<FileName>

Saves the current device settings to the specified file in the current directory.

Setting parameters:

<StateNumber> Range: 1 to 1
 Increment: 0
 *RST: 1

<FileName> String parameter
 File name, with or without file extension

Example: `MMEM:CDIR "/USB_FRONT/DATA" '`
`MMEM:STOR:STAT 1, "MORNING.SET"`

Example: See [Chapter 15.2.1.2, "Saving, Copying, and Loading Setup Data"](#), on page 281

Usage: Setting only

MMEMory:LOAD:STATe <StateNumber>,<FileName>

Loads the device settings from the specified file in the current directory.

Setting parameters:

<StateNumber> Range: 1 to 1
 Increment: 0
 *RST: 1

<FileName> String parameter
 File name, with or without file extension

Example: MMEM:CDIR "/USB_FRONT/DATA" '
MMEM:LOAD:STAT 1, "MORNING"

Example: See [Chapter 15.2.1.2, "Saving, Copying, and Loading Setup Data"](#), on page 281

Usage: Setting only

15.10 General Instrument Setup

• Display Settings	421
• System Settings	426
• LAN Settings	430
• USB Settings	432
• Trigger Out	432
• Firmware Update	433

15.10.1 Display Settings

DISPlay:LANGUage	421
DISPlay:CLEar[:SCReen]	422
DISPlay:PERsistence:TYPE	422
DISPlay:PERsistence:TIME	422
DISPlay:PERsistence:CLEar	422
DISPlay:PERsistence[:STATe]	423
DISPlay:PERsistence:INFinite	423
DISPlay:DIALog:CLOSe	423
DISPlay:DIALog:MESSage	423
DISPlay:GRID:STYLe	424
DISPlay:INTensity:BACKlight	424
DISPlay:INTensity:GRID	424
DISPlay:INTensity:WAVEform	424
DISPlay:PALette	425
DISPlay:STYLe	425
DISPlay:GRID:ANNotation[:ENABle]	425
DISPlay:GRID:ANNotation:TRACk	425

DISPlay:LANGUage <Language>

Selects the language in which the button labels and other screen information is displayed.

Parameters:

<Language> ENGLISH | GERMAN | FRENCH | SPANISH | RUSSIAN |
 SCHINESE | TCHINESE | JAPANESE | KOREAN | ITALIAN |
 PORTUGUESE | CZECH | POLISH
 Supported languages are listed in the "Specifications" data
 sheet.
 *RST: ENGL

DISPlay:CLEAr[:SCReen]

Deletes all waveforms and measurement results.

Usage: Event

DISPlay:PERSiStence:TYPE <Type>

Defines how long every new data point remains on the screen.

Parameters:

<Type> OFF | TIME | INFINITE
OFF
 Deactivates persistence.
TIME
 Data points remain on the screen for the duration defined with
[DISPlay:PERSiStence:TIME](#).
INF
 Data points remain on the screen infinitely until persistence is
 set to OFF.
 *RST: OFF

DISPlay:PERSiStence:TIME <Time>

Persistence time if persistence is active ([DISPlay:PERSiStence\[:STATe\]](#) is set to
 TIME).

Each new data point in the diagram area remains on the screen for the duration
 defined here. .

Parameters:

<Time> Persistence time
 Range: 50e-3 to 12.8
 Increment: 50e-3
 *RST: 50e-3
 Default unit: s

DISPlay:PERSiStence:CLEAr

Removes the displayed persistent waveform from the screen.

Usage: Event

DISPlay:PERsistence[:STATe] <State>

Defines whether the waveform persists on the screen or whether the screen is refreshed continuously.

Parameters:

<State>

ON | OFF

ON

The waveform persists for the time defined using [DISPlay:PERsistence:TIME](#).

OFF

The waveform does not persist on the screen. Only the currently measured values are displayed.

*RST: OFF

DISPlay:PERsistence:INFinite <InfinitePersistence>

Sets the persistence time to infinite if [DISPlay:PERsistence\[:STATe\]](#) is ON. each new data point remains on the screen infinitely until this setting is changed or the persistence is cleared.

Parameters:

<InfinitePersistence> ON | OFF

*RST: OFF

DISPlay:DIALog:CLoSe

Closes an open message box.

Usage: Event

DISPlay:DIALog:MESSage <MessageText>

Sends a message text to the instrument and displays it in a message box.

To close the message box, use [DISPlay:DIALog:CLoSe](#).

Setting parameters:

<MessageText> String

String that contains the message.

Example:

```
DISP:DIAL:MESS 'My message'
DISP:DIAL:CLOS
```

Usage: Setting only

DISPlay:GRID:STYLe <Style>

Defines how the grid is displayed.

Parameters:

<Style> LINES | RETicle | NONE

LINES

Displays the grid as horizontal and vertical lines.

RETicle

Displays crosshairs instead of a grid.

NONE

No grid is displayed.

*RST: LIN

DISPlay:INTensity:BACKlight <Intensity>

Defines the intensity of illuminated front panel keys and rotary knobs.

Parameters:

<Intensity> Value in percent

Range: 10 to 100

Increment: 1

*RST: not available, *RST does not change the intensity

Default unit: %

DISPlay:INTensity:GRID <Intensity>

Defines the brightness of the grid lines in the diagram.

Parameters:

<Intensity> Range: 0 to 100

Increment: 1

*RST: not available, *RST does not change the intensity

Default unit: %

DISPlay:INTensity:WAVEform <Intensity>

Defines the brightness of the waveform lines in the diagram.

Parameters:

<Intensity> Range: 0 to 100

Increment: 1

*RST: not available, *RST does not change the intensity

Default unit: %

DISPlay:PALETTE <Palette>

Sets the color and brightness of the displayed waveform samples depending on their cumulative occurrence.

Parameters:

<Palette> NORMal | INVerse

NORMal

Values that occur frequently are brighter than rare values.

INVerse

Rare values are brighter than frequent values, inverse to the NORMal brightness.

FColor

Rare values are displayed in blue, while more frequent values are red and very frequent values are displayed in yellow or white, with various colors inbetween.

IFColor

Inverses the FColor setting: rare values are yellow or white while frequent values are blue.

*RST: NORM

DISPlay:STYLE <Style>

Defines how the waveform data is displayed

Parameters:

<Style> VECTors | DOTs

VECTors

Individual data points are connected by a line.

DOTs

Only the data points are displayed.

*RST: VECT

DISPlay:GRID:ANNOtation[:ENABle] <State>

Enables or disables the display of scale values and units for the x-axis and y-axis at the grid lines.

Parameters:

<State> ON | OFF

*RST: ON

DISPlay:GRID:ANNOtation:TRACk <State>

If enabled, the grid moves with the waveforms, if you change the waveform's position in horizontal or vertical direction.

If disabled, the grid remains centered on the display, if you change the waveform's position.

Parameters:

<State> ON | OFF
 *RST: OFF

15.10.2 System Settings

| | |
|--------------------------------------------|-----|
| CALibration..... | 426 |
| CALibration:STATe?..... | 426 |
| SYSTem:NAME..... | 427 |
| SYSTem:DATE..... | 427 |
| SYSTem:TIME..... | 427 |
| SYSTem:COMMunicate:INTErface[:SELEct]..... | 427 |
| SYSTem:BEEPer:CONTrol:STATe..... | 428 |
| SYSTem:BEEPer:ERRor:STATe..... | 428 |
| SYSTem:BEEPer:TRIG:STATe..... | 428 |
| SYSTem:BEEPer[:IMMediate]..... | 428 |
| SYSTem:SET..... | 428 |
| SYSTem:ERRor[:NEXT]?..... | 428 |
| SYSTem:ERRor:ALL?..... | 429 |
| SYSTem:PRESet..... | 429 |
| SYSTem:EDUCation:PRESet..... | 429 |
| SYSTem:DFPPrint?..... | 429 |
| SYSTem:TREE?..... | 429 |

CALibration

Calibration starts the self-alignment process. It can take several minutes. Consider your timeout settings.

Calibration? returns information on the state of the self-alignment. Return values ≠ 0 indicate an error.

Same as *CAL?.

Return values:

<SelfAlignment> Numeric status indicator

CALibration:STATe?

Returns the overall state of the self-alignment.

Return values:

<SelfAlignmentState> NOALignment | RUN | ERRor | OK | ABORT

NOALignment: no self-alignment was performed. Relevant for service operations.

RUN: self-alignment is running

ERRor: an error occurred.

OK: self-alignment has been performed successfully
 ABORT: self-alignment has been cancelled

Usage: Query only

SYSTem:NAME

Defines an instrument name.

Parameters:

<Name> String with max. 20 characters

SYSTem:DATE <Year>,<Month>,<Day>

Specifies the internal date for the instrument.

Parameters:

<Year> Increment: 1
 Default unit: a

<Month> Range: 1 to 12
 Increment: 1

<Day> Range: 1 to 31
 Increment: 1
 Default unit: d

Usage: SCPI confirmed

SYSTem:TIME <Hour>,<Minute>,<Second>

Specifies the internal time for the instrument.

Parameters:

<Hour> Range: 0 to 23
 Increment: 1
 Default unit: h

<Minute> Range: 0 to 59
 Increment: 1
 Default unit: min

<Second> Range: 0 to 59
 Increment: 1
 Default unit: s

Usage: SCPI confirmed

SYSTem:COMMunicate:INTERface[:SELEct]

Selects the interface for remote control and web browser access (Ethernet only).

Parameters:

<Interface> USB | Ethernet

SYSTem:BEEPer:CONTRol:STATe

Enables or disables a sound for general control events, e.g. changing the measurement type in the "Measure" menu.

Parameters:

<ControlBeep> ON | OFF

SYSTem:BEEPer:ERRor:STATe

Enables or disables the beep if an error occurs.

Parameters:

<ErrorBeep> ON | OFF

SYSTem:BEEPer:TRIG:STATe

Enables or disables the beep if a trigger occurs.

Parameters:

<TriggerBeep> ON | OFF

SYSTem:BEEPer[:IMMediate]

Generates an immediate beep. You can use this command, for example, to locate the instrument.

Usage: Event

SYSTem:SET <Setup>

Defines or queries the device settings that can be saved and load manually with [File] > "Device Settings".

Parameters:

<Setup> 488.2 block data

Usage: SCPI confirmed

SYSTem:ERRor[:NEXT]?

Returns the oldest item of the error/event queue and removes it from the queue.

Return values:

<Error> Error/event_number,"Error/event_description";[Device-dependent info]"

Example: 0, "No error"

Usage: Query only
SCPI confirmed

SYSTem:ERRor:ALL?

Returns a list of all error/event numbers and their description, and removes it from the error/event queue.

Return values:

<ErrorList> List of ErrorFormat
List of: Error/event_number,"Error/event_description>[:Device-dependent info]"
If the queue is empty, the response is 0,"No error"

Usage: Query only
SCPI confirmed

SYSTem:PRESet

Resets the instrument to the default state, has the same effect as *RST.

Usage: Event

SYSTem:EDUCation:PRESet

Deletes the password of the education mode.

Usage: Event

SYSTem:DFPRint?

Returns the device footprint of the instrument. The device footprint contains the configuration of the instrument, installed modules, installed software and software licenses. This information is written in the device footprint xml file might be useful in case of maintenance or support request.

Return values:

<DeviceFootprint> Block Data
Information as block data.

Usage: Query only

SYSTem:TREE?

Returns a list of the implemented remote commands.

Return values:

<SystemTree> List of commands

Usage: Query only

15.10.3 LAN Settings

The following commands take effect if `SYSTem:COMMunicate:INTerface[:SELect]` is set to `ETHernet`.

| | |
|----------------------------------------------------------------------|-----|
| <code>SYSTem:COMMunicate:INTerface:ETHernet:DHCP</code> | 430 |
| <code>SYSTem:COMMunicate:INTerface:ETHernet:IPADdress</code> | 430 |
| <code>SYSTem:COMMunicate:INTerface:ETHernet:SUBNet</code> | 430 |
| <code>SYSTem:COMMunicate:INTerface:ETHernet:GATeway</code> | 430 |
| <code>SYSTem:COMMunicate:INTerface:ETHernet:IPPort</code> | 431 |
| <code>SYSTem:COMMunicate:INTerface:ETHernet:VXIPort</code> | 431 |
| <code>SYSTem:COMMunicate:INTerface:ETHernet:HTTpport</code> | 431 |
| <code>SYSTem:COMMunicate:INTerface:ETHernet:TRANsfer</code> | 431 |
| <code>SYSTem:COMMunicate:INTerface:ETHernet:MACAddress?</code> | 431 |

SYSTem:COMMunicate:INTerface:ETHernet:DHCP

Enables DHCP for automatic network parameter distribution.

Parameters:

<DHCP> ON | OFF

OFF

Use the following commands to specify connection parameters:

`SYSTem:COMMunicate:INTerface:ETHernet:IPADdress`
on page 430

`SYSTem:COMMunicate:INTerface:ETHernet:SUBNet`
on page 430

`SYSTem:COMMunicate:INTerface:ETHernet:GATeway`
on page 430

SYSTem:COMMunicate:INTerface:ETHernet:IPADdress

SYSTem:COMMunicate:INTerface:ETHernet:SUBNet

SYSTem:COMMunicate:INTerface:ETHernet:GATeway

Return or specify.

- IP address of the instrument.
- IP subnet mask used by the instrument.
- IP gateway used by the instrument.

Parameters:

<FirstByte> Range: 0 to 255
Increment: 1

<SecondByte> Range: 0 to 255
Increment: 1

<ThirdByte> Range: 0 to 255
Increment: 1

<FourthByte> Range: 0 to 255
Increment: 1

SYSTem:COMMunicate:INTERface:ETHernet:IPPort <IPPort>

Returns or specifies the IP port number (default = 5025).

Parameters:

<IPPort> Range: 1024 to 65535

SYSTem:COMMunicate:INTERface:ETHernet:VXIIPort <VXIport>

Specifies the VXI-11 port number.

Parameters:

<VXIport> Range: 0 to 65535
 *RST: 1024

SYSTem:COMMunicate:INTERface:ETHernet:HTTPport <HTTPport>

Returns the HTTP port number.

Parameters:

<HTTPport> Range: 0 to 65535
 *RST: 80

SYSTem:COMMunicate:INTERface:ETHernet:TRANSfer <TransferMode>

Enables automatic transfer speed selection, or selects one of the predefined settings that corresponds to your network data rate.

Parameters:

<TransferMode> AUTO | FD10 | FD100 | HD10 | HD100
AUTO
Automatic transfer speed
FD10 | FD100 | HD10 | HD100
FD = full duplex, HD = half duplex
10 = 10 Mbps, 100 = 100 Mbps

SYSTem:COMMunicate:INTERface:ETHernet:MACaddress?

Returns the instrument's media access control address.

Return values:

<MACaddress> String data
 String parameter

Usage: Query only

15.10.4 USB Settings

The following command takes effect if `SYSTem:COMMunicate:INTerface[:SELect]` is set to `USB`.

SYSTem:COMMunicate:INTerface:USB:CLASs

Selects the USB mode.

- USB TMC (Test & Measurement Class)
- USB VCP (Virtual Com Port)
- USB MTP (Media Transfer Protocol)

Parameters:

<USBClass> TMC | VCP | MTP

15.10.5 Trigger Out

| | |
|-----------------------------------------|-----|
| <code>TRIGger:OUT:MODE</code> | 432 |
| <code>TRIGger:OUT:PLENght</code> | 432 |
| <code>TRIGger:OUT:POLarity</code> | 433 |

TRIGger:OUT:MODE <OutputMode>

Defines which signals are generated at the [Aux Out] connector.

Parameters:

<OutputMode> OFF | TRIGger | REFerence | MASK | GENerator

OFF

No output

TRIGger

Outputs a pulse when the instrument triggers.

REFerence

Outputs a 10 MHz reference frequency.

MASK

Outputs a pulse when a mask is violated. This function is only available if a mask is specified.

GENerator

Outputs the waveform that is specified using the function generator (requires option R&S RTB-B6)

*RST: OFF

TRIGger:OUT:PLENght <PulseLength>

Defines the pulse width of the pulse at the [Aux Out] front connector (at trigger event or mask violation).

Parameters:

<PulseLength> *RST: 1E-6

TRIGger:OUT:POLarity <Polarity>

Defines the polarity of the pulse at the [Aux Out] front connector (at trigger event or mask violation).

Parameters:

<Polarity> POSitive | NEGative
*RST: POS

15.10.6 Firmware Update

| | |
|--------------------------------------------------------|-----|
| DIAGnostic:UPDate:TRANsfer:OPEN | 433 |
| DIAGnostic:UPDate:TRANsfer:DATA | 433 |
| DIAGnostic:UPDate:TRANsfer:CLOSe | 433 |
| DIAGnostic:UPDate:INSTall | 434 |

DIAGnostic:UPDate:TRANsfer:OPEN <TransferItem>

Opens a data transfer for the firmware update file, and checks for errors.

Parameters:

<TransferItem> FIRMware

Example: See [Chapter 15.2.2.2, "Using DIAGnostic:UPDate:TRANsfer"](#),
on page 284

DIAGnostic:UPDate:TRANsfer:DATA <Offset>,<Checksum>,<Data>

Sends the firmware update file data to the internal RAM of the instrument

Setting parameters:

<Offset> Specifies the byte offset of the blockdata in the file.
<Checksum> CRC-16-CCITT type checksum calculated for the raw binary
data in blockdata.
<Data> Block data is composed of a header #nm containing the length
of the data followed by the data in raw binary format. Here, m is
the length of the data in byte, and n is the number of digits in m.

Example: See [Chapter 15.2.2.2, "Using DIAGnostic:UPDate:TRANsfer"](#),
on page 284

Usage: Setting only

DIAGnostic:UPDate:TRANsfer:CLOSe

Closes the file transfer.

Example: See [Chapter 15.2.2.2, "Using DIAGnostic:UPDate:TRANsfer"](#),
on page 284.

Usage: Event

DIAGnostic:UPDate:INSTall <Path>

Starts the firmware update.

Setting parameters:

<Path> Empty string

Example: See [Chapter 15.2.2.2, "Using DIAGnostic:UPDate:TRANSfer"](#),
on page 284

Usage: Setting only

15.11 Serial Bus Analysis

- [General](#)..... 434
- [SPI \(Option R&S RTB-K1\)](#)..... 436
- [I²C](#)..... 449
- [UART \(Option R&S RTB-K2\)](#)..... 459
- [CAN \(Option R&S RTB-K3\)](#)..... 468
- [LIN \(Option R&S RTB-K3\)](#)..... 484

15.11.1 General

| | |
|------------------------------------------------|-----|
| BUS:TYPE | 434 |
| BUS:STATe | 434 |
| BUS:FORMat | 435 |
| BUS:LABel | 435 |
| BUS:LABel:STATe | 435 |
| BUS:DSIGNals | 435 |
| BUS:DSIZE | 436 |
| BUS:POSition | 436 |
| BUS:RESult | 436 |

BUS:TYPE <Type>

Defines the bus or interface type for analysis. All buses require special option to the instrument.

Suffix:

 1 | 2

Parameters:

<Type> PARallel | CPARallel | I2C | SPI | SSPI | UART | CAN | LIN
*RST: PARallel

BUS:STATe <State>

Switches protocol decoding on or off.

Suffix:

 1 | 2

Parameters:<State> ON | OFF
*RST: OFF**BUS:FORMat <Format>**

Sets the decoding format for the display on the screen.

Suffix:

 1 | 2

Parameters:<Format> ASCii | HEXadecimal | BINary | DECimal | OCTal
*RST: HEX**BUS:LABel <Label>**

Defines an additional name label for the selected bus. The maximum name length is 8 characters, and only ASCII characters provided on the on-screen keypad can be used.

Suffix: 1..2
Selects the bus.**Parameters:**

<Label> String value

BUS:LABel:STATe <State>

Displays or hides the bus label. The bus label is shown on the the right side of the display.

Suffix: 1..2
Selects the bus.**Parameters:**<State> ON | OFF
*RST: ON**BUS:DSIGNals <BitsSignals>**

Displays the individual bit lines above the decoded bus line.

Suffix:

 1 | 2

Parameters:

<BitsSignals> ON | OFF
 *RST: ON

BUS:DSIZE <DisplaySize>

Sets the height of the decoded bus signal on the screen.

Suffix:

 1 | 2

Parameters:

<DisplaySize> SMAL | MEDium | LARGe | DIV2 | DIV4
DIV2 | DIV4
 2 or 4 divisions
SMAL | MEDium | LARGe
 Size of indicated bus is smaller than 2 div.
 *RST: MEDium

BUS:POSITION <Position>

Sets the vertical position of the decoded bus signal in divisions on the screen.

Suffix:

 1 | 2

Parameters:

<Position> Range: 5 to -5
 Increment: 0.02
 *RST: -3.5
 Default unit: DIV

BUS:RESULT <ShowResultTable>

Displays or hides the table of decode results.

Suffix:

 1 | 2

Parameters:

<ShowResultTable> ON | OFF

15.11.2 SPI (Option R&S RTB-K1)

The Serial Peripheral Interface (SPI) is used for communication with slow peripheral devices, in particular, for transmission of data streams.

SPI (no CS) is a Simplified SPI configuration without chip select line.

A 4-channel instrument is required for full support of the SPI (with CS) and SPI (no CS) protocols.

- [SPI \(with CS\)- Configuration](#).....437
- [SPI \(no CS\) - Configuration](#).....440
- [SPI - Trigger](#).....443
- [SPI - Decode Results](#).....445

15.11.2.1 SPI (with CS)- Configuration

Start the bus configuration with the threshold setting. Use one of the following commands:

- [CHANnel<m>:THReshold:FINDlevel](#) on page 297
- [CHANnel<m>:THReshold](#) on page 296

In all `BUS:SPI...` commands, the suffix `` selects the bus.

| | |
|-------------------------------------------------------|-----|
| BUS:SPI:CS:SOURce | 437 |
| BUS:SPI:CS:POLarity | 437 |
| BUS:SPI:CLOCK:SOURce | 438 |
| BUS:SPI:CLOCK:POLarity | 438 |
| BUS:SPI:DATA:SOURce | 438 |
| BUS:SPI:MOSI:SOURce | 438 |
| BUS:SPI:MISO:SOURce | 438 |
| BUS:SPI:DATA:POLarity | 439 |
| BUS:SPI:MOSI:POLarity | 439 |
| BUS:SPI:MISO:POLarity | 439 |
| BUS:SPI:BORDER | 439 |
| BUS:SPI:SSIZE | 440 |

BUS:SPI:CS:SOURce <Source>

Selects the input channel of the chip select line.

Suffix:

 1 | 2

Parameters:

<Source> CH1 | CH2 | CH3 | CH4 | D0..D15

*RST: CH1

BUS:SPI:CS:POLarity <Polarity>

Selects whether the chip select signal is high active (high = 1) or low active (low = 1).

Suffix:

 1 | 2

Parameters:

<Polarity> POSitive | NEGative
 POSitive = high active
 NEGative = low active
 *RST: NEGative

BUS:SPI:CLOCK:SOURce <Source>

Selects the input channel of the clock line.

Suffix:

 1 | 2

Parameters:

<Source> CH1 | CH2 | CH3 | CH4 | D0..D15
 *RST: CH1

BUS:SPI:CLOCK:POLarity <Polarity>

Selects if data is stored with the rising or falling slope of the clock. The slope marks the begin of a new bit.

Suffix:

 1 | 2

Parameters:

<Polarity> POSitive | NEGative
 POSitive: rising slope
 NEGative: falling slope
 *RST: POS

BUS:SPI:DATA:SOURce <Source>**BUS:SPI:MOSI:SOURce** <MosiSource>

Selects the input channel of the MOSI / MISO line.

Suffix:

 1 | 2

Parameters:

<MosiSource> CH1 | CH2 | CH3 | CH4 | D0..D15
 *RST: CH1

BUS:SPI:MISO:SOURce <MisoSource>

Selects the input channel of the optional MISO line.

Suffix:

 1, bus 2 is not available if the MISO source is used.

Parameters:

<MisoSource> CH1 | CH2 | CH3 | CH4 | NONE | D0..D15
 *RST: NONE

BUS:SPI:DATA:POLarity <Polarity>

Selects whether transmitted data is high active (high = 1) or low active (low = 1) on the data line.

Suffix:

 1 | 2

Parameters:

<Polarity> POSitive | NEGative
 POSitive = high active
 NEGative = low active
 *RST: POSitive

BUS:SPI:MOSI:POLarity <MosiPolarity>

Selects if transmitted data is high active (high = 1) or low active (low = 1) on the MOSI/MISO line.

Suffix:

 1 | 2

Parameters:

<MosiPolarity> ACTLow | ACTHigh
 *RST: ACTH

BUS:SPI:MISO:POLarity <MisoPolarity>

Selects whether transmitted data is high active (high = 1) or low active (low = 1) on the MISO line.

Suffix:

 1, bus 2 is not available if the MISO source is used.

Parameters:

<MisoPolarity> ACTLow | ACTHigh
 *RST: ACTH

BUS:SPI:BORDER <BitOrder>

Defines if the data of the messages starts with MSB (most significant bit) or LSB (least significant bit).

Suffix:

 1 | 2

Parameters:

<BitOrder> MSBFirst | LSBFirst
 *RST: MSBFirst

BUS:SPI:SSIZe <SymbolSize>

Sets the word length, the number of bits in a message.

Suffix:

 1 | 2

Parameters:

<SymbolSize> Range: 4 to 32
 Increment: 1
 *RST: 8
 Default unit: Bit

15.11.2.2 SPI (no CS) - Configuration

Start the bus configuration with the threshold setting. Use one of the following commands:

- [CHANnel<m>:THReshold:FINDlevel](#) on page 297
- [CHANnel<m>:THReshold](#) on page 296

In all `BUS:SSPI...` commands, the suffix `` selects the bus.

| | |
|--------------------------------------------------------|-----|
| BUS:SSPI:CLOCK:SOURce | 440 |
| BUS:SSPI:CLOCK:POLarity | 441 |
| BUS:SSPI:DATA:SOURce | 441 |
| BUS:SSPI:MOSI:SOURce | 441 |
| BUS:SSPI:MISO:SOURce | 441 |
| BUS:SSPI:DATA:POLarity | 441 |
| BUS:SSPI:MOSI:POLarity | 442 |
| BUS:SSPI:MISO:POLarity | 442 |
| BUS:SSPI:BITime | 442 |
| BUS:SSPI:BORDER | 442 |
| BUS:SSPI:SSIZe | 443 |

BUS:SSPI:CLOCK:SOURce <Source>

Selects the input channel of the clock line.

Suffix:

 1 | 2

Parameters:

<Source> CH1 | CH2 | CH3 | CH4 | D0..D15
 CH3 and CH4 are only available with 4-channel R&S RTB2000 oscilloscopes.
 *RST: CH1

BUS:SSPI:CLOCK:POLarity <Polarity>

Selects if data is stored with the rising or falling slope of the clock. The slope marks the begin of a new bit.

Suffix:

 1 | 2

Parameters:

<Polarity> POSitive | NEGative
 POSitive: rising slope
 NEGative: falling slope
 *RST: POSitive

BUS:SSPI:DATA:SOURce <Source>**BUS:SSPI:MOSI:SOURce <MosiSource>**

Selects the input channel of the MOSI / MISO line.

Suffix:

 1 | 2

Parameters:

<MosiSource> CH1 | CH2 | CH3 | CH4 | D0..D15
 *RST: CH1

BUS:SSPI:MISO:SOURce <MisoSource>

Selects the input channel of the optional MISO line.

Suffix:

 1, bus 2 is not available if the MISO source is used.

Parameters:

<MisoSource> CH1 | CH2 | CH3 | CH4 | NONE | D0..D15
 *RST: NONE

BUS:SSPI:DATA:POLarity <Polarity>

Selects whether transmitted data is high active (high = 1) or low active (low = 1) on the data line.

Suffix:

 1 | 2

Parameters:

<Polarity> POSitive | NEGative
 POSitive = high active
 NEGative = low active
 *RST: POSitive

BUS:SSPI:MOSI:POLarity <MosiPolarity>

Selects if transmitted data is high active (high = 1) or low active (low = 1) on the MOSI/MISO line.

Suffix:

 1 | 2

Parameters:

<MosiPolarity> ACTLow | ACTHigh
*RST: ACTH

BUS:SSPI:MISO:POLarity <MisoPolarity>

Selects whether transmitted data is high active (high = 1) or low active (low = 1) on the MISO line.

Suffix:

 1, bus 2 is not available if the MISO source is used.

Parameters:

<MisoPolarity> ACTLow | ACTHigh
*RST: ACTH

BUS:SSPI:BITime <BurstIdleTime>

Within the idle time the data and clock lines are low. A new frame begins when the idle time has expired and the clock line has been inactive during that time. If the time interval between the data words is shorter than the idle time, the words are part of the same frame.

Suffix:

 1 | 2

Parameters:

<BurstIdleTime> Range: 16e-9 to 838.832e-6
Increment: 16e-9
*RST: 100e-6
Default unit: s

BUS:SSPI:BORDER <BitOrder>

Defines if the data of the messages starts with MSB (most significant bit) or LSB (least significant bit).

Suffix:

 1 | 2

Parameters:

<BitOrder> MSBFirst | LSBFirst
*RST: MSBFirst

BUS:SSPI:SSIZE <SymbolSize>

Sets the word length, the number of bits in a message.

Suffix:

 1 | 2

Parameters:

<SymbolSize> Range: 4 to 32
 Increment: 1
 *RST: 8
 Default unit: Bit

15.11.2.3 SPI - Trigger

To configure the protocol trigger, make sure to set first:

- `TRIGger:A:TYPE` to BUS
- `TRIGger:A:SOURce` to SBUS1 | SBUS2

| | |
|------------------------------------------|-----|
| <code>TRIGger:A:SOURce:SPI</code> | 443 |
| <code>TRIGger:A:SPI:MODE</code> | 443 |
| <code>TRIGger:A:SPI:PATtern</code> | 444 |
| <code>TRIGger:A:SPI:PLENght</code> | 444 |
| <code>TRIGger:A:SPI:POFFset</code> | 444 |

TRIGger:A:SOURce:SPI <SpiSource>

Selects the MOSI or the MISO line as trigger source. Only relevant, if both lines are used and configured.

Parameters:

<SpiSource> MOSI | MISO

TRIGger:A:SPI:MODE <Mode>

Specifies the trigger mode for the SPI protocols (with and without CS).

Parameters:

<Mode> BStart | BEND | NTHBit | PATtern

BStart

Burst start, sets the trigger event to the start of the frame. The frame starts when the chip select signal CS changes to the active state.

BEND

Burst end, sets the trigger event to the end of the message.

NTHBit

Sets the trigger event to the specified bit number. To define the bit number, use `TRIGger:A:SPI:POFFset`.

PATtern

Sets the trigger event to a serial pattern. To define the pattern, use `TRIGger:A:SPI:PATtern`.

For a complete configuration of the pattern mode, you also have to set `TRIGger:A:SPI:PLENgtH` and `TRIGger:A:SPI:POFFset`.

*RST: BStart

TRIGger:A:SPI:PATtern <DataPattern>

Defines the bit pattern as trigger condition. The pattern length is adjusted to the number of bits defined in the pattern.

Parameters:

<DataPattern> String with max. 32 characters (4 byte + 8 bit) . Characters 0, 1 and X are allowed.

Example: `TRIG:A:SPI:PATT "0011XXXX0110"`
Sets a 12bit pattern.

TRIGger:A:SPI:PLENgtH <PatternLength>

Returns the number of bits in the previously defined bit pattern (`TRIGger:A:SPI:PATtern`). The command can also be used to shorten a previously defined bit pattern.

Parameters:

<PatternLength> Range: 1 to 32
Increment: 1
*RST: 4

Example: `TRIG:A:SPI:PATT "0011XXXX0110"`
`TRIG:A:SPI:PLEN?`
12
`TRIG:A:SPI:PLEN 4`
`TRIG:A:SPI:PATT?`
"0011"

TRIGger:A:SPI:POFFset <PatternBitOffset>

Sets the number of bits before the first bit of the pattern.

Parameters:

<PatternBitOffset> Number of ignored bits
Range: 0 to 4095
Increment: 1
*RST: 0

15.11.2.4 SPI - Decode Results

In all `BUS:SPI...` and `BUS:SSPI...` commands, the suffix `` selects the bus.

| | |
|-------------------------------------------------------------------------|-----|
| <code>BUS:SPI:FCOut?</code> | 445 |
| <code>BUS:SPI:FRAME<n>:STATus?</code> | 445 |
| <code>BUS:SPI:FRAME<n>:START?</code> | 445 |
| <code>BUS:SPI:FRAME<n>:STOP?</code> | 446 |
| <code>BUS:SPI:FRAME<n>:DATA:MOSI?</code> | 446 |
| <code>BUS:SPI:FRAME<n>:DATA:MISO?</code> | 446 |
| <code>BUS:SPI:FRAME<n>:WCOunt?</code> | 447 |
| <code>BUS:SPI:FRAME<n>:WORD<o>:START?</code> | 447 |
| <code>BUS:SPI:FRAME<n>:WORD<o>:STOP?</code> | 447 |
| <code>BUS:SPI:FRAME<n>:WORD<o>:MOSI?</code> | 448 |
| <code>BUS:SPI:FRAME<n>:WORD<o>:MISO?</code> | 448 |

BUS:SPI:FCOut?

Returns the number of decoded frames.

Suffix:

`` 1 | 2

Return values:

`<FrameCount>` Total number of decoded frames.

Usage:

Query only

BUS:SPI:FRAME<n>:STATus?

Returns the overall state of the specified frame.

Suffix:

`` 1 | 2

`<n>` *

Selects the frame.

Return values:

`<Status>` OK | INCFirst | INCLast | INSufficient

INCFirst

First frame is incomplete

INCLast

Last frame is incomplete

Usage:

Query only

BUS:SPI:FRAME<n>:START?

Returns the start time of the specified frame.

Suffix:

 1 | 2

<n> *

Return values:

<StartTime> Range: depends on sample rate, record length, and time base
 Increment: depends on the time base
 Default unit: s

Usage: Query only**BUS:SPI:FRAME<n>:STOP?**

Returns the end time of the specified frame.

Suffix:

 1 | 2

<n> *

Selects the frame.

Return values:

<StopTime> Range: depends on sample rate, record length, and time base
 Increment: depends on the time base
 Default unit: s

Usage: Query only**BUS:SPI:FRAME<n>:DATA:MOSI?**

Returns the data words of the specified frame of the MOSI line.

Suffix:

 1 | 2

<n> *

Selects the frame.

Return values:

<DataMosi> List of decimal values of data bytes

Example:

BUS:SPI:FRAM3:DATA:MOSI?
 -> 94,177,171,60,242,219,100,0

Usage: Query only**BUS:SPI:FRAME<n>:DATA:MISO?**

Returns the data words of the specified frame of the MISO line.

Suffix:

 1 | 2

<n> *
Selects the frame.

Return values:
<DataMiso> List of decimal values of data bytes

Example: BUS:SPI:FRAM3:DATA:MISO?
-> 94,177,171,60,242,219,100,0

Usage: Query only

BUS:SPI:FRAME<n>:WCOunt?

Returns the number of words in the specified frame.

Suffix:
 1 | 2
<n> *
Selects the frame.

Return values:
<WordCount> Number of words

Usage: Query only

BUS:SPI:FRAME<n>:WORD<o>:START?

Returns the start time of the specified data word.

Suffix:
 1 | 2
<n> *
Selects the frame.
<o> *
Selects the word number.

Return values:
<StartTime> Range: depends on sample rate, record length, and time base
Increment: depends on the time base
Default unit: s

Usage: Query only

BUS:SPI:FRAME<n>:WORD<o>:STOP?

Returns the end time of the specified data word.

Suffix:
 1 | 2

| | | |
|-----------------------|---------------|------------------------------------------------------|
| <n> | * | Selects the frame. |
| <o> | * | Selects the word number. |
| Return values: | | |
| <StopTime> | Range: | depends on sample rate, record length, and time base |
| | Increment: | depends on the time base |
| | Default unit: | s |
| Usage: | | Query only |

BUS:SPI:FRAME<n>:WORD<o>:MOSI?

Returns the data value of the specified word on the MOSI line.

Use this command if only one line is defined.

Suffix:

| | |
|-----|---------------------------------|
| | 1 2 |
| <n> | * |
| | Selects the frame (1...n) |
| <o> | * |
| | Selects the word number (1...o) |

Return values:

<Data> Decimal value of the data word

Usage: Query only

BUS:SPI:FRAME<n>:WORD<o>:MISO?

Returns the data value of the specified word on the optional MISO line.

Suffix:

| | |
|-----|---------------------------------|
| | 1 2 |
| <n> | * |
| | Selects the frame (1...n) |
| <o> | * |
| | Selects the word number (1...o) |

Return values:

<Data> Decimal value of the data word

Usage: Query only

15.11.3 I²C

The Inter-Integrated Circuit is a simple, low-bandwidth, low-speed protocol used for communication between on-board devices, for example, in LCD and LED drivers, RAM, EEPROM, and others.

- I²C - Configuration (Option R&S RTB-K1).....449
- I²C - Trigger.....450
- I²C - Decode Results.....452

15.11.3.1 I²C - Configuration (Option R&S RTB-K1)

Start the bus configuration with the threshold setting. Use one of the following commands:

- `CHANnel<m>:THReshold:FINDlevel` on page 297
- `CHANnel<m>:THReshold` on page 296

In all `BUS:I2C...` commands, the suffix `` selects the bus.

`BUS:I2C:CLOCK:SOURce`.....449

`BUS:I2C:DATA:SOURce`.....449

BUS:I2C:CLOCK:SOURce <Source>

Sets the input channel to which the clock line is connected.

Suffix:

 1 | 2

Parameters:

<Source> CH1 | CH2 | CH3 | CH4 | D0..D15

CH3 and CH4 are only available with 4-channel R&S RTB2000 oscilloscopes.

*RST: CH1

BUS:I2C:DATA:SOURce <Source>

Sets the input channel to which the data line is connected.

Suffix:

 1 | 2

Parameters:

<Source> CH1 | CH2 | CH3 | CH4 | D0..D15

CH3 and CH4 are only available with 4-channel R&S RTB2000 oscilloscopes.

*RST: CH1

15.11.3.2 I²C - Trigger

To configure the protocol trigger, make sure to set first:

- `TRIGger:A:TYPE` to `BUS`
- `TRIGger:A:SOURce` to `SBUS1` | `SBUS2`

| | |
|------------------------------------------|-----|
| <code>TRIGger:A:I2C:MODE</code> | 450 |
| <code>TRIGger:A:I2C:ACCess</code> | 450 |
| <code>TRIGger:A:I2C:AMode</code> | 451 |
| <code>TRIGger:A:I2C:ADDRess</code> | 451 |
| <code>TRIGger:A:I2C:PATtern</code> | 451 |
| <code>TRIGger:A:I2C:PLENght</code> | 452 |
| <code>TRIGger:A:I2C:POFFset</code> | 452 |

TRIGger:A:I2C:MODE <Mode>

Specifies the trigger mode for I²C.

Parameters:

<Mode>

`START` | `REStart` | `STOP` | `MACknowledge` | `PATtern`

START

Start of the message. The start condition is a falling slope on SDA while SCL is high.

REStart

Restarted message. The restart is a repeated start condition.

STOP

End of the message. The stop condition is a rising slope on SDA while SCL is high.

MACknowledge

Missing acknowledge. If the transfer failed, at the moment of the acknowledge bit the SCL and the SDA lines are both on high level.

PATtern

Triggers on a set of trigger conditions: read or write access of the master, to an address, or/and to a bit pattern in the message.

For a complete configuration of the pattern mode, you have to set:

`TRIGger:A:I2C:ACCess` (read/write access), and

`TRIGger:A:I2C:AMode` and `TRIGger:A:I2C:ADDRess` (address), and/or

`TRIGger:A:I2C:POFFset` and `TRIGger:A:I2C:PLENght` and `TRIGger:A:I2C:PATtern` (pattern)

*RST: `START`

TRIGger:A:I2C:ACCess <Access>

Toggles the trigger condition between Read and Write access of the master.

Parameters:

<Access> READ | WRITe
 *RST: READ

TRIGger:A:I2C:AMODe <AdrMode>

Sets the length of the slave address.

Parameters:

<AdrMode> NORMal | EXTended
 NORMal: 7 bit address
 EXTended: 10 bit address
 *RST: NORMal

TRIGger:A:I2C:ADDRess <AddressString>

Sets the address of the slave device. The address can have 7 bits or 10 bits.

Parameters:

<AddressString> String with max. 7 or 10 characters, depending on the address length. Characters 0, 1, and X are allowed, but X cannot be assigned to a specified bit. If at least one X occurs in the address, the complete address is set to X.

Example:

```
TRIG:A:I2C:AMOD NORM
TRIG:A:I2C:ADDR "1011"
TRIG:A:I2C:ADDR?
Return value (7bit address): "0001011"
```

Example:

```
TRIG:A:I2C:AMOD EXT
TRIG:A:I2C:ADDR "10X1"
TRIG:A:I2C:ADDR?
Return value (10bit address): "XXXXXXXXXX"
```

TRIGger:A:I2C:PATTern <DataPattern>

Defines the bit pattern as trigger condition. Make sure that the correct pattern length has been defined before with [TRIGger:A:I2C:PLENght](#).

Parameters:

<DataPattern> String with max. 24 characters (3 byte * 8 bit). Characters 0, 1, and X are allowed. X can be assigned to a specified bit. If you define a pattern shorter than the pattern length, the missing LSB are filled with X. If you define a pattern longer than the pattern length, the pattern string is not valid

Example:

```
TRIG:A:I2C:PLEN 2
TRIG:A:I2C:PATT "10X10000XXXX1111"
TRIG:A:I2C:PATT?
Return value (2 bytes): "10X10000XXXX1111"
```

Example:

```
TRIG:A:I2C:PLEN 1
TRIG:A:I2C:PATT "110"
TRIG:A:I2C:PATT?
Return value (1 byte): "110XXXXX"
```

TRIGger:A:I2C:PLENght <PatternLength>

Defines how many bytes are considered in the trigger condition. To set the pattern for these bytes, use [TRIGger:A:I2C:PATTern](#).

Parameters:

<PatternLength> Number of bytes
 Range: 1 to 3
 Increment: 1
 *RST: 1

TRIGger:A:I2C:POFFset <PatternByteOffset>

Sets the number of bytes before the first byte of interest, relating to the end of the address bytes.

Parameters:

<PatternByteOffset> Number of ignored bytes
 Range: 0 to 4095
 Increment: 1
 *RST: 0

15.11.3.3 I²C - Decode Results

In all `BUS:I2C...` commands, the suffix `` selects the bus.

| | |
|-------------------------------------------------------------------------------|-----|
| BUS:I2C:FCOut? | 453 |
| BUS:I2C:FRAMe<n>:DATA? | 453 |
| BUS:I2C:FRAMe<n>:STATus? | 453 |
| BUS:I2C:FRAMe<n>:STARt? | 454 |
| BUS:I2C:FRAMe<n>:STOP? | 454 |
| BUS:I2C:FRAMe<n>:AACCess? | 454 |
| BUS:I2C:FRAMe<n>:ACCess? | 454 |
| BUS:I2C:FRAMe<n>:ACOMplete? | 455 |
| BUS:I2C:FRAMe<n>:ADBStart? | 455 |
| BUS:I2C:FRAMe<n>:ADDRess? | 455 |
| BUS:I2C:FRAMe<n>:ADEVice? | 456 |
| BUS:I2C:FRAMe<n>:AMODE? | 456 |
| BUS:I2C:FRAMe<n>:ASTart? | 456 |
| BUS:I2C:FRAMe<n>:BCOut? | 457 |
| BUS:I2C:FRAMe<n>:BYTE<o>:ACCess? | 457 |
| BUS:I2C:FRAMe<n>:BYTE<o>:ACKStart? | 457 |

| | |
|---------------------------------------|-----|
| BUS:I2C:FRAMe<n>:BYTE<o>:COMPLete? | 458 |
| BUS:I2C:FRAMe<n>:BYTE<o>:STARt? | 458 |
| BUS:I2C:FRAMe<n>:BYTE<o>:VALue? | 459 |

BUS:I2C:FCOunt?

Returns the number of received frames.

Suffix:

 1 | 2

Return values:

<FrameCount> Total number of decoded frames.

Usage: Query only

BUS:I2C:FRAMe<n>:DATA?

Returns the data words of the specified frame.

Suffix:

 1 | 2

<n> *
Selects the frame.

Return values:

<DataWords> Comma-separated list of decimal values of the data bytes.

Example:

```
BUS:I2C:FRAM2:DATA?
returns four data bytes:
-> 69,158,174,161
```

Usage: Query only

BUS:I2C:FRAMe<n>:STATUs?

Returns the overall state of the frame.

Suffix:

 1 | 2

<n> *
Selects the frame.

Return values:

<State> INComplete | OK | UNEXpstop | INSufficient | ADDifferent

INComplete

The frame is not completely contained in the acquisition.

Usage: Query only

BUS:I2C:FRAMe<n>:STARt?

Returns the start time of the specified frame.

Suffix:

 1 | 2

<n> *
Selects the frame.

Return values:

<StartTime> Range: depends on sample rate, record length, and time base
Increment: depends on the time base
Default unit: s

Usage: Query only

BUS:I2C:FRAMe<n>:STOP?

Returns the end time of the specified frame.

Suffix:

 1 | 2

<n> *
Selects the frame.

Return values:

<EndTime> Range: depends on sample rate, record length, and time base
Increment: depends on the time base
Default unit: s

Usage: Query only

BUS:I2C:FRAMe<n>:AACcess?

Returns the address acknowledge bit value for the indicated frame.

Suffix:

 1 | 2

<n> *
Selects the frame.

Return values:

<Acknowledge> INComplete | ACK | NACK | EITHer

Usage: Query only

BUS:I2C:FRAMe<n>:ACcess?

Returns the transfer direction - read or write access from master to slave.

Suffix:

 1 | 2
 <n> *
 Selects the frame.

Return values:

<Access> INComplete | READ | WRITE | EITHER | UNDF
INComplete
 The frame is not completely contained in the acquisition.
UNDF
 Access is not defined.

Usage: Query only

BUS:I2C:FRAMe<n>:ACOMplete?

Returns the state of the address.

Suffix:

 1 | 2
 <n> *
 Selects the frame.

Return values:

<AddressComplete> ON | OFF
ON
 Address was received completely.

Usage: Query only

BUS:I2C:FRAMe<n>:ADBStart?

Returns the start time of the address acknowledge bit.

Suffix:

 1 | 2
 <n> *
 Selects the frame.

Return values:

<AckStartTime> Range: depends on sample rate, record length, and time base
 Increment: depends on the time base
 Default unit: s

Usage: Query only

BUS:I2C:FRAMe<n>:ADDRess?

Returns the decimal address value of the indicated frame **including** the R/W bit.

Suffix:

 1 | 2
 <n> *
 Selects the frame.

Return values:

<AddressValue> Decimal value
 Range: 0 to 2047
 Increment: 1

Usage: Query only

BUS:I2C:FRAMe<n>:ADEVice?

Returns the decimal address value of the indicated frame **without** R/W bit.

Suffix:

 1 | 2
 <n> *
 Selects the frame.

Return values:

<SlaveAddress> Decimal value
 Range: 0 to 1023
 Increment: 1

Usage: Query only

BUS:I2C:FRAMe<n>:AMODE?

Returns the address length.

Suffix:

 1 | 2
 <n> *
 Selects the frame.

Return values:

<AddressMode> BIT7 | BIT10

Usage: Query only

BUS:I2C:FRAMe<n>:AStart?

Returns the start time of the address for the indicated frame.

Suffix:

 1 | 2
 <n> *
 Selects the frame.

<0> *
Selects the byte number.

Return values:

<AckStartTime> Range: depends on sample rate, record length, and time base
Increment: depends on the time base
Default unit: s

Usage: Query only

BUS:I2C:FRAMe<n>:BYTE<o>:COMPLete?

Returns the state of the byte.

Suffix:

 1 | 2

<n> *
Selects the frame.

<o> *
Selects the byte number.

Return values:

<ByteComplete> ON | OFF
ON
Data byte was received completely.

Usage: Query only

BUS:I2C:FRAMe<n>:BYTE<o>:STARt?

Returns the start time of the specified data byte.

Suffix:

 1 | 2

<n> *
Selects the frame.

<o> *
Selects the byte number.

Return values:

<StartTime> Range: depends on sample rate, record length, and time base
Increment: depends on the time base
Default unit: s

Usage: Query only

BUS:I2C:FRAM<n>:BYTE<o>:VALue?

Returns the decimal value of the specified byte.

Suffix:

| | |
|-----|--------------------------|
| | 1 2 |
| <n> | * |
| | Selects the frame. |
| <o> | * |
| | Selects the byte number. |

Return values:

| | |
|-------------|-----------------|
| <ByteValue> | Decimal value |
| | Range: 0 to 255 |
| | Increment: 1 |

Example: BUS:I2C:FRAM2:BYTE2:VAL?
 -> 158

Usage: Query only

15.11.4 UART (Option R&S RTB-K2)

The Universal Asynchronous Receiver/Transmitter (UART) converts a word of data into serial data, and vice versa.

- [UART - Configuration](#).....459
- [UART - Trigger](#).....462
- [UART - Decode Results](#).....464

15.11.4.1 UART - Configuration

Start the bus configuration with the threshold setting. Use one of the following commands:

- [CHANnel<m>:THReshold:FINDlevel](#) on page 297
- [CHANnel<m>:THReshold](#) on page 296

In all `BUS:UART...` commands, the suffix `` selects the bus.

| | |
|-------------------------------------------------------|-----|
| BUS:UART:RX:SOURce | 460 |
| BUS:UART:DATA:SOURce | 460 |
| BUS:UART:TX:SOURce | 460 |
| BUS:UART:POLarity | 460 |
| BUS:UART:DATA:POLarity | 460 |
| BUS:UART:SSIZE | 461 |
| BUS:UART:PARity | 461 |
| BUS:UART:SBIT | 461 |
| BUS:UART:BAUDrate | 461 |
| BUS:UART:BITime | 462 |

BUS:UART:RX:SOURce <Source>

BUS:UART:DATA:SOURce <Source>

Selects the input channel of the data line.

Suffix:

 1 | 2

Parameters:

<Source> CH1 | CH2 | CH3 | CH4 | D0..D15

CH3 and CH4 are only available with 4-channel R&S RTB2000 oscilloscopes.

*RST: CH1

BUS:UART:TX:SOURce <Source>

Selects the input channel of the transmitter TX line.

Suffix:

 1, bus 2 is not available if the TX source is used.

Parameters:

<TxSource> CH1 | CH2 | CH3 | CH4 | NONE | D0..D15

NONE

Disables the optional TX line.

*RST: NONE

BUS:UART:POLarity <IdleState>

Defines the logic levels of the bus. The idle state corresponds to a logic 1, and the start bit to a logic 0.

Alternative command for [BUS:UART:DATA:POLarity](#)

Suffix:

 1 | 2

Parameters:

<IdleState> IDLLow | IDLHigh

IDLLow: idle low, low = 1

IDLHigh: idle high, high = 1

*RST: IDLH

BUS:UART:DATA:POLarity <Polarity>

Defines if the transmitted data on the bus is high (high = 1) or low (low = 1) active.

Alternative command for [BUS:UART:POLarity](#) .

Suffix:

 1 | 2

Parameters:

<Polarity> POSitive | NEGative
 POSitive = high active
 NEGative = low active
 *RST: POS

BUS:UART:SSIZE <SymbolSize>

Sets the number of data bits in a message.

Suffix:

 1 | 2

Parameters:

<SymbolSize> Range: 5 to 9
 Increment: 1
 *RST: 8
 Default unit: Bit

BUS:UART:PARity <Parity>

Defines the optional parity bit that is used for error detection.

Suffix:

 1..2
 Selects the bus.
 Note: SPI and UART protocols occupy two bus lines.

Parameters:

<Parity> ODD | EVEN | NONE
 *RST: NONE

BUS:UART:SBIT <StopBitNumber>

Sets the stop bits.

Suffix:

 1..2
 Selects the bus.
 Note: SPI and UART protocols occupy two bus lines.

Parameters:

<StopBitNumber> B1 | B1_5 | B2
 1 stop bit, 1.5 stop bits or 2 stop bits are possible.
 *RST: B1

BUS:UART:BAUDrate <Baudrate>

Sets the number of transmitted bits per second.

Suffix:

 1 | 2

Parameters:

<Baudrate> Range: 100 to 78.1E6
 Increment: 100
 *RST: 115200
 Default unit: Bit

BUS:UART:BITime <BurstIdleTime>

Sets the minimal time between two data frames (packets), that is, between the last stop bit and the start bit of the next frame.

Suffix:

 1 | 2

Parameters:

<BurstIdleTime> Range: Range depends on the bus configuration, mainly on bit rate and symbol size.
 Default unit: s

15.11.4.2 UART - Trigger

To configure the protocol trigger, make sure to set first:

- `TRIGger:A:TYPE` to BUS
- `TRIGger:A:SOURce` to SBUS1 | SBUS2

| | |
|-------------------------------------------|-----|
| <code>TRIGger:A:SOURce:UART</code> | 462 |
| <code>TRIGger:A:UART:MODE</code> | 462 |
| <code>TRIGger:A:UART:PATtern</code> | 463 |
| <code>TRIGger:A:UART:PLENght</code> | 463 |
| <code>TRIGger:A:UART:POFFset</code> | 463 |

TRIGger:A:SOURce:UART <UartSource>

Selects the transmitter or receiver line as trigger source.

Parameters:

<UartSource> RX | TX

TRIGger:A:UART:MODE <Mode>

Specifies the trigger mode for UART/RS-232 interfaces.

See also: "[UART trigger settings](#)" on page 220.

Parameters:

<Mode> BStart | SBIT | NTHSymbol | SYMBol | PATtern | PRERror | SPERror | BREak

BStart

Burst start. Sets the trigger to the begin of a data frame. The frame start is the first start bit after the idle time.

SBIT

Start bit. The start bit is the first low bit after a stop bit.

NTHSymbol

Sets the trigger to the n-th symbol of a burst.

SYMBOL

Triggers if a pattern occurs in a symbol at any position in a burst.

PATtern

Triggers on a serial pattern at a defined position in the burst.

To define the pattern, use `TRIGger:A:UART:PLENgtH` and `TRIGger:A:UART:PATtern`.

To define the position, use `TRIGger:A:UART:POFFset`.

PRERror

Parity Error: Triggers if a bit error occurred in transmission.

FERRor

Triggers on frame error.

BREak

Triggers if a start bit is not followed by a stop bit within a defined time. During the break the stop bits are at low state.

*RST: SBIT

TRIGger:A:UART:PATtern <DataPattern>

Defines the bit pattern as trigger condition.

Parameters:

<DataPattern> Binary pattern with max. 32 bit. Characters 0, 1, and X are allowed.

*RST: 1 = "00000001"

TRIGger:A:UART:PLENgtH <PatternLength>

Defines how many symbols build up the serial pattern.

Parameters:

<PatternLength> Number of symbols

Range: 1 to 4

Increment: 1

*RST: 1

TRIGger:A:UART:POFFset <PatternByteOffset>

Sets the number of symbols before the first symbol of the pattern.

Parameters:

<PatternByteOffset> Number of ignored symbols
 Range: 0 to 4095
 Increment: 1
 *RST: 0

15.11.4.3 UART - Decode Results

In all `BUS:UART...` commands, the suffix `` selects the bus.

| | |
|-----------------------------------------------------------------------------|-----|
| <code>BUS:UART:FCOut?</code> | 464 |
| <code>BUS:UART:RX:FCOut?</code> | 464 |
| <code>BUS:UART:TX:FCOut?</code> | 464 |
| <code>BUS:UART:FRAMe<n>:STARt?</code> | 465 |
| <code>BUS:UART:RX:FRAMe<n>:STARt?</code> | 465 |
| <code>BUS:UART:TX:FRAMe<n>:STARt?</code> | 465 |
| <code>BUS:UART:FRAMe<n>:STOP?</code> | 465 |
| <code>BUS:UART:RX:FRAMe<n>:STOP?</code> | 465 |
| <code>BUS:UART:TX:FRAMe<n>:STOP?</code> | 465 |
| <code>BUS:UART:FRAMe<n>:STATe?</code> | 465 |
| <code>BUS:UART:RX:FRAMe<n>:STATe?</code> | 465 |
| <code>BUS:UART:TX:FRAMe<n>:STATe?</code> | 465 |
| <code>BUS:UART:FRAMe<n>:WCOunt?</code> | 466 |
| <code>BUS:UART:RX:FRAMe<n>:WCOunt?</code> | 466 |
| <code>BUS:UART:TX:FRAMe<n>:WCOunt?</code> | 466 |
| <code>BUS:UART:FRAMe<n>:WORD<o>:SOURce?</code> | 466 |
| <code>BUS:UART:FRAMe<n>:WORD<o>:STATe?</code> | 466 |
| <code>BUS:UART:RX:FRAMe<n>:WORD<o>:STATe?</code> | 466 |
| <code>BUS:UART:TX:FRAMe<n>:WORD<o>:STATe?</code> | 466 |
| <code>BUS:UART:FRAMe<n>:WORD<o>:STARt?</code> | 467 |
| <code>BUS:UART:RX:FRAMe<n>:WORD<o>:STARt?</code> | 467 |
| <code>BUS:UART:TX:FRAMe<n>:WORD<o>:STARt?</code> | 467 |
| <code>BUS:UART:FRAMe<n>:WORD<o>:STOP?</code> | 468 |
| <code>BUS:UART:RX:FRAMe<n>:WORD<o>:STOP?</code> | 468 |
| <code>BUS:UART:TX:FRAMe<n>:WORD<o>:STOP?</code> | 468 |
| <code>BUS:UART:FRAMe<n>:WORD<o>:VALue?</code> | 468 |
| <code>BUS:UART:FRAMe<n>:WORD<o>:RXValue?</code> | 468 |
| <code>BUS:UART:FRAMe<n>:WORD<o>:TXValue?</code> | 468 |
| <code>BUS:UART:RX:FRAMe<n>:WORD<o>:VALue?</code> | 468 |
| <code>BUS:UART:TX:FRAMe<n>:WORD<o>:VALue?</code> | 468 |

BUS:UART:FCOut?**BUS:UART:RX:FCOut?****BUS:UART:TX:FCOut?**

Return the number of decoded frames on the data line.

Suffix:

 1 | 2

Return values:

<FrameCount> Total number of decoded frames.

Usage: Query only

BUS:UART:FRAME<n>:START?

BUS:UART:RX:FRAME<n>:START?

BUS:UART:TX:FRAME<n>:START?

Return the start time of the specified frame.

Suffix:

 1 | 2

<n> *
Selects the frame.

Return values:

<TxFrameStart> Time in s, range depends on sample rate, record length, and time base

Usage: Query only

BUS:UART:FRAME<n>:STOP?

BUS:UART:RX:FRAME<n>:STOP?

BUS:UART:TX:FRAME<n>:STOP?

Return the end time of the specified frame.

Suffix:

 1 | 2

<n> *
Selects the frame.

Return values:

<TxFrameStop> Time in s, range depends on sample rate, record length, and time base

Usage: Query only

BUS:UART:FRAME<n>:STATE?

BUS:UART:RX:FRAME<n>:STATE?

BUS:UART:TX:FRAME<n>:STATE?

Returns the status of the specified frame.

Suffix:

 1 | 2

<n> *
Selects the frame.

Return values:

<TxFrameState> STER | SPER | PRER | BRE | OK | INS

STER: start error, no start bit found.
 SPERr: stop error, no stop condition found.
 PRER: parity error, which indicates a transmission error.
 BRE: break condition found. A start bit is not followed by a stop bit, and the data line remains at logic 0 for longer than a UART word.
 OK: the frame is valid.
 INS: the frame is not completely contained in the acquisition. The acquired part of the frame is valid.

Usage: Query only

BUS:UART:FRAME<n>:WCOunt?
BUS:UART:RX:FRAME<n>:WCOunt?
BUS:UART:TX:FRAME<n>:WCOunt?

Returns the number of symbols in the specified frame.

Suffix:

 1 | 2
 <n> *
 Selects the frame.

Return values:

<WordCount> Number of words (symbols, characters)

Usage: Query only

BUS:UART:FRAME<n>:WORD<o>:SOURce?

Returns the line on which the specified word was transferred.

Suffix:

 1 | 2
 <n> *
 Selects the frame.
 <o> *
 Selects the word.

Return values:

<Source> TX or RX

Usage: Query only

BUS:UART:FRAME<n>:WORD<o>:STATe?
BUS:UART:RX:FRAME<n>:WORD<o>:STATe?
BUS:UART:TX:FRAME<n>:WORD<o>:STATe?

Returns the status of the specified symbol (word).

Suffix:

| | |
|-----|--------------------------|
| | 1 2 |
| <n> | * |
| | Selects the frame. |
| <o> | * |
| | Selects the word number. |

Return values:

| | |
|----------|--------------------------------------------------------------------------------------------------------------------------------------------|
| <Status> | OK FRStArT FREnd FRMErroR STERror SPERror PRERror INSufficient BREak |
| | OK: the frame is valid. |
| | FRStArT: frame start not found |
| | FREnd: frame end not found |
| | FRMErroR: error in frame |
| | STERror: start error, no start bit found. |
| | SPERror: stop error, no stop condition found. |
| | PRERror: parity error, which indicates a transmission error. |
| | INSufficient: the frame is not completely contained in the acquisition. The acquired part of the frame is valid. |
| | BREak: break condition found. A start bit is not followed by a stop bit, and the data line remains at logic 0 for longer than a UART word. |

Usage: Query only

BUS:UART:FRAMe<n>:WORD<o>:STARt?
BUS:UART:RX:FRAMe<n>:WORD<o>:STARt?
BUS:UART:TX:FRAMe<n>:WORD<o>:STARt?

Returns the start time of the specified symbol (word).

Suffix:

| | |
|-----|--------------------------|
| | 1 2 |
| <n> | * |
| | Selects the frame. |
| <o> | * |
| | Selects the word number. |

Return values:

| | |
|-------------|-------------------------------------------------------------|
| <StartTime> | Range: depends on sample rate, record length, and time base |
| | Increment: depends on the time base |
| | Default unit: s |

Usage: Query only

| | |
|-----------------------------|-----|
| • CAN - Configuration..... | 469 |
| • CAN - Trigger..... | 470 |
| • CAN - Decode Results..... | 474 |
| • CAN - Search..... | 480 |

15.11.5.1 CAN - Configuration

Start the bus configuration with the threshold setting. Use one of the following commands:

- `CHANnel<m>:THReshold:FINdlevel` on page 297
- `CHANnel<m>:THReshold` on page 296

In all `BUS:CAN...` commands, the suffix `` selects the bus.

| | |
|-------------------------------------------------|-----|
| <code>BUS:CAN:DATA:SOURce</code> | 469 |
| <code>BUS:CAN:TYPE</code> | 469 |
| <code>BUS:CAN:SAMPlepoint</code> | 470 |
| <code>BUS:CAN:BITRate</code> | 470 |

BUS:CAN:DATA:SOURce <Source>

Sets the source of the data line. All channel waveforms can be used.

Suffix:

 1 | 2

Parameters:

<Source> CH1 | CH2 | CH3 | CH4 | D0..D15

Logic channels D0..D15 are available if MSO option R&S RTB-B1 is installed.

*RST: CH1

BUS:CAN:TYPE <SignalType>

Selects the CAN-High or CAN-Low line. CAN uses both lines for differential signal transmission.

If you measure with a differential probe, connect the probe to both CAN-H and CAN-L lines, and set the type CANH.

If you use a single-ended probe, connect the probe to either CAN_L or CAN_H, and select the type accordingly.

Suffix:

 1 | 2

Parameters:

<SignalType> CANH | CANL

*RST: CANH

BUS:CAN:SAMPlEpoint <SamplePoint>

Sets the position of the sample point within the bit in percent of the nominal bit time.

See also: "[Sample Point](#)" on page 226.

Suffix:

 1 | 2

Parameters:

<SamplePoint> Range: 10 to 90
Increment: 1
*RST: 50
Default unit: %

BUS:CAN:BITRate <BitRate>

Sets the number of transmitted bits per second.

Suffix:

 1 | 2

Parameters:

<BitRate> Range: 100 to 2E06
Increment: Depends on the bit rate value
*RST: 50E03
Default unit: Bit/s

15.11.5.2 CAN - Trigger

To configure the protocol trigger, make sure to set first:

- `TRIGger:A:TYPE` to BUS
- `TRIGger:A:SOURce` to SBUS1 | SBUS2

| | |
|---------------------------------------------|-----|
| <code>TRIGger:A:CAN:TYPE</code> | 471 |
| <code>TRIGger:A:CAN:FTYPE</code> | 471 |
| <code>TRIGger:A:CAN:ITYPE</code> | 471 |
| <code>TRIGger:A:CAN:ICONdition</code> | 472 |
| <code>TRIGger:A:CAN:IDENtifier</code> | 472 |
| <code>TRIGger:A:CAN:DCONdition</code> | 472 |
| <code>TRIGger:A:CAN:DLC</code> | 472 |
| <code>TRIGger:A:CAN:DATA</code> | 473 |
| <code>TRIGger:A:CAN:ACKerror</code> | 473 |
| <code>TRIGger:A:CAN:BITSterror</code> | 473 |
| <code>TRIGger:A:CAN:CRCError</code> | 473 |
| <code>TRIGger:A:CAN:FORMerror</code> | 474 |

TRIGger:A:CAN:TYPE <TriggerType>

Specifies the trigger mode for CAN.

Parameters:

<TriggerType> STOframe | EOFframe | ID | IDDT | FTYPe | ERRCondition

STOframe

Start of frame

EOFframe

End of frame

ID

Sets the trigger to a specific message "Identifier" or an "Identifier" range.

Specify the identifier with [TRIGger:A:CAN:ITYPe](#), [TRIGger:A:CAN:ICONdition](#) and [TRIGger:A:CAN:IDENTifier](#).

IDDT

Sets the trigger to a combination of "Identifier and Data" condition. The instrument triggers at the end of the last byte of the specified data pattern.

Specify the "Identifier" (see [ID](#)), and the "Data" with [TRIGger:A:CAN:DLC](#), [TRIGger:A:CAN:DCONDITION](#) and [TRIGger:A:CAN:DATA](#).

FTYPe

Triggers on a specified "Frame".

Specify the frame type with [TRIGger:A:CAN:FTYPe](#).

ERRCondition

Identifies various errors in the frame.

Specify the "Error" with [TRIGger:A:CAN:ACKerror](#), [TRIGger:A:CAN:BITSterror](#), [TRIGger:A:CAN:CRCError](#) and [TRIGger:A:CAN:FORMerror](#).

*RST: STOF

TRIGger:A:CAN:FTYPe <FrameType>

Specifies the frame type to be triggered on if [TRIGger:A:CAN:TYPE](#) is set to [FTYPe](#).

Parameters:

<FrameType> DATA | REMote | ERRor | OVERload | ANY

*RST: ERR

TRIGger:A:CAN:ITYPe <IdentifierType>

Selects the length of the identifier: 11 bit for CAN base frames, or 29 bits for CAN extended frames.

The command is relevant if [TRIGger:A:CAN:TYPE](#) is set to [ID](#), [IDDT](#), or [FTYPe](#) (data and remote frames).

Parameters:

<IdentifierType> B11 | B29 | ANY

ANY: use if the identifier length is not relevant. Not available for trigger type ID.

*RST: B11

TRIGger:A:CAN:ICONdition <IdentifierCondition>

Sets the comparison condition: If the pattern contains at least one X (don't care), you can trigger on values equal or not equal to the specified value. If the pattern contains only 0 and 1, you can also trigger on a range greater than or lower than the specified value.

The command is relevant, if `TRIGger:A:CAN:TYPE` is set to ID or IDDT.

Parameters:

<IdentifierCondition> EQUual | NEQual | GTHan | LTHan

*RST: EQ

TRIGger:A:CAN:IDENTifier <Identifier>

Defines the identifier pattern. The pattern length is defined with `TRIGger:A:CAN:ITYPE`.

The command is relevant if `TRIGger:A:CAN:TYPE` is set to ID or IDDT.

Parameters:

<Identifier> String containing binary pattern with 11 bit or 29 bit. Characters 0, 1, and X are allowed.

TRIGger:A:CAN:DCONDITION <DataCondition>

Sets the comparison condition for data: If the pattern contains at least one X (don't care), you can trigger on values equal or not equal to the specified value. If the pattern contains only 0 and 1, you can also trigger on a range greater than or lower than the specified value.

The command is relevant if `TRIGger:A:CAN:TYPE` is set to IDDT.

Parameters:

<DataCondition> EQUal | NEQual | GTHan | LTHan

*RST: EQ

TRIGger:A:CAN:DLC <DataLength>

Defines the length of the data pattern - the number of bytes in the pattern.

The command is relevant if `TRIGger:A:CAN:TYPE` is set to IDDT.

Parameters:

<DataLength> Range: 0 to 8
 Increment: 1
 *RST: 1
 Default unit: Byte

TRIGger:A:CAN:DATA <Data>

Defines the data pattern. The number of bytes in the data pattern is defined with [TRIGger:A:CAN:DLC](#).

The command is relevant if [TRIGger:A:CAN:TYPE](#) is set to IDDT.

Parameters:

<Data> String containing binary pattern with max. 64 bit. Characters 0, 1, and X are allowed. Make sure to enter complete bytes.

TRIGger:A:CAN:ACKerror <AcknowledgeError>

Triggers on acknowledgement errors. An acknowledgement error occurs when the transmitter does not receive an acknowledgment - a dominant bit during the Ack Slot.

The command is relevant if [TRIGger:A:CAN:TYPE](#) is set to ERRCondition.

Parameters:

<AcknowledgeError> ON | OFF
 *RST: OFF

TRIGger:A:CAN:BITSterror <BitStuffingError>

Triggers on bit stuffing errors.

See also: "[Stuff Bit](#)" on page 229.

The command is relevant if [TRIGger:A:CAN:TYPE](#) is set to ERRCondition.

Parameters:

<BitStuffingError> ON | OFF
 *RST: ON

TRIGger:A:CAN:CRCErrror <CRCErrror>

Triggers on errors in the Cyclic Redundancy Check.

The command is relevant if [TRIGger:A:CAN:TYPE](#) is set to ERRCondition.

Parameters:

<CRCErrror> ON | OFF
 *RST: OFF

TRIGger:A:CAN:FORMerror <FormError>

Triggers on form errors. A form error occurs when a fixed-form bit field contains one or more illegal bits.

The command is relevant if **TRIGger:A:CAN:TYPE** is set to **ERRCondition**.

Parameters:

<FormError> ON | OFF
*RST: OFF

15.11.5.3 CAN - Decode Results

In all **BUS:CAN...** commands, the suffix **** selects the bus.

| | |
|-------------------------------------------------------------------|-----|
| BUS:CAN:FCOunt? | 474 |
| BUS:CAN:FRAME<n>:TYPE? | 474 |
| BUS:CAN:FRAME<n>:STATus? | 475 |
| BUS:CAN:FRAME<n>:START? | 475 |
| BUS:CAN:FRAME<n>:STOP? | 476 |
| BUS:CAN:FRAME<n>:DATA? | 476 |
| BUS:CAN:FRAME<n>:ACKState? | 476 |
| BUS:CAN:FRAME<n>:ACKValue? | 476 |
| BUS:CAN:FRAME<n>:CSSTate? | 477 |
| BUS:CAN:FRAME<n>:CSValue? | 477 |
| BUS:CAN:FRAME<n>:DLCState? | 477 |
| BUS:CAN:FRAME<n>:DLCValue? | 478 |
| BUS:CAN:FRAME<n>:IDSTate? | 478 |
| BUS:CAN:FRAME<n>:IDTYpe? | 478 |
| BUS:CAN:FRAME<n>:IDVAlue? | 478 |
| BUS:CAN:FRAME<n>:BSEPosition? | 479 |
| BUS:CAN:FRAME<n>:BCOunt? | 479 |
| BUS:CAN:FRAME<n>:BYTE<o>:STATe? | 479 |
| BUS:CAN:FRAME<n>:BYTE<o>:VALue? | 480 |

BUS:CAN:FCOunt?

Returns the number of received frames.

Suffix:

 1 | 2

Return values:

<FrameCount> Total number of decoded frames.

Usage:

Query only

BUS:CAN:FRAME<n>:TYPE?

Returns the type of the specified frame.

Suffix:

 1 | 2

<n> *

Selects the frame (1...n).

Return values:

<FrameType> DATA | REMote | ERR | OVLD

Data, remote, error or overload frame

Usage:

Query only

BUS:CAN:FRAME<n>:STATus?

Returns the overall state of the specified frame.

Suffix:

 1 | 2

<n> *

Selects the frame (1...n).

Return values:<FrameStatus> OK | BTST | CRCD | ACKD | CRC | EOFD | NOACK |
INSufficient

OK: frame is valid.

BTST: bit stuffing error occurred

CRCD: wrong CRC delimiter occurred

ACKD: Wrong ACK delimiter occurred

CRC: cyclic redundancy check failed

EOfD: wrong end of frame

NOACK: acknowledge is missing

INSufficient: frame is not completely contained in the acquisition.

The acquired part of the frame is valid.

Usage:

Query only

BUS:CAN:FRAME<n>:START?

Returns the start time of the specified frame.

Suffix:

 1 | 2

<n> *

Selects the frame (1...n).

Return values:

<StartTime> Default unit: s

Usage:

Query only

BUS:CAN:FRAME<n>:STOP?

Returns the end time of the specified frame.

Suffix:

 1 | 2

<n> *
Selects the frame (1...n).

Return values:

<StopTime> Default unit: s

Usage: Query only

BUS:CAN:FRAME<n>:DATA?

Returns the data words of the specified frame.

Suffix:

 1 | 2

<n> *
Selects the frame (1...n).

Return values:

<FrameData> Comma-separated list of decimal values of the data bytes.

Usage: Query only

BUS:CAN:FRAME<n>:ACKState?

Returns the state of the acknowledge field.

Suffix:

 1 | 2

<n> *
Selects the frame (1...n).

Return values:

<AcknowledgeState> OK | UNDF
UNDF: Undefined

Usage: Query only

BUS:CAN:FRAME<n>:ACKValue?

Returns the value of the acknowledge field.

Suffix:

 1 | 2

<n> *
Selects the frame (1...n).

Return values:

<AcknowledgeValue> Decimal value

Usage: Query only**BUS:CAN:FRAME<n>:CSState?**

Returns the state of the checksum.

Suffix:

 1 | 2

<n> *

Selects the frame (1...n).

Return values:

<ChecksumState> OK | UNDF

UNDF: Undefined

Usage: Query only**BUS:CAN:FRAME<n>:CSValue?**

Returns the checksum value.

Suffix:

 1 | 2

<n> *

Selects the frame (1...n).

Return values:

<ChecksumValue> Decimal value

Usage: Query only**BUS:CAN:FRAME<n>:DLCState?**

Returns the state of the data length code.

Suffix:

 1 | 2

<n> *

Selects the frame (1...n).

Return values:

<DLCState> OK | UNDF

UNDF: Undefined

Usage: Query only

BUS:CAN:FRAME<n>:DLCValue?

Returns the number of data bytes in the specified frame.

Suffix:

 1 | 2

<n> *
Selects the frame (1...n).

Return values:

<DLCValue> Non-negative integer

Usage: Query only

BUS:CAN:FRAME<n>:IDState?

Returns the state of the identifier.

Suffix:

 1 | 2

<n> *
Selects the frame (1...n).

Return values:

<IdentifierState> OK | UNDF
UNDF: Undefined

Usage: Query only

BUS:CAN:FRAME<n>:IDType?

Returns the length of the identifier: 11 bits for CAN base frames, 29 bits for CAN extended frames.

Suffix:

 1 | 2

<n> *
Selects the frame (1...n).

Return values:

<IdentifierType> ANY | B11 | B29

Usage: Query only

BUS:CAN:FRAME<n>:IDValue?

Returns the identifier of the specified frame.

Suffix:

 1 | 2

<n> *
Selects the frame (1...n).

Return values:

<IdentifierValue> Decimal value

Usage: Query only

BUS:CAN:FRAME<n>:BSEPosition?

Returns the position of the bit stuffing error in the specified frame (if available).

Suffix:

 1 | 2

<n> *
Selects the frame (1...n).

Return values:

<ErrorPosition> *RST: 0
Default unit: s

Usage: Query only

BUS:CAN:FRAME<n>:BCOunt?

Returns the number of data bytes in the specified frame.

Suffix:

 1 | 2

<n> *
Selects the frame (1...n).

Return values:

<ByteCount> Number of words (bytes)

Usage: Query only

BUS:CAN:FRAME<n>:BYTE<o>:STATE?

Returns the state of the specified data byte.

Suffix:

 1 | 2

<n> *
Selects the frame (1...n).

<o> *
Selects the byte number (1...m).

Return values:

<ByteStatus> OK | UNDF
UNDF: Undefined

Usage: Query only

BUS:CAN:FRAME<n>:BYTE<o>:VALue?

Returns the decimal value of the specified byte.

Suffix:

| | |
|-----|----------------------------------|
| | 1 2 |
| <n> | * |
| | Selects the frame (1...n). |
| <o> | * |
| | Selects the byte number (1...m). |

Return values:

| | |
|-------------|---------------|
| <ByteValue> | Decimal value |
|-------------|---------------|

Usage: Query only

15.11.5.4 CAN - Search

| | |
|-------------------------------------|-----|
| SEARCh:PROTocol:CAN:CONDition..... | 480 |
| SEARCh:PROTocol:CAN:FRAMe..... | 481 |
| SEARCh:PROTocol:CAN:ACKerror..... | 481 |
| SEARCh:PROTocol:CAN:BITSterror..... | 482 |
| SEARCh:PROTocol:CAN:CRError..... | 482 |
| SEARCh:PROTocol:CAN:FORMerror..... | 482 |
| SEARCh:PROTocol:CAN:FTYPE..... | 482 |
| SEARCh:PROTocol:CAN:ITYPe..... | 482 |
| SEARCh:PROTocol:CAN:ICONdition..... | 483 |
| SEARCh:PROTocol:CAN:IDENtifier..... | 483 |
| SEARCh:PROTocol:CAN:DLENgth..... | 483 |
| SEARCh:PROTocol:CAN:DCONdition..... | 483 |
| SEARCh:PROTocol:CAN:DATA..... | 484 |

SEARCh:PROTocol:CAN:CONDition <SearchCondition>

Sets the event or combination of events to be searched for. Depending on the selected event, further settings are required.

Parameters:

<SearchCondition> FRAME | ERRor | IDENtifier | IDData | IDERror

FRAME

Search for a frame type. Set the frame type with [SEARCh:PROTocol:CAN:FRAMe](#).

ERRor

Search for errors of one or more error types. Set the error types with [SEARCh:PROTocol:CAN:ACKerror](#), [SEARCh:PROTocol:CAN:BITSterror](#), [SEARCh:PROTocol:CAN:CRError](#) and [SEARCh:PROTocol:CAN:FORMerror](#).

IDENTifier

Search for identifier.

Specify the identifier with `SEARCH:PROTOCOL:CAN:FTYPE`, `SEARCH:PROTOCOL:CAN:ITYPE`, `SEARCH:PROTOCOL:CAN:ICONDITION` and `SEARCH:PROTOCOL:CAN:IDENTIFIER`.

IDData

Search for identifier and data.

Set the identifier (see `IDENTifier`) and the data with `SEARCH:PROTOCOL:CAN:DLENGTH`, `SEARCH:PROTOCOL:CAN:DCONDITION` and `SEARCH:PROTOCOL:CAN:DATA`.

IDERror

Search for errors that occur with a specified identifier.

Set the identifier (see `IDENTifier`) and the errors to be found (see `ERRor`)

*RST: FRAM

SEARCH:PROTOCOL:CAN:FRAME <Frame>

Selects the frame type to be searched for.

The command is relevant if `SEARCH:PROTOCOL:CAN:CONDITION` is set to `FRAME`.

Parameters:

<Frame> SOF | EOF | OVERload | ERRor | DTA11 | DTA29 | REM11 | REM29

SOF: start of frame

EOF: end of frame

OVERload: overload frame

ERRor: error frame

DTA11: data frame with 11bit identifier

DTA29: data frame with 29bit identifier

REM11: remote frame with 11bit identifier

REM29: remote frame with 29bit identifier

*RST: SOF

SEARCH:PROTOCOL:CAN:ACKerror <AcknowledgeError>

Searches for acknowledgement errors. An acknowledgement error occurs when the transmitter does not receive an acknowledgment - a dominant bit during the Ack Slot.

The command is relevant if `SEARCH:PROTOCOL:CAN:CONDITION` is set to `ERRor` or `IDERRor`.

Parameters:

<AcknowledgeError> ON | OFF

*RST: OFF

SEARCh:PROTOcol:CAN:BITSterror <BitStuffingError>

Searches for bit stuffing errors.

See also: "[Stuff Bit](#)" on page 229.

The command is relevant if `SEARCh:PROTOcol:CAN:CONDition` is set to `ERRor` or `IDERRor`.

Parameters:

<BitStuffingError> ON | OFF
 *RST: OFF

SEARCh:PROTOcol:CAN:CRCError <CRCError>

Searches for errors in the Cyclic Redundancy Check.

The command is relevant if `SEARCh:PROTOcol:CAN:CONDition` is set to `ERRor` or `IDERRor`.

Parameters:

<CRCError> ON | OFF
 *RST: OFF

SEARCh:PROTOcol:CAN:FORMerror <FormError>

Searches for form errors. A form error occurs when a fixed-form bit field contains one or more illegal bits.

The command is relevant if `SEARCh:PROTOcol:CAN:CONDition` is set to `ERRor` or `IDERRor`.

Parameters:

<FormError> ON | OFF
 *RST: OFF

SEARCh:PROTOcol:CAN:FTYPE <FrameType>

Specifies the frame type to be searched for if `SEARCh:PROTOcol:CAN:CONDition` is set to `IDENtifier`.

Parameters:

<FrameType> DATA | REMote | ANY

SEARCh:PROTOcol:CAN:ITYPE <IdType>

Selects the length of the identifier: 11 bit for CAN base frames, or 29 bits for CAN extended frames.

The command is relevant if `SEARCh:PROTOcol:CAN:CONDition` is set to `IDENtifier`, `IDData`, or `IDERRor`.

Parameters:

<IdType> B11 | B29
 *RST: B11

SEARCH:PROTocol:CAN:ICONdition <IdCondition>

Sets the comparison condition for the identifier: If the pattern contains at least one X (don't care), you can trigger on values equal or not equal to the specified value. If the pattern contains only 0 and 1, you can also trigger on a range greater than or lower than the specified value.

The command is relevant if [SEARCH:PROTocol:CAN:CONDition](#) is set to IDENTifier, IDData, or IDERror.

Parameters:

<IdCondition> EQUal | NEQual | GTHan | LTHan
 *RST: EQU

SEARCH:PROTocol:CAN:IDENtifier <Identifier>

Defines the identifier pattern. The pattern length is defined with [SEARCH:PROTocol:CAN:ITYPE](#).

The command is relevant if [SEARCH:PROTocol:CAN:CONDition](#) is set to IDENTifier, IDData, or IDERror.

Parameters:

<Identifier> String containing binary pattern with max. 29 bit. Characters 0, 1, and X are allowed.

SEARCH:PROTocol:CAN:DLENgth <DataLength>

Defines the length of the data pattern - the number of bytes in the pattern.

The command is relevant if [SEARCH:PROTocol:CAN:CONDition](#) is set to IDData.

Parameters:

<DataLength> Range: 0 to 8
 Increment: 1
 *RST: 1
 Default unit: Byte

SEARCH:PROTocol:CAN:DCONDition <DataCondition>

Sets the comparison condition for data: If the pattern contains at least one X (don't care), you can trigger on values equal or not equal to the specified value. If the pattern contains only 0 and 1, you can also trigger on a range greater than or lower than the specified value.

The command is relevant if [SEARCH:PROTocol:CAN:CONDition](#) is set to IDData.

Parameters:

<DataCondition> EQUal | NEQual | GTHan | LTHan
 *RST: EQU

SEARCh:PROTOcol:CAN:DATA <Data>

Defines the data pattern. The pattern length is defined with [SEARCh:PROTOcol:CAN:DLENGth](#).

The command is relevant if [SEARCh:PROTOcol:CAN:CONDition](#) is set to IDData.

Parameters:

<Data> String containing binary pattern with max. 64 bit. Characters 0, 1, and X are allowed. Make sure to enter complete bytes.

15.11.6 LIN (Option R&S RTB-K3)

The Local Interconnect Network (LIN) is a simple, low-cost bus system used within automotive network architectures.

Note: SPI and UART protocols occupy two bus lines (bus 1 and 2 or bus 3 and 4). If one of these buses is configured, the number of buses (suffix) is reduced. Bus 2 and/or bus 4 is not available.

- [LIN - Configuration](#).....484
- [LIN - Trigger](#).....485
- [LIN - Decode Results](#).....488
- [LIN - Search](#).....494

15.11.6.1 LIN - Configuration

Start the bus configuration with the threshold setting. Use one of the following commands:

- [CHANnel<m>:THReshold:FINDlevel](#) on page 297
- [CHANnel<m>:THReshold](#) on page 296

In all [BUS:LIN](#). . . commands, the suffix selects the bus.

- [BUS:LIN:DATA:SOURce](#).....484
- [BUS:LIN:POLarity](#).....485
- [BUS:LIN:STANdard](#).....485
- [BUS:LIN:BITRate](#).....485

BUS:LIN:DATA:SOURce <Source>

Sets the source of the data line. All channel waveforms can be used.

Suffix:

 1 | 2

Parameters:

<Source> CH1 | CH2 | CH3 | CH4 | D0..D15
 *RST: CH1

BUS:LIN:POLarity <Polarity>

Defines the idle state of the bus. The idle state is the recessive state and corresponds to a logic 1.

Suffix:

 1 | 2

Parameters:

<Polarity> IDLHigh | IDLLow
 IDLHigh: Low active, negative polarity
 IDLLow: High active, positive polarity
 *RST: IDLL

BUS:LIN:STANdard <Standard>

Selects the version of the LIN standard that is used in the DUT. The setting mainly defines the checksum version used during decoding.

The most common version is LIN 2.x. For mixed networks, or if the standard is unknown, set the LIN standard to AUTO.

Suffix:

 1 | 2

Parameters:

<Standard> V1X | V2X | J2602 | AUTO
 *RST: V1X

BUS:LIN:BITRate <BitRate>

Sets the number of transmitted bits per second.

Suffix:

 1 | 2

Parameters:

<BitRate> Range: 1 kbit/s to 2.5 Mbit/s
 *RST: 9,6E03
 Default unit: Bit/s

15.11.6.2 LIN - Trigger

To configure the protocol trigger, make sure to set first:

- `TRIGger:A:TYPE` to `BUS`

- `TRIGger:A:SOURce` to SBUS1 | SBUS2

| | |
|---------------------------------------------|-----|
| <code>TRIGger:A:LIN:TYPE</code> | 486 |
| <code>TRIGger:A:LIN:CHKSError</code> | 486 |
| <code>TRIGger:A:LIN:IPERror</code> | 487 |
| <code>TRIGger:A:LIN:SYERror</code> | 487 |
| <code>TRIGger:A:LIN:ICONdition</code> | 487 |
| <code>TRIGger:A:LIN:IDENTifier</code> | 487 |
| <code>TRIGger:A:LIN:DATA</code> | 487 |
| <code>TRIGger:A:LIN:DCONdition</code> | 488 |
| <code>TRIGger:A:LIN:DLENgth</code> | 488 |

`TRIGger:A:LIN:TYPE` <TriggerType>

Specifies the trigger mode for LIN.

Parameters:

<TriggerType> SYNC | WKFRame | ID | IDDT | ERRCondition

SYNC

Start of frame, triggers on the stop bit of the sync field.

WKFRame

Triggers after a wakeup frame.

ID

Sets the trigger to a specific identifier or an identifier range.

Set the identifier with `TRIGger:A:LIN:ICONdition` and `TRIGger:A:LIN:IDENTifier`.

IDDT

Set the identifier (see ID) and the data with `TRIGger:A:LIN:DLENgth`, `TRIGger:A:LIN:DCONdition` and `TRIGger:A:LIN:DATA`.

ERRCondition

Identifies various errors in the frame. You can select one or more error types as trigger condition.

Select the error types with `TRIGger:A:LIN:CHKSError`, `TRIGger:A:LIN:IPERror` and `TRIGger:A:LIN:SYERror`.

*RST: SYNC

`TRIGger:A:LIN:CHKSError` <ChecksumError>

Triggers on a checksum error. The checksum verifies the correct data transmission. It is the last byte of the frame response. The checksum includes not only the data but also the protected identifier (PID).

The command is relevant if `TRIGger:A:LIN:TYPE` is set to `ERRCondition`.

Parameters:

<ChecksumError> ON | OFF

*RST: ON

TRIGger:A:LIN:IPERror <IdParityError>

Triggers on a parity error. Parity bits are the bits 6 and 7 of the identifier. They verify the correct transmission of the identifier.

The command is relevant if **TRIGger:A:LIN:TYPE** is set to **ERRCondition**.

Parameters:

<IdParityError> ON | OFF
*RST: OFF

TRIGger:A:LIN:SYERror <SyncError>

Triggers if synchronization caused an error.

The command is relevant if **TRIGger:A:LIN:TYPE** is set to **ERRCondition**.

Parameters:

<SyncError> ON | OFF
*RST: OFF

TRIGger:A:LIN:ICONdition <IdentifierCondition>

Sets the comparison condition for the identifier: If the pattern contains at least one X (don't care), you can trigger on values equal or not equal to the specified value. If the pattern contains only 0 and 1, you can also trigger on a range greater than or lower than the specified value.

The command is relevant if **TRIGger:A:LIN:TYPE** is set to **ID** or **IDDT**.

Parameters:

<IdentifierCondition> EQUal | NEQual | GTHan | LTHan
*RST: EQ

TRIGger:A:LIN:IDENTifier <Identifier>

Defines the identifier pattern.

The command is relevant if **TRIGger:A:LIN:TYPE** is set to **ID** or **IDDT**.

Parameters:

<Identifier> String containing binary pattern. Characters 0, 1, and X are allowed. Enter the 6 bit identifier without parity bits, not the protected identifier.

TRIGger:A:LIN:DATA <Data>

Defines the data pattern. The number of bytes in the data pattern is defined with **TRIGger:A:LIN:DLENgth**.

The command is relevant if **TRIGger:A:LIN:TYPE** is set to **IDDT**.

Parameters:

<Data> String containing binary pattern with max. 64 bit. Characters 0, 1, and X are allowed. Make sure to enter complete bytes.

TRIGger:A:LIN:DCondition <DataCondition>

Sets the comparison condition for data: If the pattern contains at least one X (don't care), you can trigger on values equal or not equal to the specified value. If the pattern contains only 0 and 1, you can also trigger on a range greater than or lower than the specified value.

The command is relevant if `TRIGger:A:LIN:TYPE` is set to IDDT.

Parameters:

<DataCondition> EQUal | NEQual | GTHan | LTHan
*RST: EQ

TRIGger:A:LIN:DLEnGth <DataLength>

Defines the length of the data pattern - the number of bytes in the pattern.

The command is relevant if `TRIGger:A:LIN:TYPE` is set to IDDT.

Parameters:

<DataLength> Range: 1 to 8
Increment: 1
*RST: 1
Default unit: Byte

15.11.6.3 LIN - Decode Results

In all `BUS:LIN...` commands, the suffix selects the bus.

| | |
|-------------------------------------------------------------------------|-----|
| <code>BUS:LIN:FCOut?</code> | 489 |
| <code>BUS:LIN:FRAMe<n>:DATA?</code> | 489 |
| <code>BUS:LIN:FRAMe<n>:STATus?</code> | 489 |
| <code>BUS:LIN:FRAMe<n>:START?</code> | 489 |
| <code>BUS:LIN:FRAMe<n>:STOP?</code> | 490 |
| <code>BUS:LIN:FRAMe<n>:CSStAtE?</code> | 490 |
| <code>BUS:LIN:FRAMe<n>:CSVAlue?</code> | 490 |
| <code>BUS:LIN:FRAMe<n>:IDPVAlue?</code> | 491 |
| <code>BUS:LIN:FRAMe<n>:IDStAtE?</code> | 491 |
| <code>BUS:LIN:FRAMe<n>:IDVAlue?</code> | 491 |
| <code>BUS:LIN:FRAMe<n>:SYStAtE?</code> | 492 |
| <code>BUS:LIN:FRAMe<n>:SYVAlue?</code> | 492 |
| <code>BUS:LIN:FRAMe<n>:VERSiOn?</code> | 492 |
| <code>BUS:LIN:FRAMe<n>:BCOut?</code> | 492 |
| <code>BUS:LIN:FRAMe<n>:BYTE<o>:StAtE?</code> | 493 |
| <code>BUS:LIN:FRAMe<n>:BYTE<o>:VAlue?</code> | 493 |

BUS:LIN:FCOunt?

Returns the number of received frames of the active LIN bus.

Suffix:

 1 | 2

Return values:

<FrameCount> Total number of decoded frames.

Usage: Query only

BUS:LIN:FRAMe<n>:DATA?

Returns the data bytes of the specified frame.

Suffix:

 1 | 2

<n> *

Selects the frame (1...n).

Return values:

<FrameData> Comma-separated list of decimal values of the data bytes.

Usage: Query only

BUS:LIN:FRAMe<n>:STATus?

Returns the overall state of the specified frame.

Suffix:

 1 | 2

<n> *

Selects the frame (1...n).

Return values:

<FrameStatus> OK | UART | CHCKsum | PRERror | SYERror | WAKeup |
INSufficient | ERR | LENer

Usage: Query only

BUS:LIN:FRAMe<n>:START?

Returns the start time of the specified frame.

Suffix:

 1 | 2

<n> *

Selects the frame (1...n).

Return values:

<StartTime> Range: depends on sample rate, record length, and time base
 Increment: depends on the time base
 Default unit: s

Usage: Query only

BUS:LIN:FRAME<n>:STOP?

Returns the end time of the specified frame.

Suffix:

 1 | 2

<n> *

Selects the frame (1...n).

Return values:

<StopTime> Range: depends on sample rate, record length, and time base
 Increment: depends on the time base
 Default unit: s

Usage: Query only

BUS:LIN:FRAME<n>:CSState?

Returns the checksum state of the specified frame.

Suffix:

 1 | 2

<n> *

Selects the frame (1...n).

Return values:

<ChecksumState> OK | ERR | UNDF
 ERR: error
 UNDF: undefined

Usage: Query only

BUS:LIN:FRAME<n>:CSValue?

Returns the checksum value.

Suffix:

 1 | 2

<n> *

Selects the frame (1...n).

Return values:
 <ChecksumValue> Decimal value

Usage: Query only

BUS:LIN:FRAMe<n>:IDPValue?

Returns the parity value.

Suffix:

 1 | 2

<n> *

Selects the frame (1...n).

Return values:

<IdentifierParityValue>Decimal value

Usage: Query only

BUS:LIN:FRAMe<n>:IDStAtE?

Returns the identifier state of the selected frame.

Suffix:

 1 | 2

<n> *

Selects the frame (1...n).

Return values:

<IdentifierState> OK | PRERror | UVAL | INSufficient

PRERror: parity error

UVAL: unexpected value

INSufficient: the frame is not completely contained in the acquisition. The decoded part of the frame is valid.

Usage: Query only

BUS:LIN:FRAMe<n>:IDValue?

Returns the identifier value (address)

Suffix:

 1 | 2

<n> *

Selects the frame (1...n).

Return values:

<IdentifierValue> Decimal value

Usage: Query only

BUS:LIN:FRAME<n>:SYSTate?

Returns the state of the sync field for the specified frame.

Suffix:

 1 | 2

<n> *

Selects the frame (1...n).

Return values:

<SyncFieldState> OK | ERR | UNDF

ERR: error

UNDF: undefined

Usage: Query only

BUS:LIN:FRAME<n>:SYValue?

Returns the value of the synchronization field.

Suffix:

 1 | 2

<n> *

Selects the frame (1...n).

Return values:

<SyncFieldValue> Decimal value

Usage: Query only

BUS:LIN:FRAME<n>:VERSion?

Returns the version of the LIN standard for the specified frame.

Suffix:

 1 | 2

<n> *

Selects the frame (1...n).

Return values:

<FrameVersion> V1X | V2X | UNK

UNK: Unknown

Usage: Query only

BUS:LIN:FRAME<n>:BCOunt?

Returns the number of data bytes in the specified frame.

Suffix:

 1 | 2

<n> *
Selects the frame (1...n).

Return values:

<ByteCount> Number of words (bytes)

Usage: Query only

BUS:LIN:FRAMe<n>:BYTE<o>:STATe?

Returns the state of the specified data byte.

Suffix:

 1 | 2

<n> *
Selects the frame (1...n).

<o> *
Selects the byte number (1...o).

Return values:

<ByteStatus> OK | INS | UART

INS

Insufficient, the byte is not completely contained in the acquisition.

UART

At least one UART error occurred. LIN uses UART words without parity bit.

Usage: Query only

BUS:LIN:FRAMe<n>:BYTE<o>:VALue?

Returns the decimal value of the specified byte.

Suffix:

 1 | 2

<n> *
Selects the frame (1...n).

<o> *
Selects the byte number (1...o).

Return values:

<ByteValue> Decimal value

Usage: Query only

15.11.6.4 LIN - Search

| | |
|-------------------------------------|-----|
| SEARCh:PROTOcol:LIN:CONDition..... | 494 |
| SEARCh:PROTOcol:LIN:FRAMe..... | 494 |
| SEARCh:PROTOcol:LIN:IPERror..... | 495 |
| SEARCh:PROTOcol:LIN:CHKSError..... | 495 |
| SEARCh:PROTOcol:LIN:SYERror..... | 495 |
| SEARCh:PROTOcol:LIN:ICONdition..... | 495 |
| SEARCh:PROTOcol:LIN:IDENtifier..... | 496 |
| SEARCh:PROTOcol:LIN:DLENgth..... | 496 |
| SEARCh:PROTOcol:LIN:DCONdition..... | 496 |
| SEARCh:PROTOcol:LIN:DATA..... | 496 |

SEARCh:PROTOcol:LIN:CONDition <SearchCondition>

Sets the event or combination of events to be searched for. Depending on the selected event, further settings are required.

Parameters:

<SearchCondition> FRAME | ERRor | IDENtifier | IDData | IDERror

FRAMe

Search for a frame type.

Set the frame type with `SEARCh:PROTOcol:LIN:FRAMe`.

ERRor

Search for errors of one or more error types.

Set the error types with `SEARCh:PROTOcol:LIN:CHKSError`, `SEARCh:PROTOcol:LIN:IPERror` and `SEARCh:PROTOcol:LIN:SYERror`.

IDENtifier

Search for identifier.

Specify the identifier with `SEARCh:PROTOcol:LIN:ICONdition` and `SEARCh:PROTOcol:LIN:IDENtifier`.

IDData

Search for identifier and data.

Set the identifier (see `IDENtifier`) and the data with `SEARCh:PROTOcol:LIN:DLENgth`, `SEARCh:PROTOcol:LIN:DCONdition` and `SEARCh:PROTOcol:LIN:DATA`.

IDERror

Search for errors that occur with a specified identifier. Set the identifier (see `IDENtifier`) and the errors to be found (see `ERRor`).

*RST: FRAM

SEARCh:PROTOcol:LIN:FRAMe <Frame>

Selects the frame type to be searched for.

The command is relevant if `SEARCh:PROTOcol:LIN:CONDition` is set to `FRAMe`.

Parameters:

<Frame> SOF | WAKEup
 SOF: start of frame
 WAKEup: Wakeup frame
 *RST: SOF

SEARCH:PROTOCOL:LIN:IPERror <IdParityError>

Searches for parity errors.

The command is relevant if [SEARCH:PROTOCOL:LIN:CONDition](#) is set to `ERRor` or `IDERRor`.

Parameters:

<IdParityError> ON | OFF
 *RST: OFF

SEARCH:PROTOCOL:LIN:CHKSError <ChecksumError>

Searches for checksum errors.

The command is relevant if [SEARCH:PROTOCOL:LIN:CONDition](#) is set to `ERRor` or `IDERRor`.

Parameters:

<ChecksumError> ON | OFF
 *RST: OFF

SEARCH:PROTOCOL:LIN:SYERror <SyncError>

Searches for synchronization errors.

The command is relevant if [SEARCH:PROTOCOL:LIN:CONDition](#) is set to `ERRor` or `IDERRor`.

Parameters:

<SyncError> ON | OFF
 *RST: OFF

SEARCH:PROTOCOL:LIN:ICONdition <IdCondition>

Sets the comparison condition for the identifier: If the pattern contains at least one X (don't care), you can trigger on values equal or not equal to the specified value. If the pattern contains only 0 and 1, you can also trigger on a range greater than or lower than the specified value.

The command is relevant if [SEARCH:PROTOCOL:LIN:CONDition](#) is set to `IDENtifier`, `IDData` or `IDERRor`.

Parameters:

<IdCondition> EQUal | NEQual | GTHan | LTHan
 *RST: EQU

SEARCH:PROTOCOL:LIN:IDENTIFIER <Identifier>

Defines the identifier pattern.

The command is relevant if `SEARCH:PROTOCOL:LIN:CONDITION` is set to `IDENTIFIER`, `IDDATA` or `IDERROR`.

Parameters:

<Identifier> String containing binary pattern. Characters 0, 1, and X are allowed. Enter the 6 bit identifier without parity bits, not the protected identifier.

SEARCH:PROTOCOL:LIN:DLENGTH <DataLength>

Defines the length of the data pattern - the number of bytes in the pattern.

The command is relevant if `SEARCH:PROTOCOL:LIN:CONDITION` is set to `IDDATA`.

Parameters:

<DataLength> Range: 1 to 8
 Increment: 1
 *RST: 1
 Default unit: Byte

SEARCH:PROTOCOL:LIN:DCONDITION <DataCondition>

Sets the comparison condition for data: If the pattern contains at least one X (don't care), you can trigger on values equal or not equal to the specified value. If the pattern contains only 0 and 1, you can also trigger on a range greater than or lower than the specified value.

The command is relevant if `SEARCH:PROTOCOL:LIN:CONDITION` is set to `IDDATA`.

Parameters:

<DataCondition> EQUal | NEQual | GTHan | LTHan
 *RST: EQU

SEARCH:PROTOCOL:LIN:DATA <Data>

Defines the data pattern. The pattern length is defined with `SEARCH:PROTOCOL:LIN:DLENGTH`.

The command is relevant if `SEARCH:PROTOCOL:LIN:CONDITION` is set to `IDDATA`.

Parameters:

<Data> String containing binary pattern with max. 64 bit. Characters 0, 1, and X are allowed. Make sure to enter complete bytes.

15.12 Mixed Signal Option (Option R&S RTB-B1)

- [Logic Channels](#)..... 497
- [Parallel Buses](#)..... 503

15.12.1 Logic Channels

Two different sets of commands are described in this chapter:

- `LOGic<p>:xxx:xxx:`
Refer to the logic pod 1 ("D7...D0") or logic pod 2 ("D8...D15"). The suffix `<p>` selects the logic pod, range 1..2.
- `DIGital<m>:xxx:xxx:`
Refer to a specific logic channel. The suffix `<m>` selects the logic channel, range 0..15.
- [Logic Channels - Activity Display](#)..... 497
- [Logic Analyzer Configuration](#)..... 498
- [Logic Channels - Waveform Data](#)..... 501

15.12.1.1 Logic Channels - Activity Display

| | |
|---------------------------------------------------------------|-----|
| LOGic<p>:PROBe[:ENABle]? | 497 |
| LOGic<p>:CURRent:STATe:MAXimum? | 497 |
| DIGital<m>:CURRent:STATe:MAXimum? | 497 |
| LOGic<p>:CURRent:STATe:MINimum? | 497 |
| DIGital<m>:CURRent:STATe:MINimum? | 497 |

LOGic<p>:PROBe[:ENABle]?

Checks if the logic probe is connected.

Suffix:

| | |
|------------------------|------------------|
| <code><p></code> | 1..2 |
| | Selects the pod. |

Return values:

| | |
|----------------------------------|----------------------------------|
| <code><ProbeEnable></code> | 1 0 |
| | 1 = connected, 0 = not connected |

Usage: Query only

-
- LOGic<p>:CURRent:STATe:MAXimum?**
 - DIGital<m>:CURRent:STATe:MAXimum?**
 - LOGic<p>:CURRent:STATe:MINimum?**
 - DIGital<m>:CURRent:STATe:MINimum?**

Both commands together return the current status of the indicated logic channel/pod regardless of the trigger settings, and even without any acquisition.

| xxx:CURRE:STAT:MIN returns | xxx:CURRE:STAT:MAX returns | Signal |
|----------------------------|----------------------------|--------|
| 0 | 0 | Low |
| 1 | 1 | High |
| 0 | 1 | Toggle |

Suffix:

<m> 0..15
Selects the logic channel

<p> 1..2
Selects the logic pod

Return values:

<CurrentState> Range: 0 | 1

Usage: Query only

15.12.1.2 Logic Analyzer Configuration

| | |
|---------------------------------|-----|
| LOGic<p>:STATe..... | 498 |
| DIGital<m>:DISPlay..... | 498 |
| DIGital<m>:TECHnology..... | 499 |
| LOGic<p>:THReshold:UDLevel..... | 499 |
| LOGic<p>:THReshold..... | 499 |
| DIGital<m>:THReshold..... | 499 |
| LOGic<p>:HYSTeresis..... | 500 |
| DIGital<m>:HYSTeresis..... | 500 |
| DIGital<m>:SIZE..... | 500 |
| DIGital<m>:POSition..... | 500 |
| DIGital<m>:LABel..... | 501 |
| DIGital<m>:LABel:STATe..... | 501 |

LOGic<p>:STATe

Switches the logic pod on or off.

Suffix:

<p> 1..2
Selects the logic pod

Parameters:

<State> ON | OFF
*RST: OFF

DIGital<m>:DISPlay <State>

Enables and displays the indicated logic channel, or disables it.

Suffix:

<m> 0..15
Number of the logic channel

Parameters:

<State> ON | OFF
*RST: OFF

DIGital<m>:TECHnology <ThresholdMode>

Selects the threshold voltage for various types of integrated circuits and applies it to the channel group to which the indicated logic channel belongs.

Suffix:

<m> 0..15
Number of the logic channel

Parameters:

<ThresholdMode> TTL | ECL | CMOS | MANual
TTL: 1.4 V
ECL: -1.3 V
CMOS: 2.5 V
MANual: Set a user-defined threshold value with [DIGital<m>:THReshold](#)
*RST: MAN

LOGic<p>:THReshold:UDLevel**LOGic<p>:THReshold**

Selects the threshold voltage for the indicated pod.

Alternative command for [DIGital<m>:TECHnology](#).

Suffix:

<p> 1..2
Selects the logic pod

Parameters:

<ThresholdMode> TTL | ECL | CMOS | USER
TTL: 1.4 V
ECL: -1.3 V
CMOS: 2.5 V
USER: Set a user-defined threshold value with [DIGital<m>:THReshold](#)

DIGital<m>:THReshold <ThresholdLevel>

Sets the logical threshold for the pod to which the indicated logic channel belongs.

Suffix:

<m> 0..15
Number of the logic channel

Parameters:

<ThresholdLevel> *RST: 1.4
Default unit: V

LOGic<p>:HYSTeresis**DIGital<m>:HYSTeresis <Hysteresis>**

Defines the size of the hysteresis to avoid the change of signal states due to noise. The setting applies to the logic pod to which the indicated logic channel belongs.

Suffix:

<m> 0..15
Selects the logic channel.

<p> 1..2
Selects the logic pod.

Parameters:

<Hysteresis> SMALL | MEDIUM | LARGE

DIGital<m>:SIZE <Size>

Sets the vertical size of the indicated digital channel.

Suffix:

<m> 0..15
Number of the logic channel

Parameters:

<Size> Specifies the number of divisions per logic channel.
Range: 0.2 to 8
Increment: 0.1
*RST: 0.3
Default unit: DIV

DIGital<m>:POSition <Position>

Sets the vertical position of the indicated vertical channel.

Suffix:

<m> 0..15
Number of the logic channel

Parameters:

<Position> Vertical position in divisions
Default unit: DIV

DIGital<m>:LABel <Label>

Defines a label for the indicated logic channel.

Suffix:

<m> 0..15
 Number of the logic channel

Parameters:

<Label> String value
 String parameter

Example:

DIGital4:LABel "Data"
 Defines the label "Data" for logic channel D4.

DIGital<m>:LABel:STATe <State>

Displays or hides the label of the indicated logic channel.

Suffix:

<m> 0..15
 Number of the logic channel

Parameters:

<State> ON | OFF
 *RST: OFF

15.12.1.3 Logic Channels - Waveform Data

For data queries and conversion, consider also the following commands:

- [FORMat\[:DATA\]](#) on page 400
- [DIGital<m>:DATA:XINCrement?](#) on page 410
- [DIGital<m>:DATA:XORigin?](#) on page 409
- [DIGital<m>:DATA:YINCrement?](#) on page 411
- [DIGital<m>:DATA:YORigin?](#) on page 410
- [DIGital<m>:DATA:YRESolution?](#) on page 411
- [LOGic<p>:DATA:XINCrement?](#) on page 410
- [LOGic<p>:DATA:XORigin?](#) on page 409
- [LOGic<p>:DATA:YINCrement?](#) on page 411
- [LOGic<p>:DATA:YORigin?](#) on page 410
- [LOGic<p>:DATA:YRESolution?](#) on page 411

| | |
|-----------------------------------------------------|-----|
| LOGic<p>:DATA? | 502 |
| DIGital<m>:DATA? | 502 |
| LOGic<p>:DATA:HEADer? | 502 |
| DIGital<m>:DATA:HEADer? | 502 |
| LOGic<p>:DATA:POINts | 503 |
| DIGital<m>:DATA:POINts | 503 |

LOGic<p>:DATA?**DIGital<m>:DATA?**

Returns the data of the specified logic channel/pod for transmission from the instrument to the controlling computer. The waveforms data can be used in MATLAB, for example.

To set the export format, use `FORMat [:DATA]`.

To set the range of samples to be returned, use `DIGital<m>:DATA:POINTs`.

Suffix:

<m> 0..15
Selects the logic channel

<p> 1..2
Selects the logic pod

Parameters:

<WaveformData> List of values according to the format settings.

Example:

```
FORM ASC,0
DIG1:DATA?
1,1,1,1,1,1,0,0,0,0,0,0,...
```

Usage:

Query only

LOGic<p>:DATA:HEADer?**DIGital<m>:DATA:HEADer?**

Returns information on the waveform of the specified logic channel/pod.

Table 15-6: Header data

| Position | Meaning | Example |
|----------|--------------------------------------------------|-------------------------|
| 1 | XStart in s | -9.477E-008 = -94,77 ns |
| 2 | XStop in s | 9.477E-008 = 94,77 ns |
| 3 | Record length of the waveform in Samples | 200000 |
| 4 | Number of values per sample interval, usually 1. | 1 |

Suffix:

<m> 0..15
Selects the logic channel

<p> 1..2
Selects the logic pod

Parameters:

<Header> Comma-separated value list
Example: `-9.477E-008,9.477E-008,200000,1`

Usage:

Query only

LOGic<p>:**DATA:POINts** <PointSelection>

DIGital<m>:**DATA:POINts** <PointSelection>

As a setting, the command selects a range of samples that will be returned with [DIGital](#)<m>:[DATA?](#). As a query, it returns the number of returned samples for the selected range.

Depending on the current settings, the memory can contain more data samples than the screen is able to display. In this case, you can decide which data will be saved: samples stored in the memory or only the displayed samples.

Note: The sample range can be changed only in STOP mode. If the acquisition is running, DEF is always used automatically. If the acquisition has been stopped, data can be read from the memory, and all settings are available.

Suffix:

| | |
|-----|------------------------------------|
| <m> | 0..15
Selects the logic channel |
| <p> | 1..2
Selects the logic pod |

Setting parameters:

<PointSelection> DEFault | MAXimum | DMAXimum

Sets the range for data queries.

DEFault

Waveform points that are visible on the screen. At maximum waveform rate, the instrument stores more samples than visible on the screen, and DEF returns less values than acquired.

MAXimum

All waveform samples that are stored in the memory. Only available if acquisition is stopped.

DMAXimum

Display maximum: Waveform samples stored in the current waveform record but only for the displayed time range. At maximum waveform rate, the instrument stores more samples than visible on the screen, and DMAX returns more values than DEF. Only available if acquisition is stopped.

*RST: DEFault

Return values:

<Points> Number of data points in the selected range.

Default unit: Samples

See also: [CHANnel](#)<m>:[DATA:POINts](#)

15.12.2 Parallel Buses

- [Parallel Bus - Line Configuration](#).....504
- [Parallel Clocked Bus Configuration](#).....505
- [Parallel Buses - Decode Results](#).....506

15.12.2.1 Parallel Bus - Line Configuration

BUS:PARAllel:WIDTh <BusWidth>

Sets the number of lines to be analyzed for the parallel bus.

Suffix:

 1..2
Selects the parallel bus.

Parameters:

<BusWidth> Maximum number is the number of input channels.
Range: 1 to 4
Increment: 1
*RST: 4
Default unit: Bit

BUS:CPARAllel:WIDTh <BusWidth>

Sets the number of lines to be analyzed for the parallel clocked bus.

Suffix:

 1..2
Selects the parallel bus.

Parameters:

<BusWidth> Range: 1 to 15 (clock only) or 14 (clock and CS)
Increment: 1
*RST: 4
Default unit: Bit

BUS:PARAllel:DATA<m>:SOURce <DataSource>

BUS:CPARAllel:DATA<m>:SOURce <DataSource>

Defines the logic channel that is assigned to the selected bit.

Use the command for each bit of the bus.

Suffix:

 1..2
Selects the parallel bus.

<m> Sets the bit number.

Parameters:

<DataSource> D0..D15

Example:

```
BUS:PARAllel:Width 4
BUS:PARAllel:DATA0:SOURce D8
BUS:PARAllel:DATA1:SOURce D9
BUS:PARAllel:DATA2:SOURce D10
BUS:PARAllel:DATA3:SOURce D11
```

15.12.2.2 Parallel Clocked Bus Configuration

| | |
|------------------------------------|-----|
| BUS:CPARAllel:CLOCK:SOURce..... | 505 |
| BUS:CPARAllel:CLOCK:SLOPe..... | 505 |
| BUS:CPARAllel:CS:ENABle..... | 505 |
| BUS:CPARAllel:CS:SOURce..... | 505 |
| BUS:CPARAllel:CS:POLarity..... | 506 |

BUS:CPARAllel:CLOCK:SOURce <ClockSource>

Selects the logic channel that is used as clock line.

Suffix:

 1..2
Selects the parallel bus.

Parameters:

<ClockSource> D0..D15
*RST: D0

BUS:CPARAllel:CLOCK:SLOPe <ClockSlope>

Selects if the data is sampled on the rising or falling slope of the clock, or on both edges (EITHer). The clock slope marks the begin of a new bit.

Suffix:

 1..2
Selects the parallel bus.

Parameters:

<ClockSlope> POSitive | NEGative | EITHer

BUS:CPARAllel:CS:ENABle <ChipSelectEnable>

Enables and disables the chip select line.

Suffix:

 1..2
Selects the parallel bus.

Parameters:

<ChipSelectEnable> ON | OFF
*RST: ON

BUS:CPARAllel:CS:SOURce <ChipSelectSource>

Selects the logic channel that is used as chip select line.

Suffix:

 1..2
Selects the parallel bus.

Parameters:

<ChipSelectSource> D0..D15
 *RST: D1

BUS:CPARAllel:CS:POLarity <Polarity>

Selects if the chip select signal is high active (high = 1) or low active (low = 1).

Suffix:

 1..2
 Selects the parallel bus.

Parameters:

<Polarity> POSitive | NEGative
 POSitive = high active
 NEGative = low active

15.12.2.3 Parallel Buses - Decode Results

The commands to query results of decoded parallel clocked and unclocked buses are similar and described together in this chapter..

| | |
|---------------------------------------|-----|
| BUS:PARAllel:FCOunt?..... | 506 |
| BUS:CPARAllel:FCOunt?..... | 506 |
| BUS:PARAllel:FRAMe<n>:DATA?..... | 506 |
| BUS:CPARAllel:FRAMe<n>:DATA?..... | 506 |
| BUS:PARAllel:FRAMe<n>:STATe?..... | 507 |
| BUS:CPARAllel:FRAMe<n>:STATe?..... | 507 |
| BUS:PARAllel:FRAMe<n>:STARt?..... | 507 |
| BUS:CPARAllel:FRAMe<n>:STARt?..... | 507 |
| BUS:PARAllel:FRAMe<n>:STOP?..... | 507 |
| BUS:CPARAllel:FRAMe<n>:STOP?..... | 507 |

BUS:PARAllel:FCOunt?**BUS:CPARAllel:FCOunt?**

Returns the number of decoded frames.

Suffix:

 1..2
 Selects the parallel bus.

Return values:

<FrameCount> Total number of decoded frames.

Usage: Query only

BUS:PARAllel:FRAMe<n>:DATA?**BUS:CPARAllel:FRAMe<n>:DATA?**

Returns the data words of the specified frame.

Suffix:

 1..2
Selects the parallel bus.

<n> *
Selects the frame.

Return values:

<FrameData> List of decimal values of data words

Usage: Query only

BUS:PARAllel:FRAMe<n>:STATe?**BUS:CPARAllel:FRAMe<n>:STATe?**

Returns the overall state of the specified frame.

Suffix:

 1..2
Selects the parallel bus.

<n> *
Selects the frame.

Return values:

<FrameStatus> OK | ERRor | INSufficient

Usage: Query only

BUS:PARAllel:FRAMe<n>:START?**BUS:CPARAllel:FRAMe<n>:START?**

Returns the start time of the specified frame.

Suffix:

 1..2
Selects the parallel bus.

<n> *
Selects the frame.

Return values:

<StartTime> Default unit: s

Usage: Query only

BUS:PARAllel:FRAMe<n>:STOP?**BUS:CPARAllel:FRAMe<n>:STOP?**

Returns the end time of the specified frame.

Suffix:

 1..2
Selects the parallel bus.

<n> *
Selects the frame.

Return values:

<StopTime> Default unit: s

Usage: Query only

15.13 Signal Generation (Option R&S RTB-B6)

15.13.1 Function Generator

15.13.1.1 Basic Settings of the Function Generator

| | |
|---------------------------------------------|-----|
| WGENerator:FUNction..... | 508 |
| WGENerator:VOLTage..... | 508 |
| WGENerator:VOLTage:OFFSet..... | 509 |
| WGENerator:FREQuency..... | 509 |
| WGENerator:FUNction:PULSe:DCYCLE..... | 509 |
| WGENerator:FUNction:PULSe:ETIME..... | 509 |
| WGENerator:FUNction:EXPOntial:POLarity..... | 509 |
| WGENerator:FUNction:RAMP:POLarity..... | 509 |
| WGENerator:NOISe:ABSolute..... | 510 |
| WGENerator:NOISe:RELative..... | 510 |
| WGENerator:OUTPut:DESTination..... | 510 |
| WGENerator:OUTPut:LOAD..... | 510 |
| WGENerator:OUTPut[:ENABLE]..... | 510 |

WGENerator:FUNction <Function>

Selects the function to be generated.

Parameters:

<Function> DC | SINusoid | SQUare | PULSe | TRIangle | RAMP | SINC |
ARBItrary | EXPOntial

WGENerator:VOLTage <Amplitude>

Defines the amplitude value (peak-to-peak value) of the selected generator function.

Parameters:

<Amplitude> Numeric value
Range: 6.0000E-02 to 6.0000E+00
*RST: 5.0000E-01
Default unit: Vpp

WGENerator:VOLTage:OFFSet <Offset>

Sets the DC offset of the selected generator function.

Parameters:

| | |
|----------|------------------------------------|
| <Offset> | Numeric value |
| | Range: -3.00000E+00 to 3.00000E+00 |
| | *RST: 0.00E+00 |
| | Default unit: V |

WGENerator:FREQuency <Frequency>

Defines the frequency.

Parameters:

| | | |
|-------------|--------|------------------------------------------------------------------------|
| <Frequency> | Range: | Depends on the selected function. For details, refer to the datasheet. |
| | *RST: | 10 kHz |

WGENerator:FUNCTion:PULSe:DCYCLE <DutyCycle>

Defines the duty cycle value of the generator function pulse.

Parameters:

| | |
|-------------|-------------------------------|
| <DutyCycle> | Numeric value |
| | Range: 1.000E+01 to 9.000E+01 |
| | *RST: 2.500E+01 |
| | Default unit: % |

WGENerator:FUNCTion:PULSe:ETImE <EdgeTime>

Sets the pulse edge time.

Parameters:

| |
|------------|
| <EdgeTime> |
|------------|

WGENerator:FUNCTion:EXPonential:POLarity <Polarity>

Sets the polarity of the generator function exponential.

Parameters:

| | |
|------------|---------------------|
| <Polarity> | POSitive NEGative |
|------------|---------------------|

WGENerator:FUNCTion:RAMP:POLarity <Polarity>

Sets the polarity of the generator function ramp.

Parameters:

| | |
|------------|---------------------|
| <Polarity> | POSitive NEGative |
| | *RST: NEG |

WGENerator:NOISe:ABSolute <AbsoluteNoise>

Sets the noise of the waveform in volts.

Parameters:

<AbsoluteNoise>

WGENerator:NOISe:RELative <RelativeNoise>

Sets the noise of the generated waveform in percentage of the amplitude.

Parameters:

<RelativeNoise>

WGENerator:OUTPut:DESTination <Destination>

Sets the output connector for the function generator waveform.

Parameters:

<Destination> BNC | P3

WGENerator:OUTPut:LOAD <Load>

Select the user load, the load of the DUT at its connection. You can select either a "50Ω" or a "High-Z" (high input impedance) load.

Parameters:

<Load> HIGHz | R50

WGENerator:OUTPut[:ENABLE] <OutputEnable>

Enables the function generator and outputs the waveform.

Parameters:

<OutputEnable> ON | OFF

15.13.1.2 Arbitrary Waveform Setup

| | |
|---------------------------------------|-----|
| WGENerator:ARBitrary:SOURce..... | 510 |
| WGENerator:ARBitrary:RANGe:START..... | 511 |
| WGENerator:ARBitrary:RANGe:STOP..... | 511 |
| WGENerator:ARBitrary:UPDate..... | 511 |
| WGENerator:ARBitrary[:FILE]:NAME..... | 511 |
| WGENerator:ARBitrary[:FILE]:OPEN..... | 511 |
| WGENerator:ARBitrary:VISible..... | 511 |

WGENerator:ARBitrary:SOURce <Source>

Selects the input channel for an arbitrary function to be generated.

Parameters:

<Source> CH1 | CH2 | CH3 | CH4
 *RST: CH1

WGENerator:ARbitrary:RANGe:START <StartTime>

Sets the start time of the copied waveform part.

Parameters:

<StartTime> Default unit: s

WGENerator:ARbitrary:RANGe:STOP <StopTime>

Sets the end time of the copied waveform part.

Parameters:

<StopTime> Default unit: s

WGENerator:ARbitrary:UPDate

Loads the waveform from the selected signal source ([WGENerator:ARbitrary:SOURce](#)).

Usage: Event

WGENerator:ARbitrary[:FILE]:NAME <FilePath>

Sets the file path and the file for an arbitrary waveform to be loaded.

Parameters:

<FilePath> string
 *RST: "

WGENerator:ARbitrary[:FILE]:OPEN

Loads the arbitrary waveform, that is selected with the [WGENerator:ARbitrary\[:FILE\]:NAME](#) command.

Usage: Event

WGENerator:ARbitrary:VISible <ArbWaveformVisible>

Enables the display of the arbitrary waveform.

Parameters:

<ArbWaveformVisible>ON | OFF
 *RST: OFF

15.13.1.3 Burst Settings

| | |
|-------------------------------|-----|
| WGENerator:BURSt:ITIME..... | 512 |
| WGENerator:BURSt:NCYCLe..... | 512 |
| WGENerator:BURSt:PHASe..... | 512 |
| WGENerator:BURSt[:STATe]..... | 512 |

WGENerator:BURSt:ITIME <IdleTime>

Sets the idle time between two burst cycles.

Parameters:

| | | |
|------------|---------------|-----------|
| <IdleTime> | Range: | 28n to 17 |
| | *RST: | 100u |
| | Default unit: | s |

WGENerator:BURSt:NCYCLe <NumberOfCycles>

Sets the number of times the generator outputs one cycle of the waveform per burst.

Parameters:

| | | |
|------------------|------------|-----------|
| <NumberOfCycles> | Range: | 1 to 1023 |
| | Increment: | 1 |
| | *RST: | 1 |

WGENerator:BURSt:PHASe <PhaseOffset>

Sets the start phase of the burst.

Parameters:

| | | |
|---------------|---------------|----------|
| <PhaseOffset> | Range: | 0 to 360 |
| | Increment: | 0.1 |
| | *RST: | 0 |
| | Default unit: | Degree |

WGENerator:BURSt[:STATe] <Enable>

Enables or disables the burst. for the generator.

Parameters:

| | |
|----------|-----------|
| <Enable> | ON OFF |
| | *RST: OFF |

15.13.1.4 Modulation Settings

| | |
|-----------------------------------------|-----|
| WGENerator:MODulation[:ENABLE]..... | 513 |
| WGENerator:MODulation:FUNCTion..... | 513 |
| WGENerator:MODulation:TYPE..... | 513 |
| WGENerator:MODulation:AM:FREQuency..... | 513 |
| WGENerator:MODulation:AM:DEPTH..... | 514 |

| | |
|-------------------------------------------|-----|
| WGENerator:MODulation:FM:FREQuency..... | 514 |
| WGENerator:MODulation:FM:DEVIation..... | 514 |
| WGENerator:MODulation:ASK:FREQuency..... | 514 |
| WGENerator:MODulation:ASK:DEPTH..... | 514 |
| WGENerator:MODulation:FSK:HFREquency..... | 514 |
| WGENerator:MODulation:FSK:RATE..... | 515 |
| WGENerator:MODulation:RAMP:POLarity..... | 515 |

WGENerator:MODulation[:ENABLE] <Enable>

Activates or deactivates modulation of the function generator output. To define the modulation function, see [WGENerator:MODulation:FUNCTion](#).

Parameters:

<Enable> ON | OFF

WGENerator:MODulation:FUNCTion <ModulationFunction>

Selects a function for the modulation.

Parameters:

<ModulationFunction> SINusiod | SQUare | TRIangle | RAMP

WGENerator:MODulation:TYPE <ModulationType>

Sets the modulation type, which defines how the carrier signal is modified.

Parameters:

<ModulationType> AM | FM | ASK | FSK

AM

Amplitude modulation. The amplitude of the carrier signal is varied according to the modulation signal.

FM

Frequency modulation. The frequency of the carrier signal is varied according to the modulation signal.

ASK

Amplitude shift keying (ASK) modulation. The amplitude switches between 100% and the [WGENerator:MODulation:ASK:DEPTH](#) amplitude with a defined modulating [WGENerator:MODulation:ASK:FREQuency](#).

FSK

Frequency shift keying (FSK) modulation. The signal frequency switches between the carrier frequency and the [WGENerator:MODulation:FSK:HFREquency](#) at a [WGENerator:MODulation:FSK:RATE](#).

WGENerator:MODulation:AM:FREQuency <Frequency>

Sets the frequency of the modulating waveform for AM modulation.

Parameters:
<Frequency>

WGENerator:MODulation:AM:DEPTH <ModulationDepth>

Sets the modulation depth, the percentage of the amplitude range that is used for AM modulation.

Parameters:
<ModulationDepth>

WGENerator:MODulation:FM:FREQUENCY <Frequency>

Sets the frequency of the modulating waveform for FM modulation.

Parameters:
<Frequency>

WGENerator:MODulation:FM:DEVIation <Deviation>

Sets the frequency deviation, the maximum difference between the FM modulated signal and the carrier signal.

Parameters:
<Deviation>

WGENerator:MODulation:ASK:FREQUENCY <Frequency>

Sets the frequency of the modulating waveform for ASK modulation.

Parameters:
<Frequency>

WGENerator:MODulation:ASK:DEPTH <ModulationDepth>

Sets the modulation depth, the percentage of the amplitude range that is used for ASK modulation.

Parameters:
<ModulationDepth>

WGENerator:MODulation:FSK:HFREQUENCY <HoppingFrequency>

Sets the second frequency of the FSK-modulated signal.

Parameters:
<HoppingFrequency> The range depends on the signal type:
Sinus: 100mHz - 25MHz
Sinc/Triangle/Ramp/Exponential: 100mHz - 1MHz
Rectangle/Pulse/Arbitrary: 100mHz - 10MHz

WGENerator:MODulation:FSK:RATE <Rate>

Sets the rate at which signal switches between the carrier frequency and the hopping frequency.

Parameters:

<Rate> Range: 0.1 to 1E6
 Default unit: Hz

WGENerator:MODulation:RAMP:POLarity <Polarity>

Sets the polarity for the ramp function for a modulation waveform.

Parameters:

<Polarity> POSitive | NEGative

15.13.1.5 Sweep Settings

| | |
|--------------------------------|-----|
| WGENerator:SWEep:FEND..... | 515 |
| WGENerator:SWEep:FSTart..... | 515 |
| WGENerator:SWEep:TIME..... | 515 |
| WGENerator:SWEep:TYPE..... | 515 |
| WGENerator:SWEep[:ENABLE]..... | 516 |

WGENerator:SWEep:FEND <StopFrequency>

Sets the stop frequency of the sweep signal.

Parameters:

<StopFrequency>

WGENerator:SWEep:FSTart <StartFrequency>

Sets the start frequency of the sweep signal.

Parameters:

<StartFrequency>

WGENerator:SWEep:TIME <SweepTime>

Sets the duration of the sweep.

Parameters:

<SweepTime>

WGENerator:SWEep:TYPE <SweepType>

Sets the type of the sweep, a linear, logarithmic or triangle-shaped change of the frequency.

Parameters:

<SweepType> LINear | LOGarithmic | TRIangle

WGENerator:SWEep[:ENABLE] <SweepEnable>

Enables or disables sweeping.

Parameters:

<SweepEnable> ON | OFF

15.13.2 Pattern Generator

| | |
|-----------------------------------------------------|-----|
| PGENerator:FUNcTion..... | 516 |
| PGENerator:PATtern:STATe..... | 517 |
| PGENerator:PATtern:STIME..... | 517 |
| PGENerator:PATtern:PERiod..... | 517 |
| PGENerator:PATtern:FREQuency..... | 518 |
| PGENerator:PATtern:ITIME..... | 518 |
| PGENerator:PATtern:BURSt:STATe..... | 518 |
| PGENerator:PATtern:BURSt:NCYCLE..... | 518 |
| PGENerator:PATtern:TRIGger:MODE..... | 519 |
| PGENerator:PATtern:TRIGger:SINGLE..... | 519 |
| PGENerator:PATtern:TRIGger:EXTern:SLOPe..... | 519 |
| PGENerator:PATtern:ARBITrary:DATA[:SET]..... | 519 |
| PGENerator:PATtern:ARBITrary:DATA:APPend..... | 519 |
| PGENerator:PATtern:ARBITrary:DATA:APPend:BOR..... | 520 |
| PGENerator:PATtern:ARBITrary:DATA:APPend:BAND..... | 520 |
| PGENerator:PATtern:ARBITrary:DATA:APPend:INDEX..... | 520 |
| PGENerator:PATtern:ARBITrary:DATA:LENGth..... | 520 |
| PGENerator:PATtern:COUNter:FREQuency..... | 520 |
| PGENerator:PATtern:COUNter:DIRection..... | 521 |
| PGENerator:PATtern:SQUarewave:POLarity..... | 521 |
| PGENerator:PATtern:SQUarewave:DCYCLE..... | 521 |
| PGENerator:MANual:STATe<s>..... | 521 |

PGENerator:FUNcTion <PatternFunction>

Selects the pattern generator function.

Parameters:

<PatternFunction> SQUarewave | COUNter | ARBITrary | SPI | I2C | UART | CAN | LIN | MANual | I2S | TDM

SQUarewave

Square wave function (e.g. for manual probe compensation).

COUNter

Definition of a 4-bit wide counter pattern.

ARbitrary

Definition of a 4-bit wide and 2048 samples deep pattern.

SPI

SPI BUS signals for measurements without measurement object. Data rate 100 kBit/s, 250 kBit/s or 1 MBit/s.

I2C

I²C BUS signals for measurements without measurement object. Data rate 100 kBit/s, 400 kBit/s, 1 MBit/s or 3.4 MBit/s.

UART

UART BUS signals for measurements without measurement object. Data rate 9600 Bit/s, 115.2 kBit/s and 1 MBit/s.

CAN

CAN BUS signals for measurements without measurement object up to 50 MBit/s.

LIN

LIN BUS signals for measurements without measurement object up to 50 MBit/s.

MANual

Manual pattern mode.

I2S

Audio-I2S BUS signal.

TDM

Audio-TDM BUS signal.

*RST: SQUarewave

PGENERator:PATTERn:STATe <State>

Activates or deactivates the pattern output.

Parameters:

<State> ON | OFF
*RST: ON

PGENERator:PATTERn:STIME <SampleTime>

Sets the time at which each sample is applied for the pattern generator function.

Parameters:

<SampleTime> Numeric value
Range: 2.000E-08 to 4.200E+01
*RST: 2.000E-08
Default unit: s

PGENERator:PATTERn:PERiod <PatternPeriod>

Defines the period of the pattern generator function.

Parameters:

<PatternPeriod> Numeric value (Period = Pattern length * Bit time)
 Range: MIN 1 Sample * 20ns = 20ns to MAX 2048 Sam-
 ples * 42s = 10416s (approx. 2.89h)
 *RST: 2.000E-06
 Default unit: s

PGENERator:PATtern:FREQuency <PatternFrequency>

Defines the frequency (period) value of the pattern generator function.

Parameters:

<PatternFrequency> Numeric value
 Default unit: Hz

PGENERator:PATtern:ITime <IdleTime>

Defines the idle time of the pattern generator function. The idle time can be only defined with activated BURST function.

Parameters:

<IdleTime> Numeric value
 Range: 2.000E-08 to 4.200000000000E+01
 *RST: 2.5000000000E-01
 Default unit: s

PGENERator:PATtern:BURSt:STATe <BurstState>

Turns the BURST function on or off.

Parameters:

<BurstState> ON | OFF
 *RST: OFF

PGENERator:PATtern:BURSt:NCYCLE <PatternCycles>

Defines the BURST pattern cycles. The cycles can be only defined with activated BURST function.

Parameters:

<PatternCycles> Numeric value
 Range: 1 to 4096
 *RST: 1

PGENERator:PATTern:TRIGger:MODE <TriggerMode>

Defines the arbitrary trigger mode of the pattern generator function.

Parameters:

<TriggerMode> CONTInuous | SINGle

CONTInuous

The CONT function (continuous trigger) issues the pattern continuously.

SINGle

If the SING setting is activated, the pattern is issued manually.

*RST: CONT

PGENERator:PATTern:TRIGger:SINGle

Manual output of a pattern (single trigger).

Usage: Event

PGENERator:PATTern:TRIGger:EXTern:SLOPe

Defines the slope of the external arbitrary pattern trigger.

Parameters:

<ExternSlope> POSitive | NEGative | EITHer

POSitive

Rising edge (rise).

NEGative

Falling edge (fall).

EITHer

Rising as well as the falling edge (both).

*RST: POSitive

PGENERator:PATTern:ARBItrary:DATA[:SET] <ArbitraryData>

Defines the arbitrary pattern.

Parameters:

<ArbitraryData> List of Values

Example: PGEN:PATT:ARB:DATA 0,1,1,1,2,0,3,1,4,0

PGENERator:PATTern:ARBItrary:DATA:APPend <AppendData>

Defines the arbitrary pattern.

Setting parameters:

<AppendData> List of Values

Example: PGEN:PATT:ARB:DATA:APP 4
From `index = n`, the oscilloscope appends a 4 in HEX to the pattern.

Usage: Setting only

PGENerator:PATTern:ARBITrary:DATA:APPend:BOR <AppendData>

From `index = n`, data will be integrated in existing pattern via OR combination.

Setting parameters:

<AppendData> List of Values

Usage: Setting only

PGENerator:PATTern:ARBITrary:DATA:APPend:BAND <AppendData>

From `index = n`, data will be integrated in existing pattern via AND combination.

Setting parameters:

<AppendData> List of Values

Usage: Setting only

PGENerator:PATTern:ARBITrary:DATA:APPend:INDex <AppendIndex>

Defines the index of the arbitrary pattern.

Parameters:

<AppendIndex> Numeric value

Example: PGEN:PATT:ARB:DATA:APP:IND 5
PGEN:PATT:ARB:DATA:APP 4
From `index = n`, a pattern length of 6 will be defined with last high bit 4.

PGENerator:PATTern:ARBITrary:DATA:LENGth <PatternLength>

Defines the arbitrary pattern length.

Parameters:

<PatternLength> Numeric value

Range: 1 to 2048

*RST: 1

PGENerator:PATTern:COUNter:FREQUency <Period>

Defines the frequency value of the pattern generator counter function. The user frequency always refers to the switching of the pattern condition. This results in square waveforms for individual pins.

| Pin | Frequency |
|-----|-----------|
| S0 | f/2 |
| S1 | f/4 |
| S2 | f/8 |
| S3 | f/16 |

Parameters:

<Period> Numeric value
 Range: 2.380952425301E-02 to 2.500000000000E+07
 *RST: 1.000000000000E+05
 Default unit: Hz

PGENERator:PATTERn:COUNTER:DIRection <CountDirection>

Sets the pattern generator counter direction.

Parameters:

<CountDirection> UPWard | DOWNward
 *RST: UPW

PGENERator:PATTERn:SQUarewave:POLarity <Polarity>

Defines the polarity of the pattern generator square wave function.

Parameters:

<Polarity> NORMal | INVerted
 *RST: NORM

PGENERator:PATTERn:SQUarewave:DCYCLE <DutyCycle>

Sets the duty cycle of the square wave function.

Parameters:

<DutyCycle> Numeric value
 Range: 1.00E+00 to 9.900E+01
 *RST: 5.000E+01
 Default unit: %

Example:

PGEN:PATT:SQU:DCYC 20
 Sets the duty cycle of the square wave function to 20%.

PGENERator:MANual:STATe<s> <State>

Selects the pins S0 to S3 manually and sets their states to high (H) or low (L).

| | |
|--------------------|-------------------------------------------------------------------------------------------------------------------|
| Suffix: | |
| <s> | 0..3
Pins S0 to S3 |
| Parameters: | |
| <State> | ON OFF
ON
Pin state is set to high (H).
OFF
Pin state is set to low (L).
*RST: OFF |
| Example: | PGEN:MAN:STAT2 ON
Sets the state of pin S2 to high (H). |

15.14 Status Reporting

15.14.1 STATus:OPERation Register

The commands of the `STATus:OPERation` subsystem control the status reporting structures of the `STATus:OPERation` register:

See also:

- [Chapter B.1, "Structure of a SCPI Status Register"](#), on page 542
- [Chapter B.3.3, "STATus:OPERation Register"](#), on page 547

The following commands are available:

| | |
|-------------------------------------------------|-----|
| <code>STATus:OPERation:CONDition?</code> | 522 |
| <code>STATus:OPERation:ENABLE</code> | 523 |
| <code>STATus:OPERation:NTRansition</code> | 523 |
| <code>STATus:OPERation:PTRansition</code> | 523 |
| <code>STATus:OPERation[:EVENT]?</code> | 523 |

STATus:OPERation:CONDition?

Returns the of the `CONDition` part of the operational status register.

Return values:

| | |
|-------------|-------------------------------------------------------------------------------------------------------------------------------------------------------------------------|
| <Condition> | Condition bits in decimal representation. <code>ALIGNment</code> (bit 0) , <code>SELFtest</code> (bit 1) , <code>AUToset</code> (bit 2), <code>WTRigger</code> (bit 3). |
| | Range: 1 to 65535 |
| | Increment: 1 |

Usage: Query only

STATus:OPERation:ENABLE <Enable>

Controls the ENABLE part of the STATus:OPERation register. The ENABLE defines which events in the EVENT part of the status register are forwarded to the OPERATION summary bit (bit 7) of the status byte. The status byte can be used to create a service request.

Parameters:

<Enable> Range: 1 to 65535
 Increment: 1

Example:

STATus:OPERation:ENABLE 5

The ALIGNment event (bit 0) and AUToset event (bit 2) are forwarded to the OPERATION summary bit of the status byte.

STATus:OPERation:NTRansition <NegativeTransition>**Parameters:**

<NegativeTransition> Range: 1 to 65535
 Increment: 1

STATus:OPERation:PTRansition <PositiveTransition>**Parameters:**

<PositiveTransition> Range: 1 to 65535
 Increment: 1

STATus:OPERation[:EVENT]?**Return values:**

<Event> Range: 1 to 65535
 Increment: 1

Usage: Query only

15.14.2 STATus:QUEStionable Registers

The commands of the STATus:QUEStionable subsystem control the status reporting structures of the STATus:QUEStionable registers:

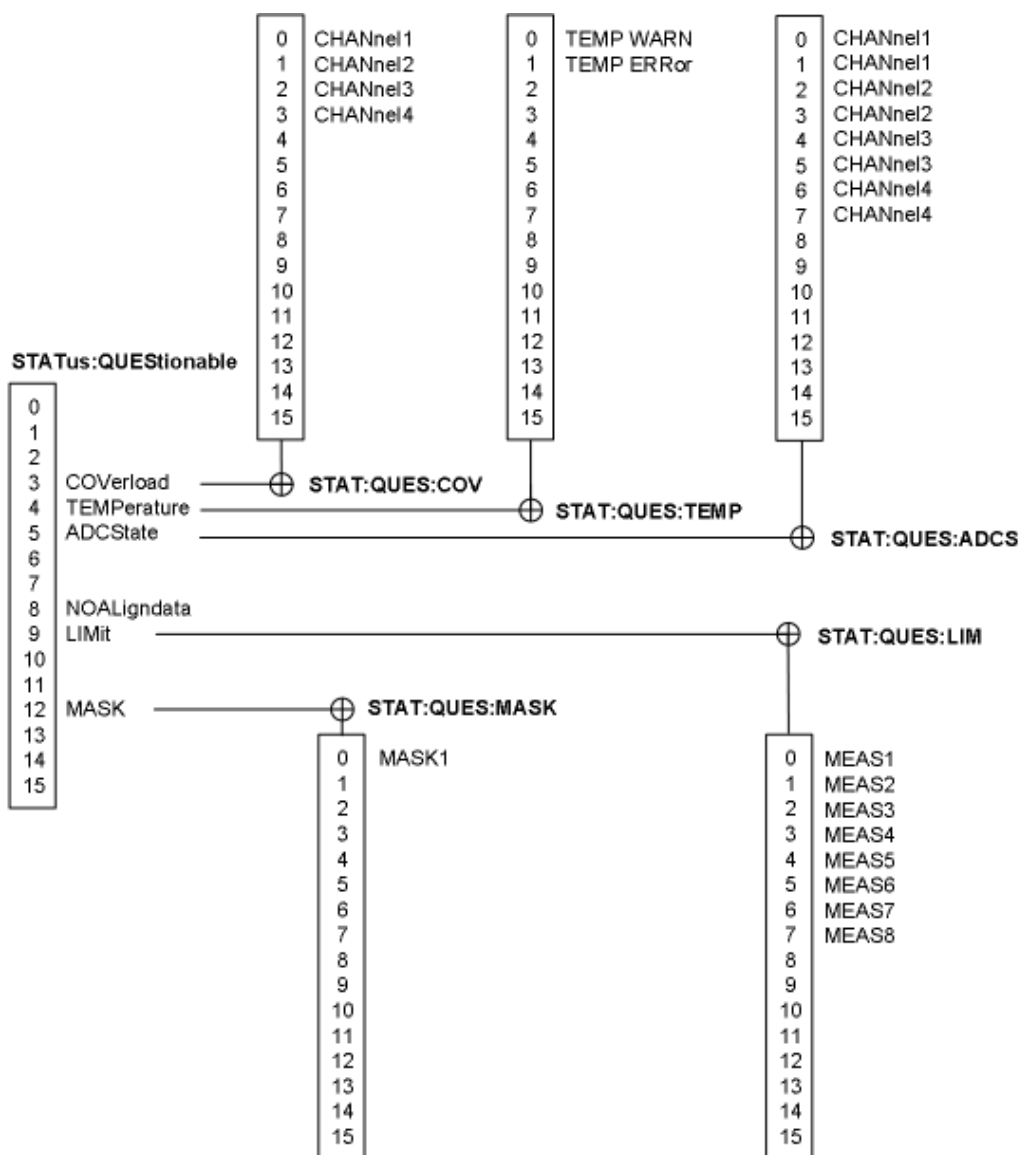

Figure 15-1: Structure of the STATUS:QUESTIONABLE register

See also:

- Chapter B.1, "Structure of a SCPI Status Register", on page 542
- Chapter B.3.4, "STATUS:QUESTIONABLE Register", on page 547

The following commands are available:

| | |
|----------------------------------------------------------------|-----|
| STATUS:PRESet | 525 |
| STATUS:QUESTIONABLE:CONDition? | 525 |
| STATUS:QUESTIONABLE:COVerload:CONDition? | 525 |
| STATUS:QUESTIONABLE:ADCState:CONDition? | 525 |
| STATUS:QUESTIONABLE:LIMit:CONDition? | 525 |
| STATUS:QUESTIONABLE:MASK:CONDition? | 525 |
| STATUS:QUESTIONABLE:ENABLE | 525 |
| STATUS:QUESTIONABLE:COVerload:ENABLE | 525 |

| | |
|------------------------------------------------|-----|
| STATus:QUESTionable:ADCState:ENABle..... | 525 |
| STATus:QUESTionable:LIMit:ENABle..... | 526 |
| STATus:QUESTionable:MASK:ENABle..... | 526 |
| STATus:QUESTionable[:EVENT]? | 526 |
| STATus:QUESTionable:COVerload[:EVENT]? | 526 |
| STATus:QUESTionable:ADCState[:EVENT]? | 526 |
| STATus:QUESTionable:LIMit[:EVENT]? | 526 |
| STATus:QUESTionable:MASK[:EVENT]? | 526 |
| STATus:QUESTionable:NTRansition..... | 526 |
| STATus:QUESTionable:COVerload:NTRansition..... | 526 |
| STATus:QUESTionable:ADCState:NTRansition..... | 526 |
| STATus:QUESTionable:LIMit:NTRansition..... | 526 |
| STATus:QUESTionable:MASK:NTRansition..... | 526 |
| STATus:QUESTionable:PTRansition..... | 527 |
| STATus:QUESTionable:COVerload:PTRansition..... | 527 |
| STATus:QUESTionable:ADCState:PTRansition..... | 527 |
| STATus:QUESTionable:LIMit:PTRansition..... | 527 |
| STATus:QUESTionable:MASK:PTRansition..... | 527 |

STATus:PRESet

Resets all STATUS:QUESTIONABLE registers.

Usage: Event

STATus:QUESTionable:CONDition?**STATus:QUESTionable:COVerload:CONDition?****STATus:QUESTionable:ADCState:CONDition?****STATus:QUESTionable:LIMit:CONDition?****STATus:QUESTionable:MASK:CONDition?**

Returns the contents of the CONDition part of the status register to check for questionable instrument or measurement states. Reading the CONDition registers does not delete the contents.

Return values:

<Condition> Condition bits in decimal representation

Range: 0 to 65535

Increment: 1

Usage: Query only

STATus:QUESTionable:ENABle <Enable>

STATus:QUESTionable:COVerload:ENABle <Enable>

STATus:QUESTionable:ADCState:ENABle <Enable>

STATus:QUESTIONable:LIMit:ENABle <Enable>

STATus:QUESTIONable:MASK:ENABle <Enable>

Sets the ENABle part that allows true conditions in the EVENT part to be reported in the summary bit. If a bit is set to 1 in the enable part and its associated event bit transitions to true, a positive transition occurs in the summary bit and is reported to the next higher level.

Parameters:

<Enable> Bit mask in decimal representation
 Range: 0 to 65535
 Increment: 1

Example:

STATus:QUESTIONable:MASK:ENABle 24
 Set bits no. 3 and 4 of the STATus:QUESTIONable:MASK:ENABle register part: $24 = 8 + 16 = 2^3 + 2^4$

STATus:QUESTIONable[:EVENT]?

STATus:QUESTIONable:COVERload[:EVENT]?

STATus:QUESTIONable:ADCState[:EVENT]?

STATus:QUESTIONable:LIMit[:EVENT]?

STATus:QUESTIONable:MASK[:EVENT]?

Returns the contents of the EVENT part of the status register to check whether an event has occurred since the last reading. Reading an EVENT register deletes its contents.

Return values:

<Event> Event bits in decimal representation
 Range: 0 to 65535
 Increment: 1

Usage: Query only

STATus:QUESTIONable:NTRansition <NegativeTransition>

STATus:QUESTIONable:COVERload:NTRansition <NegativeTransition>

STATus:QUESTIONable:ADCState:NTRansition <NegativeTransition>

STATus:QUESTIONable:LIMit:NTRansition <NegativeTransition>

STATus:QUESTIONable:MASK:NTRansition <NegativeTransition>

Sets the negative transition filter. If a bit is set, a 1 to 0 transition in the corresponding bit of the condition register causes a 1 to be written in the corresponding bit of the event register.

Parameters:

<NegativeTransition> Bit mask in decimal representation
 Range: 0 to 65535
 Increment: 1

Example:

STATus:QUESTIONable:MASK:NTRansition 24
 Set bits no. 3 and 4 of the STATus:QUESTIONable:MASK:NTRansition register part: $24 = 8 + 16 = 2^3 + 2^4$

STATus:QUESTionable:PTRansition <PositiveTransition>
STATus:QUESTionable:COVerload:PTRansition <PositiveTransition>
STATus:QUESTionable:ADCState:PTRansition <PositiveTransition>
STATus:QUESTionable:LIMit:PTRansition <PositiveTransition>
STATus:QUESTionable:MASK:PTRansition <PositiveTransition>

Sets the positive transition filter. If a bit is set, a 0 to 1 transition in the corresponding bit of the condition register causes a 1 to be written in the corresponding bit of the event register.

Parameters:

<PositiveTransition> Bit mask in decimal representation
Range: 0 to 65535
Increment: 1

Example:

STATus:QUESTionable:MASK:PTRansition 24
Set bits no. 3 and 4 of the STATus:QUESTionable:MASK:PTRansition register part: $24 = 8 + 16 = 2^3 + 2^4$

16 Maintenance

The instrument does not need a periodic maintenance. Only the cleaning of the instrument is essential.

To protect the front panel and to transport the instrument to another workplace safely and easily, several accessories are provided. The type designations and order numbers are listed in the data sheet.

In case of instrument damage, contact the nearest Rohde & Schwarz service center. A list of all service centers is available on www.services.rohde-schwarz.com.

The addresses of Rohde & Schwarz support centers can be found at www.customer-support.rohde-schwarz.com.

16.1 Cleaning

1. Clean the outside of the instrument using a soft, dry, lint-free dust cloth.

Note: Do not use any liquids for cleaning. Cleaning agents, solvents (thinners, acetone), acids and bases can damage the front panel labeling, plastic parts and display.

2. Check and clean the fans regularly to ensure that they always operate properly.
3. Clean the touchscreen as follows:
 - a) Apply a small amount of standard screen cleaner to a soft cloth.
 - b) Wipe the screen gently with the moist, but not wet, cloth.
 - c) If necessary, remove any excess moisture with a dry, soft cloth.

16.2 Storing and Packing

The storage temperature range of the instrument is given in the data sheet. If the instrument is to be stored for a longer period of time, it must be protected against dust.

Repack the instrument as it was originally packed when transporting or shipping. The two protective foam plastic parts prevent the control elements and connectors from being damaged. The antistatic packing foil avoids any undesired electrostatic charging to occur.

If you do not use the original packaging, use a sturdy cardboard box of suitable size and provide for sufficient padding to prevent the instrument from slipping inside the package. Wrap antistatic packing foil around the instrument to protect it from electrostatic charging.

16.3 Replacing the Fuse

The instrument is protected by a fuse. You can find it on the rear panel between the main power switch and AC power supply.

Type of fuse: Size 5x20 mm, 250V~, T2.5H (slow-blow), IEC60127-2/5

WARNING

Risk of electric shock

The fuse is part of the main power supply. Therefore, handling the fuse while power is on can lead to electric shock. Before opening the fuse holder, make sure that the instrument is switched off and disconnected from all power supplies.

Always use fuses supplied by Rohde & Schwarz as spare parts, or fuses of the same type and rating.

1. Pull the fuse holder out of its slot on the rear panel.
2. Exchange the fuse.
3. Insert the fuse holder carefully back in its slot until it latches.

16.4 Data Security

If you have to send the instrument to the service, or if the instrument is used in a secured environment, consider the document "Instrument Security Procedures" that is available on the R&S RTB2000 internet web page.

You can delete all current instrument configuration data and user data with "Setup" menu > "Secure Erase".

Annex

A Remote Control - Basics

A.1 SCPI Command Structure

SCPI commands consist of a header and, in most cases, one or more parameters. The header and the parameters are separated by a "white space" (ASCII code 0 to 9, 11 to 32 decimal, e.g. blank). The headers may consist of several mnemonics (keywords). Queries are formed by appending a question mark directly to the header.

The commands can be either device-specific or device-independent (common commands). Common and device-specific commands differ in their syntax.

A.1.1 Syntax for Common Commands

Common (= device-independent) commands consist of a header preceded by an asterisk (*), and possibly one or more parameters.

Table A-1: Examples of common commands

| | | |
|-------|----------------------|-----------------------------------------------------|
| *RST | RESET | Resets the instrument. |
| *ESE | EVENT STATUS ENABLE | Sets the bits of the event status enable registers. |
| *ESR? | EVENT STATUS QUERY | Queries the contents of the event status register. |
| *IDN? | IDENTIFICATION QUERY | Queries the instrument identification string. |

A.1.2 Syntax for Device-Specific Commands



Not all commands used in the following examples are necessarily implemented in the instrument. For demonstration purposes only, assume the existence of the following commands for this section:

- DISPLAY[:WINDow<1...4>]:MAXimize <Boolean>
- FORMat:READings:DATA <type>[,<length>]
- HCOpy:DEvice:COLor <Boolean>
- HCOpy:DEvice:CMAP:COLor:RGB <red>,<green>,<blue>
- HCOpy[:IMMediate]
- HCOpy:ITEM:ALL
- HCOpy:ITEM:LABel <string>
- HCOpy:PAGE:DIMensions:QUADrant [<N>]
- HCOpy:PAGE:ORientation LANDscape | PORTrait
- HCOpy:PAGE:SCALE <numeric value>
- MMEMoRY:CoPY <file_source>,<file_destination>
- SENSE:BANDwidth|BWIDth[:RESolution] <numeric_value>
- SENSE:FREQuency:STOP <numeric value>
- SENSE:LIST:FREQuency <numeric_value>{,<numeric_value>}

- [Long and short form](#)..... 531
- [Numeric Suffixes](#)..... 531
- [Optional Mnemonics](#)..... 532

A.1.2.1 Long and short form

The mnemonics feature a long form and a short form. The short form is marked by upper case letters, the long form corresponds to the complete word. Either the short form or the long form can be entered; other abbreviations are not permitted.

Example:

HCOpy:DEvice:COLor ON is equivalent to HCOP:DEV:COL ON.



Case-insensitivity

Upper case and lower case notation only serves to distinguish the two forms in the manual, the instrument itself is case-insensitive.

A.1.2.2 Numeric Suffixes

If a command can be applied to multiple instances of an object, e.g. specific channels or sources, the required instances can be specified by a suffix added to the command. Numeric suffixes are indicated by angular brackets (<1...4>, <n>, <i>) and are replaced

by a single value in the command. Entries without a suffix are interpreted as having the suffix 1.

Example:

Definition: `HCOPY:PAGE:DIMensions:QUADrant [<N>]`

Command: `HCOP:PAGE:DIM:QUAD2`

This command refers to the quadrant 2.



Different numbering in remote control

For remote control, the suffix may differ from the number of the corresponding selection used in manual operation. SCPI prescribes that suffix counting starts with 1. Suffix 1 is the default state and used when no specific suffix is specified.

Some standards define a fixed numbering, starting with 0. If the numbering differs in manual operation and remote control, it is indicated for the corresponding command.

A.1.2.3 Optional Mnemonics

Some command systems permit certain mnemonics to be inserted into the header or omitted. These mnemonics are marked by square brackets in the description. The instrument must recognize the long command to comply with the SCPI standard. Some commands are considerably shortened by these optional mnemonics.

Example:

Definition: `HCOPY[:IMMEDIATE]`

Command: `HCOP:IMM` is equivalent to `HCOP`



Optional mnemonics with numeric suffixes

Do not omit an optional mnemonic if it includes a numeric suffix that is relevant for the effect of the command.

Example:

Definition: `DISPlay[:WINDow<1...4>]:MAXimize <Boolean>`

Command: `DISP:MAX ON` refers to window 1.

In order to refer to a window other than 1, you must include the optional `WINDow` parameter with the suffix for the required window.

`DISP:WIND2:MAX ON` refers to window 2.

A.1.3 SCPI Parameters

Many commands are supplemented by a parameter or a list of parameters. The parameters must be separated from the header by a "white space" (ASCII code 0 to 9, 11 to 32 decimal, e.g. blank).

The parameters required for each command and the allowed range of values are specified in the command description.

Allowed parameters are:

| | |
|------------------------------------------------|-----|
| • Numeric Values | 533 |
| • Special Numeric Values | 533 |
| • Boolean Parameters | 534 |
| • Text Parameters | 534 |
| • Character Strings | 535 |
| • Block Data | 535 |

A.1.3.1 Numeric Values

Numeric values can be entered in any form, i.e. with sign, decimal point and exponent. Values exceeding the resolution of the instrument are rounded up or down. The mantissa may comprise up to 255 characters, the exponent must lie inside the value range -32000 to 32000. The exponent is introduced by an "E" or "e". Entry of the exponent alone is not allowed.

Example:

```
SENS:FREQ:STOP 1500000 = SENS:FREQ:STOP 1.5E6
```

Units

For physical quantities, the unit can be entered. If the unit is missing, the basic unit is used. Allowed unit prefixes are:

- G (giga)
- MA (mega), MOHM, MHZ
- K (kilo)
- M (milli)
- U (micro)
- N (nano)

Example:

```
SENSe:FREQ:STOP 1.5GHz = SENSe:FREQ:STOP 1.5E9
```

Some settings allow relative values to be stated in percent. According to SCPI, this unit is represented by the PCT string.

Example:

```
HCOP:PAGE:SCAL 90PCT
```

A.1.3.2 Special Numeric Values

The following mnemonics are special numeric values. In the response to a query, the numeric value is provided.

- **MIN and MAX:** denote the minimum and maximum value.
- **DEF:** denotes a preset value which has been stored in the EPROM. This value conforms to the default setting, as it is called by the *RST command.
- **NAN:** Not A Number (NAN) represents the value 9.91E37. NAN is only sent as a instrument response. This value is not defined. Possible causes are the division of zero by zero, the subtraction of infinite from infinite and the representation of missing values.

Example:

Setting command: `SENSe:LIST:FREQ MAXimum`

Query: `SENS:LIST:FREQ?`

Response: `3.5E9`

**Queries for special numeric values**

The numeric values associated to `MAXimum`/`MINimum`/`DEFault` can be queried by adding the corresponding mnemonic after the quotation mark.

Example: `SENSe:LIST:FREQ? MAXimum`

Returns the maximum numeric value as a result.

A.1.3.3 Boolean Parameters

Boolean parameters represent two states. The "ON" state (logically true) is represented by "ON" or a numeric value 1. The "OFF" state (logically untrue) is represented by "OFF" or the numeric value 0. The numeric values are provided as the response for a query.

Example:

Setting command: `HCOPY:DEV:COL ON`

Query: `HCOPY:DEV:COL?`

Response: `1`

A.1.3.4 Text Parameters

Text parameters observe the syntactic rules for mnemonics, i.e. they can be entered using a short or long form. Like any parameter, they have to be separated from the header by a white space. In the response to a query, the short form of the text is provided.

Example:

Setting command: `HCOPY:PAGE:ORIENTATION LANDscape`

Query: `HCOP:PAGE:ORI?`

Response: `LAND`

A.1.3.5 Character Strings

Strings must always be entered in quotation marks (' or ").

Example:

```
HCOP:ITEM:LABel "Test1"
```

```
HCOP:ITEM:LABel 'Test1'
```

A.1.3.6 Block Data

Block data is a format which is suitable for the transmission of large amounts of data. For example, a command using a block data parameter has the following structure:

```
FORMat:READings:DATA #45168xxxxxxxx
```

The ASCII character # introduces the data block. The next number indicates how many of the following digits describe the length of the data block. In the example the 4 following digits indicate the length to be 5168 bytes. The data bytes follow. During the transmission of these data bytes all end or other control signs are ignored until all bytes are transmitted.

#0 specifies a data block of indefinite length. The use of the indefinite format requires a `NL^END` message to terminate the data block. This format is useful when the length of the transmission is not known or if speed or other considerations prevent segmentation of the data into blocks of definite length.

A.1.4 Overview of Syntax Elements

The following tables provide an overview of the syntax elements and special characters.

Table A-2: Syntax elements

| | |
|-----|---------------------------------------------------------------------------------------------------------------------------------------------------------------------------------------------------------------------|
| : | The colon separates the mnemonics of a command. |
| ; | The semicolon separates two commands of a command line. It does not alter the path. |
| , | The comma separates several parameters of a command. |
| ? | The question mark forms a query. |
| * | The asterisk marks a common command. |
| ' ' | Quotation marks introduce a string and terminate it (both single and double quotation marks are possible). |
| # | The hash symbol introduces binary, octal, hexadecimal and block data. <ul style="list-style-type: none"> • Binary: #B10110 • Octal: #O7612 • Hexa: #HF3A7 • Block: #21312 |
| | A "white space" (ASCII-Code 0 to 9, 11 to 32 decimal, e.g. blank) separates the header from the parameters. |

Table A-3: Special characters

| | |
|-----|-----------------------------------------------------------------------------------------------------------------------------------------------------------------------------------------------------------------------------------------------------------------------------------------------------------------------------------------------------------------------------------------------------------------------------------------------------------------------------------------------------------------------------------------------------------------------------------------------------------------------------------------------------------------------------------------------------------------------------------------------------------------------------------------------------------------------------------------------------------------------------------------------------------------------------------------------------------------------------------------------------------------------------------------------------------------------------------------------------|
| | <p>Parameters</p> <p>A vertical stroke in parameter definitions indicates alternative possibilities in the sense of "or". The effect of the command differs, depending on which parameter is used.</p> <p>Example:</p> <p>Definition: <code>HCOPY:PAGE:ORIENTATION LANDscape PORTRait</code></p> <p>Command <code>HCOP:PAGE:ORI LAND</code> specifies landscape orientation</p> <p>Command <code>HCOP:PAGE:ORI PORT</code> specifies portrait orientation</p> <p>Mnemonics</p> <p>A selection of mnemonics with an identical effect exists for several commands. These mnemonics are indicated in the same line; they are separated by a vertical stroke. Only one of these mnemonics needs to be included in the header of the command. The effect of the command is independent of which of the mnemonics is used.</p> <p>Example:</p> <p>Definition: <code>SENSE:BANDwidth BWIDTH[:RESolution] <numeric_value></code></p> <p>The two following commands with identical meaning can be created:</p> <p><code>SENS:BAND:RES 1</code></p> <p><code>SENS:BWID:RES 1</code></p> |
| [] | <p>Mnemonics in square brackets are optional and may be inserted into the header or omitted.</p> <p>Example: <code>HCOPY[:IMMEDIATE]</code></p> <p><code>HCOP:IMM</code> is equivalent to <code>HCOP</code></p> |
| { } | <p>Parameters in curly brackets are optional and can be inserted once or several times, or omitted.</p> <p>Example: <code>SENSE:LIST:FREQUENCY <numeric_value>{,<numeric_value>}</code></p> <p>The following are valid commands:</p> <p><code>SENS:LIST:FREQ 10</code></p> <p><code>SENS:LIST:FREQ 10,20</code></p> <p><code>SENS:LIST:FREQ 10,20,30,40</code></p> |

A.1.5 Structure of a Command Line

A command line may consist of one or several commands. It is terminated by one of the following:

- <New Line>
- <New Line> with EOI
- EOI together with the last data byte

Several commands in a command line must be separated by a semicolon ";".

Example:

```
MMEM:COPY "Test1","MeasurementXY";:HCOP:ITEM ALL
```

This command line contains two commands. The first command belongs to the MMEM system, the second command belongs to the HCOP system. If the next command belongs to a different command system, the semicolon is followed by a colon.

Example:

```
HCOP:ITEM ALL;:HCOP:IMM
```

This command line contains two commands. Both commands are part of the `HCOP` command system, i.e. they have one level in common.

If the successive commands belong to the same system, having one or several levels in common, the command line can be abbreviated. When abbreviating the command line, the second command begins with the level below `HCOP`. The colon after the semi-colon is omitted. The abbreviated form of the command line reads as follows:

```
HCOP:ITEM ALL;IMM
```

Example:

```
HCOP:ITEM ALL
```

```
HCOP:IMM
```

A new command line always begins with the complete path.

A.1.6 Responses to Queries

A query is defined for each setting command unless explicitly specified otherwise. It is formed by adding a question mark to the associated setting command. According to SCPI, the responses to queries are partly subject to stricter rules than in standard IEEE 488.2.

- The requested parameter is transmitted without a header.
Example: `HCOP:PAGE:ORI?`, **Response:** `LAND`
- Maximum values, minimum values and all other quantities that are requested via a special text parameter are returned as numeric values.
Example: `SENSe:FREQuency:STOP? MAX`, **Response:** `3.5E9`
- Numeric values are output without a unit. Physical quantities are referred to the basic units or to the units set using the `Unit` command. The response `3.5E9` in the previous example stands for 3.5 GHz.
- Truth values (Boolean values) are returned as 0 (for OFF) and 1 (for ON).
Example:
Setting command: `HCOPy:DEV:COL ON`
Query: `HCOPy:DEV:COL?`
Response: `1`
- Text (character data) is returned in a short form.
Example:
Setting command: `HCOPy:PAGE:ORIENTATION LANDscape`
Query: `HCOP:PAGE:ORI?`
Response: `LAND`
- Invalid numerical results
In some cases, particularly when a result consists of multiple numeric values, invalid values are returned as `9.91E37` (not a number).

A.2 Command Sequence and Synchronization

IEEE 488.2 defines a distinction between overlapped (asynchronous) and sequential commands:

- A sequential command finishes executing before the next command starts executing. Commands that are processed quickly are usually implemented as sequential commands.
- An overlapping or asynchronous command does not automatically finish executing before the next command starts executing. Usually, overlapping commands take longer to process and allow the program to do other tasks while being executed. If overlapping commands must be executed in a defined order, e.g. to avoid wrong measurement results, they must be serviced sequentially. This method is called synchronization between the controller and the instrument.



As a rule, send commands and queries in different program messages, i.e. in separate command lines.

Do not combine queries with commands that affect the queried value in one program message because the response to the query is not predictable.

The following messages always return correct results:

```
:CHAN:SCAL 0.01;POS 1
```

```
:CHAN:SCAL?
```

Result: 0.01 (10 mV/div)

Reason: Setting commands within one command line, even though they are implemented as sequential commands, are not necessarily serviced in the order in which they have been received.

For further information, refer to:

- rohde-schwarz.com/rckb: Rohde & Schwarz web page that provides information on instrument drivers and remote control.
- "Automatic Measurement Control - A tutorial on SCPI and IEEE 488.2" from John M. Pieper (R&S order number 0002.3536.00). The book offers detailed information on concepts and definitions of SCPI.

A.2.1 Preventing Overlapping Execution

To prevent an overlapping execution of commands, one of the commands `*OPC`, `*OPC?` or `*WAI` can be used. All three commands cause a certain action only to be carried out after the hardware has been set. The controller can be forced to wait for the corresponding action to occur.

Table A-4: Synchronization using *OPC, *OPC? and *WAI

| Command | Action | Programming the controller |
|---------|------------------------------------------------------------------------------------------------------|---------------------------------------------------------------------------------------------------------------------------------------------------------|
| *OPC | Sets the Operation Complete bit in the ESR after all previous commands have been executed. | <ul style="list-style-type: none"> Setting bit 0 in the ESE Setting bit 5 in the SRE Waiting for service request (SRQ) |
| *OPC? | Stops command processing until 1 is returned. This occurs when all pending operations are completed. | Send *OPC? directly after the command whose processing must be terminated before other commands can be executed. |
| *WAI | Stops further command processing until all commands sent before *WAI have been executed. | Send *WAI directly after the command whose processing must be terminated before other commands are executed. |

Command synchronization using *WAI or *OPC? is a good choice if the overlapped command takes only little time to process. The two synchronization commands simply block overlapped execution of the command. Append the synchronization command to the overlapping command, for example:

```
SINGLE; *OPC?
```

For time consuming overlapped commands, you can allow the controller or the instrument to do other useful work while waiting for command execution. Use one of the following methods:

*OPC with a service request

1. Set the OPC mask bit (bit no. 0) in the ESE: *ESE 1
2. Set bit no. 5 in the SRE: *SRE 32 to enable ESB service request.
3. Send the overlapped command with *OPC .
4. Wait for a service request.

The service request indicates that the overlapped command has finished.

*OPC? with a service request

1. Set bit no. 4 in the SRE: *SRE 16 to enable MAV service request.
2. Send the overlapped command with *OPC?.
3. Wait for a service request.

The service request indicates that the overlapped command has finished.

Event status register (ESE)

1. Set the OPC mask bit (bit no. 0) in the ESE: *ESE 1
2. Send the overlapped command without *OPC, *OPC? or *WAI.

3. Poll the operation complete state periodically (with a timer) using the sequence:
*OPC; *ESR?

A return value (LSB) of 1 indicates that the overlapped command has finished.

A.3 Messages

A.3.1 Instrument Messages

Instrument messages are employed in the same way for all interfaces, if not indicated otherwise in the description.

There are different types of instrument messages, depending on the direction they are sent:

- Commands
- Instrument responses

Structure and syntax of the instrument messages are described in [Chapter A.1, "SCPI Command Structure"](#), on page 530.

Commands

Commands (program messages) are messages that the controller sends to the instrument. They operate the instrument functions and request information. The commands are subdivided according to two criteria:

- According to the effect on the instrument:
 - **Setting commands** cause instrument settings such as a reset of the instrument or setting the frequency.
 - **Queries** cause data to be provided for remote control, e.g. for identification of the instrument or polling a parameter value. Queries are formed by directly appending a question mark to the command header.
- According to their definition in standards:
 - **Common commands**: their function and syntax are precisely defined in standard IEEE 488.2. They are employed identically on all instruments (if implemented). They refer to functions such as management of the standardized status registers, reset and self-test.
 - **Instrument control commands** refer to functions depending on the features of the instrument such as frequency settings. Many of these commands have also been standardized by the SCPI committee. These commands are marked as "SCPI compliant" in the command reference chapters. Commands without this SCPI label are device-specific, however, their syntax follows SCPI rules as permitted by the standard.

Instrument responses

Instrument responses (response messages and service requests) are messages that the instrument sends to the controller after a query. They can contain measurement results, instrument settings and information on the instrument status.

A.3.2 LAN Interface Messages

In the LAN connection, the interface messages are called low-level control messages. These messages can be used to emulate interface messages of the GPIB bus.

| Command | Long term | Effect on the instrument |
|---------|-----------------------|----------------------------------------------------------------------------------------------------------------------------------------------------------------------|
| &ABO | Abort | Aborts processing of the commands just received. |
| &DCL | Device Clear | Aborts processing of the commands just received and sets the command processing software to a defined initial state. Does not change the instrument setting. |
| >L | Go to Local | Transition to the "local" state (manual control). (The instrument automatically returns to remote state when a remote command is sent UNLESS &NREN was sent before.) |
| >R | Go to Remote | Enables automatic transition from local state to remote state by a subsequent remote command (after &NREN was sent). |
| &GET | Group Execute Trigger | Triggers a previously active instrument function (e.g. a sweep). The effect of the command is the same as with that of a pulse at the external trigger signal input. |
| &LLO | Local Lockout | Disables transition from remote control to manual control by means of the front panel keys. |
| &NREN | Not Remote Enable | Disables automatic transition from local state to remote state by a subsequent remote command. (To re-activate automatic transition use >R.) |
| &POL | Serial Poll | Starts a serial poll. |

B Remote Control - Status Reporting System

The status reporting system stores all information on the current operating state of the instrument, and on errors which have occurred. This information is stored in the status registers and in the error queue. Both can be queried via GPIB bus or LAN interface (STATus... commands).

B.1 Structure of a SCPI Status Register

Each standard SCPI register consists of 5 parts. Each part has a width of 16 bits and has different functions. The individual bits are independent of each other, i.e. each hardware status is assigned a bit number which is valid for all five parts. Bit 15 (the most significant bit) is set to zero for all parts. Thus the contents of the register parts can be processed by the controller as positive integers.

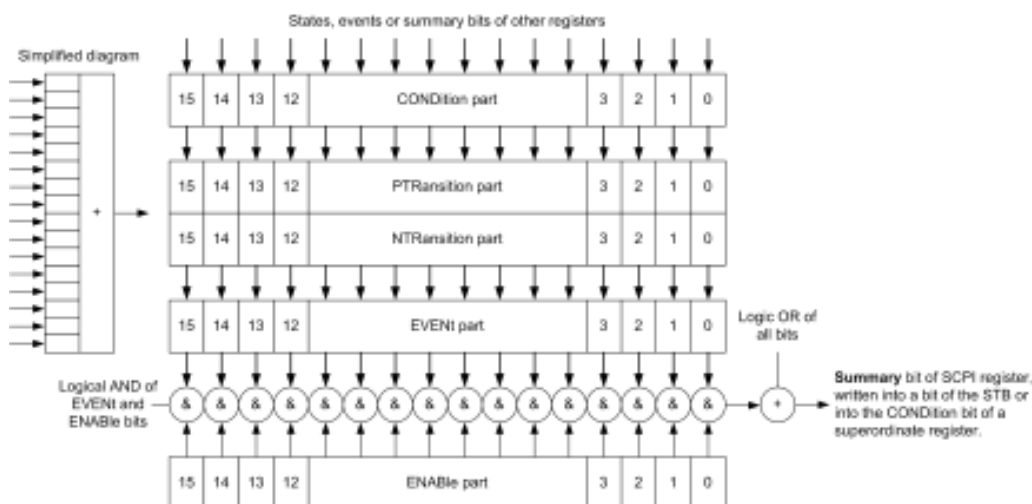

Figure B-1: The status-register model

Description of the five status register parts

The five parts of a SCPI register have different properties and functions:

- CONDition**
 The CONDition part is written into directly by the hardware or the sum bit of the next lower register. Its contents reflect the current instrument status. This register part can only be read, but not written into or cleared. Its contents are not affected by reading.
- PTRansition / NTRansition**
 The two transition register parts define which state transition of the CONDition part (none, 0 to 1, 1 to 0 or both) is stored in the EVENT part.
 The **Positive-TRansition** part acts as a transition filter. When a bit of the CONDition part is changed from 0 to 1, the associated PTR bit decides whether the EVENT bit is set to 1.

- PTR bit =1: the `EVENT` bit is set.
- PTR bit =0: the `EVENT` bit is not set.

This part can be written into and read as required. Its contents are not affected by reading.

The **Negative-Transition** part also acts as a transition filter. When a bit of the `CONDition` part is changed from 1 to 0, the associated `NTR` bit decides whether the `EVENT` bit is set to 1.

- NTR bit =1: the `EVENT` bit is set.
- NTR bit =0: the `EVENT` bit is not set.

This part can be written into and read as required. Its contents are not affected by reading.

- **EVENT**

The `EVENT` part indicates whether an event has occurred since the last reading, it is the "memory" of the condition part. It only indicates events passed on by the transition filters. It is permanently updated by the instrument. This part can only be read by the user. Reading the register clears it. This part is often equated with the entire register.

- **ENABLE**

The `ENABLE` part determines whether the associated `EVENT` bit contributes to the sum bit (see below). Each bit of the `EVENT` part is "ANDed" with the associated `ENABLE` bit (symbol '&'). The results of all logical operations of this part are passed on to the sum bit via an "OR" function (symbol '+').

`ENABLE` bit = 0: the associated `EVENT` bit does not contribute to the sum bit

`ENABLE` bit = 1: if the associated `EVENT` bit is "1", the sum bit is set to "1" as well.

This part can be written into and read by the user as required. Its contents are not affected by reading.

Sum bit

The sum bit is obtained from the `EVENT` and `ENABLE` part for each register. The result is then entered into a bit of the `CONDition` part of the higher-order register.

The instrument automatically generates the sum bit for each register. Thus an event can lead to a service request throughout all levels of the hierarchy.

B.2 Hierarchy of status registers

As shown in the following figure, the status information is of hierarchical structure.

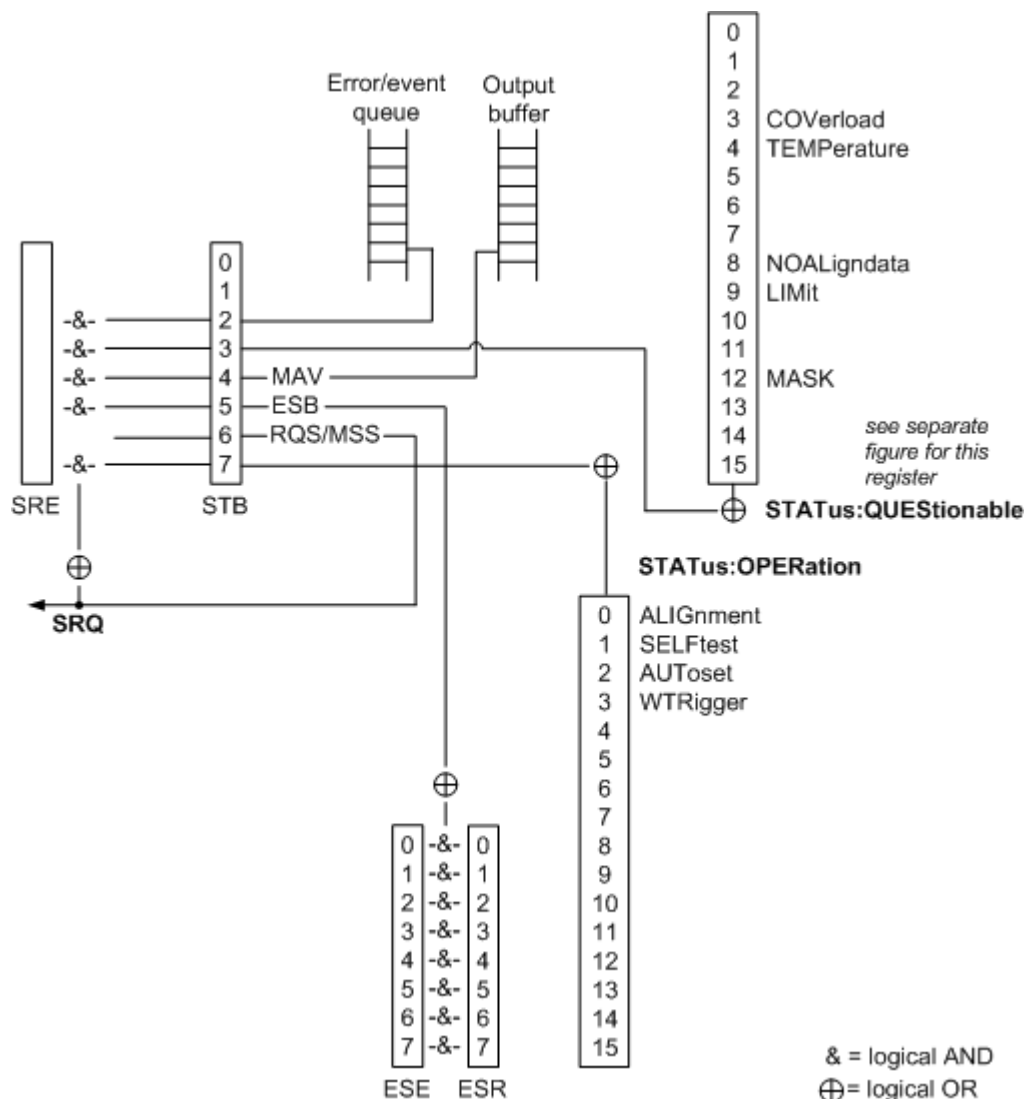

Figure B-2: Overview of the status registers hierarchy

- STB, SRE**
 The SStatus Byte (STB) register and its associated mask register Service Request Enable (SRE) form the highest level of the status reporting system. The STB provides a rough overview of the instrument status, collecting the information of the lower-level registers.
- ESR, SCPI registers**
 The STB receives its information from the following registers:
 - The Event Status Register (ESR) with the associated mask register standard Event Status Enable (ESE).
 - The STATUS:OPERation and STATUS:QUESTIONable registers which are defined by SCPI and contain detailed information on the instrument.
- Output buffer**

The output buffer contains the messages the instrument returns to the controller. It is not part of the status reporting system but determines the value of the `MAV` bit in the `STB` and thus is represented in the overview.

All status registers have the same internal structure.



SRE, ESE

The service request enable register `SRE` can be used as `ENABLE` part of the `STB` if the `STB` is structured according to SCPI. By analogy, the `ESE` can be used as the `ENABLE` part of the `ESR`.

B.3 Contents of the Status Registers

In the following sections, the contents of the status registers are described in more detail.

B.3.1 Status Byte (STB) and Service Request Enable Register (SRE)

The `Status Byte` (`STB`) is already defined in IEEE 488.2. It provides a rough overview of the instrument status by collecting the pieces of information of the lower registers. A special feature is that bit 6 acts as the sum bit of the remaining bits of the status byte.

The `STB` can thus be compared with the `CONDition` part of an SCPI register and assumes the highest level within the SCPI hierarchy.

The `STB` is read using the command `*STB?` or a serial poll.

The `Status Byte` (`STB`) is linked to the `Service Request Enable` (`SRE`) register. Each bit of the `STB` is assigned a bit in the `SRE`. Bit 6 of the `SRE` is ignored. If a bit is set in the `SRE` and the associated bit in the `STB` changes from 0 to 1, a service request (`SRQ`) is generated. The `SRE` can be set using the command `*SRE` and read using the command `*SRE?`.

Table B-1: Meaning of the bits used in the status byte

| Bit No. | Meaning |
|---------|--------------------------------------------------------------------------------------------------------------------------------------------------------------------------------------------------------------------------------------------------------------------------------------------------------------------------------------------------------------------------------------------------------------------------------------------------------|
| 0...1 | Not used |
| 2 | Error Queue not empty
The bit is set when an entry is made in the error queue. If this bit is enabled by the <code>SRE</code> , each entry of the error queue generates a service request. Thus an error can be recognized and specified in greater detail by polling the error queue. The poll provides an informative error message. This procedure is to be recommended since it considerably reduces the problems involved with remote control. |
| 3 | QUESTIONable status register summary bit
The bit is set if an <code>EVENT</code> bit is set in the <code>QUESTIONable</code> status register and the associated <code>ENABLE</code> bit is set to 1. A set bit indicates a questionable instrument status, which can be specified in greater detail by querying the <code>STATus:QUESTIONable</code> status register. |

| Bit No. | Meaning |
|---------|--------------------------------------------------------------------------------------------------------------------------------------------------------------------------------------------------------------------------------------------------------------------------------------------------------------------------------|
| 4 | MAV bit (message available)
The bit is set if a message is available in the output queue which can be read. This bit can be used to enable data to be automatically read from the instrument to the controller. |
| 5 | ESB bit
Sum bit of the event status register. It is set if one of the bits in the event status register is set and enabled in the event status enable register. Setting of this bit indicates a serious error which can be specified in greater detail by polling the event status register. |
| 6 | MSS bit (master status summary bit)
The bit is set if the instrument triggers a service request. This is the case if one of the other bits of this registers is set together with its mask bit in the service request enable register SRE. |
| 7 | STATUS:OPERation status register summary bit
The bit is set if an EVENT bit is set in the OPERATION status register and the associated ENABLE bit is set to 1. A set bit indicates that the instrument is just performing an action. The type of action can be determined by querying the STATUS:OPERation status register. |

B.3.2 Event Status Register (ESR) and Event Status Enable Register (ESE)

The ESR is defined in IEEE 488.2. It can be compared with the EVENT part of a SCPI register. The event status register can be read out using command *ESR?.

The ESE corresponds to the ENABLE part of a SCPI register. If a bit is set in the ESE and the associated bit in the ESR changes from 0 to 1, the ESB bit in the STB is set. The ESE register can be set using the command *ESE and read using the command *ESE?.

Table B-2: Meaning of the bits used in the event status register

| Bit No. | Meaning |
|---------|---------------------------------------------------------------------------------------------------------------------------------------------------------------------------------------------------------------------------------------------------------------------------------------------------|
| 0 | Operation Complete
This bit is set on receipt of the command *OPC exactly when all previous commands have been executed. |
| 1 | Not used |
| 2 | Query Error
This bit is set if either the controller wants to read data from the instrument without having sent a query, or if it does not fetch requested data and sends new instructions to the instrument instead. The cause is often a query which is faulty and hence cannot be executed. |
| 3 | Device-dependent Error
This bit is set if a device-dependent error occurs. An error message with a number between -300 and -399 or a positive error number, which denotes the error in greater detail, is entered into the error queue. |
| 4 | Execution Error
This bit is set if a received command is syntactically correct but cannot be performed for other reasons. An error message with a number between -200 and -300, which denotes the error in greater detail, is entered into the error queue. |

| Bit No. | Meaning |
|---------|---------------------------------------------------------------------------------------------------------------------------------------------------------------------------------------------------------------------------------------------|
| 5 | Command Error
This bit is set if a command is received, which is undefined or syntactically incorrect. An error message with a number between -100 and -200, which denotes the error in greater detail, is entered into the error queue. |
| 6 | User Request
This bit is set when the instrument is switched over to manual control. |
| 7 | Power On (supply voltage on)
This bit is set on switching on the instrument. |

B.3.3 STATUS:OPERation Register

In the `CONDition` part, this register contains information on which actions the instrument is being executing. In the `EVENT` part, it contains information on which actions the instrument has executed since the last reading. It can be read using the commands `STATUS:OPERation:CONDition?` or `STATUS:OPERation[:EVENT]?`.

See also: [Figure B-2](#)

The remote commands for the `STATUS:OPERation` register are described in [Chapter 15.14.1, "STATUS:OPERation Register"](#), on page 522.

Table B-3: Bits in the STATUS:OPERation register

| Bit No. | Meaning |
|---------|-----------------------------------------------------------------------------------------------------|
| 0 | <code>ALIGNment</code>
This bit is set as long as the instrument is performing a self alignment. |
| 1 | <code>SELFtest</code>
This bit is set while the selftest is running. |
| 2 | <code>AUTOset</code>
This bit is set while the instrument is performing an auto setup. |
| 3 | <code>WTRigger</code>
This bit is set while the instrument is waiting for the trigger. |
| 4 to 14 | Not used |
| 15 | This bit is always 0. |

B.3.4 STATUS:QUESTionable Register

This register contains information about indefinite states which may occur if the unit is operated without meeting the specifications. It can be read using the commands `STATUS:QUESTionable:CONDition?` on page 525 and `STATUS:QUESTionable[:EVENT]?` on page 526

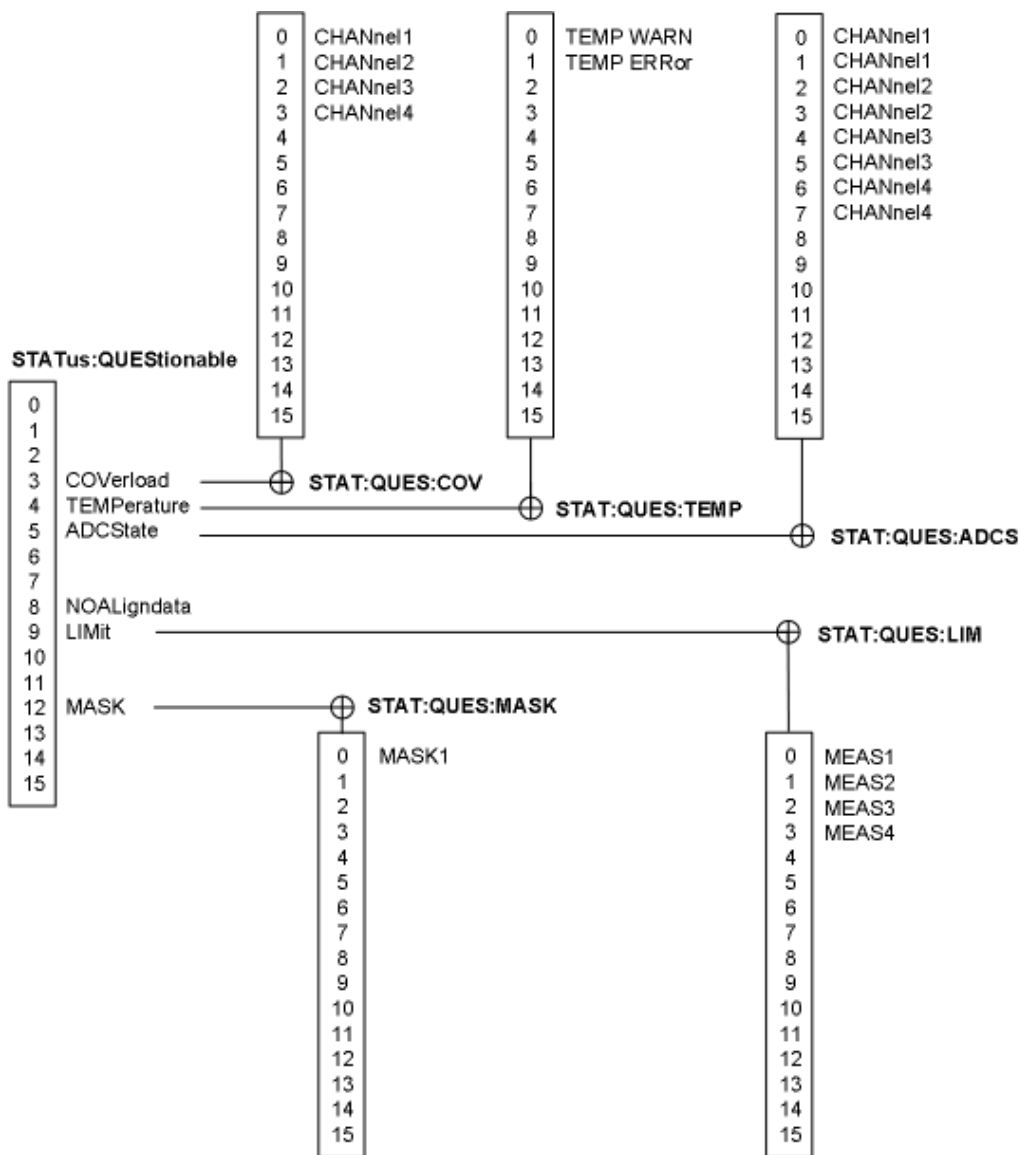

Figure B-3: Overview of the STATUS:QUESTIONABLE register

Table B-4: Bits in the STATUS:QUESTIONABLE register

| Bit No. | Meaning |
|---------|------------------------------------------------------------------------------------------------------------------------------------------------------|
| 0 to 2 | not used |
| 3 | COVerload
This bit is set if a questionable channel overload occurs (see Chapter B.3.4.1, "STATUS:QUESTIONABLE:COVerload register", on page 549). |
| 4 | TEMPerature
This bit is set if a questionable temperature occurs (see Chapter B.3.4.2, "STATUS:QUESTIONABLE:TEMPerature register", on page 549). |

| Bit No. | Meaning |
|----------|-------------------------------------------------------------------------------------------------------------------------------------------------------------------------------------------------------------------------|
| 5 | ADCState
The bit is set if the signal is clipped on the upper or lower edge of the screen -overflow of the ADC occurs (see Chapter B.3.4.3, "STATUS:QUESTIONable:ADCState Register" , on page 550). |
| 6 to 7 | Not used |
| 8 | NOALigndata
This bit is set if no alignment data is available - the instrument is uncalibrated. |
| 9 | LIMit
This bit is set if a limit value is violated (see Chapter B.3.4.4, "STATUS:QUESTIONable:LIMit register" , on page 550). |
| 10 to 11 | Not used |
| 12 | MASK
This bit is set if a mask value is violated (see Chapter B.3.4.5, "STATUS:QUESTIONable:MASK register" , on page 550 |
| 13 to 14 | Not used |
| 15 | This bit is always 0. |

B.3.4.1 STATUS:QUESTIONable:COVerload register

This register contains all information about overload of the channels. The bit is set if the assigned channel is overloaded.

Table B-5: Bits in the STATUS:QUESTIONable:COVerload register

| Bit No. | Meaning |
|---------|----------|
| 0 | CHANnel1 |
| 1 | CHANnel2 |
| 2 | CHANnel3 |
| 3 | CHANnel4 |

B.3.4.2 STATUS:QUESTIONable:TEMPerature register

This register contains information about the instrument's temperature.

Table B-6: Bits in the STATUS:QUESTIONable:TEMPerature register

| Bit No. | Meaning |
|---------|-----------------------------------------------------------------------------------------|
| 0 | TEMP WARN
This bit is set if a temperature warning on channel 1, 2, 3 or 4 occurred. |
| 1 | TEMP ERRor
This bit is set if a temperature error on channel 1, 2, 3 or 4 occurred. |

B.3.4.3 STATus:QUESTIONable:ADCState Register

This register contains all information about overflow of the ADC.

The bit is set if the assigned channel signal is clipped on the upper or lower edge of the screen. In this case, the signal does not fit in the range of the ADC and overflow occurs.

Table B-7: Bits in the STATus:QUESTIONable:ADCState register

| Bit No. | Meaning |
|---------|---------------------------------------|
| 0 | CHANnel1, clipping on the upper limit |
| 1 | CHANnel1, clipping on the lower limit |
| 2 | CHANnel2, clipping on the upper limit |
| 3 | CHANnel2, clipping on the lower limit |
| 4 | CHANnel3, clipping on the upper limit |
| 5 | CHANnel3, clipping on the lower limit |
| 6 | CHANnel4, clipping on the upper limit |
| 7 | CHANnel4, clipping on the lower limit |

B.3.4.4 STATus:QUESTIONable:LIMit register

This register contains information about the observance of the limits of measurements. This bit is set if the limits of the assigned measurement are violated.

Table B-8: Bits in the STATus:QUESTIONable:LIMit register

| Bit No. | Meaning |
|---------|---------|
| 0 | MEAS1 |
| 1 | MEAS2 |
| 2 | MEAS3 |
| 3 | MEAS4 |

B.3.4.5 STATus:QUESTIONable:MASK register

This register contains information about the violation of masks. This bit is set if the assigned mask is violated.

Table B-9: Bits in the STATus:QUESTIONable:MASK register

| Bit No. | Meaning |
|---------|---------|
| 0 | MASK1 |

B.4 Application of the Status Reporting System

The purpose of the status reporting system is to monitor the status of one or several devices in a measuring system. To do this and react appropriately, the controller must receive and evaluate the information of all devices. The following standard methods are used:

- **Service request** (SRQ) initiated by the instrument
- **Serial poll** of all devices in the bus system, initiated by the controller in order to find out who sent a SRQ and why
- **Parallel poll** of all devices
- Query of a **specific instrument status** by means of commands
- Query of the **error queue**

B.4.1 Service Request

Under certain circumstances, the instrument can send a service request (SRQ) to the controller. Usually this service request initiates an interrupt at the controller, to which the control program can react appropriately. As evident from [Figure B-2](#), an SRQ is always initiated if one or several of bits 2, 3, 4, 5 or 7 of the status byte are set and enabled in the SRE. Each of these bits combines the information of a further register, the error queue or the output buffer. The `ENABLe` parts of the status registers can be set such that arbitrary bits in an arbitrary status register initiate an SRQ. In order to make use of the possibilities of the service request effectively, all bits should be set to "1" in enable registers SRE and ESE.

The SRQ is the only possibility for the instrument to become active on its own. Each controller program should cause the instrument to initiate a service request if errors occur. The program should react appropriately to the service request.

B.4.2 Serial Poll

In a serial poll, just as with command `*STB`, the status byte of an instrument is queried. However, the query is realized via interface messages and is thus clearly faster.

The serial poll method is defined in IEEE 488.1 and used to be the only standard possibility for different instruments to poll the status byte. The method also works for instruments which do not adhere to SCPI or IEEE 488.2.

The serial poll is mainly used to obtain a fast overview of the state of several instruments connected to the controller.

B.4.3 Query of an instrument status

Each part of any status register can be read using queries. There are two types of commands:

- The common commands `*ESR?`, `*IDN?`, `*IST?`, `*STB?` query the higher-level registers.
- The commands of the `STATus` system query the SCPI registers (`STATus:QUEStionable...`)

The returned value is always a decimal number that represents the bit pattern of the queried register. This number is evaluated by the controller program.

Queries are usually used after an SRQ in order to obtain more detailed information on the cause of the SRQ.

B.4.3.1 Decimal representation of a bit pattern

The STB and ESR registers contain 8 bits, the SCPI registers 16 bits. The contents of a status register are specified and transferred as a single decimal number. To make this possible, each bit is assigned a weighted value. The decimal number is calculated as the sum of the weighted values of all bits in the register that are set to 1.

| | | | | | | | | | |
|--------|---|---|---|---|----|----|----|-----|-----|
| Bits | 0 | 1 | 2 | 3 | 4 | 5 | 6 | 7 | ... |
| Weight | 1 | 2 | 4 | 8 | 16 | 32 | 64 | 128 | ... |

Example:

The decimal value $40 = 32 + 8$ indicates that bits no. 3 and 5 in the status register (e.g. the `QUEStionable` status summary bit and the `ESB` bit in the `STatus Byte`) are set.

B.4.4 Error Queue

Each error state in the instrument leads to an entry in the error queue. The entries of the error queue are detailed plain text error messages that can be looked up in the Error Log or queried via remote control using `SYSTem:ERRor[:NEXT]?`. Each call of `SYSTem:ERRor[:NEXT]?` provides one entry from the error queue. If no error messages are stored there any more, the instrument responds with 0, "No error".

The error queue should be queried after every SRQ in the controller program as the entries describe the cause of an error more precisely than the status registers. Especially in the test phase of a controller program the error queue should be queried regularly since faulty commands from the controller to the instrument are recorded there as well.

B.5 Reset Values of the Status Reporting System

The following table contains the different commands and events causing the status reporting system to be reset. None of the commands, except `*RST` and

SYSTEM:PRESet, influence the functional instrument settings. In particular, DCL does not change the instrument settings.

Table B-10: Reset of the status reporting system

| Event | Switching on supply voltage
Power-On-Status-Clear | | DCL,
SDC
(Device
Clear,
Selected
Device
Clear) | *RST or
SYS-
Tem:PRE
Set | STA-
Tus:PRE-
Set | *CLS |
|--------------------------------------------------------------------------------------------------------------------------|------------------------------------------------------|-----|------------------------------------------------------------------|-----------------------------------|-------------------------|------|
| | 0 | 1 | | | | |
| Clear STB, ESR | - | yes | - | - | - | yes |
| Clear SRE, ESE | - | yes | - | - | - | - |
| Clear EVENT parts of the registers | - | yes | - | - | - | yes |
| Clear ENABLE parts of all OPERATION and QUESTIONABLE registers;
Fill ENABLE parts of all other registers with "1". | - | yes | - | - | yes | - |
| Fill PTRansition parts with "1";
Clear NTRansition parts | - | yes | - | - | yes | - |
| Clear error queue | yes | yes | - | - | - | yes |
| Clear output buffer | yes | yes | yes | 1) | 1) | 1) |
| Clear command processing and input buffer | yes | yes | yes | - | - | - |
| 1) The first command in a command line that immediately follows a <PROGRAM MESSAGE TERMINATOR> clears the output buffer. | | | | | | |

List of Commands

| | |
|--------------------------------------------|-----|
| *CAL? | 286 |
| *CLS | 287 |
| *ESE | 287 |
| *ESR? | 287 |
| *IDN? | 287 |
| *OPC | 287 |
| *OPT? | 288 |
| *PSC | 288 |
| *RST | 288 |
| *SRE | 288 |
| *STB? | 289 |
| *TRG | 289 |
| *WAI | 289 |
| ACQUIRE:AVAILABLE? | 340 |
| ACQUIRE:AVERAge:COMPLete? | 304 |
| ACQUIRE:AVERAge:COUnT | 304 |
| ACQUIRE:AVERAge:CURREnt? | 340 |
| ACQUIRE:AVERAge:RESEt | 304 |
| ACQUIRE:HRESolution | 303 |
| ACQUIRE:INTerpolate | 305 |
| ACQUIRE:MEMory[:MODE] | 338 |
| ACQUIRE:NSINgLe:COUnT | 290 |
| ACQUIRE:NSINgLe:COUnT | 304 |
| ACQUIRE:NSINgLe:COUnT | 340 |
| ACQUIRE:PEAKdetect | 303 |
| ACQUIRE:POINts:ARATE? | 305 |
| ACQUIRE:POINts:AUTomatic | 301 |
| ACQUIRE:POINts:AUTomatic | 339 |
| ACQUIRE:POINts[:VALue] | 301 |
| ACQUIRE:POINts[:VALue] | 339 |
| ACQUIRE:SEGMENTed:STATe | 340 |
| ACQUIRE:SRATE? | 305 |
| ACQUIRE:STATe | 291 |
| ACQUIRE:TYPE | 302 |
| AUToscale | 290 |
| BPLot:AMPLitude:ENABle | 397 |
| BPLot:AMPLitude:MODE | 393 |
| BPLot:AMPLitude:POSition | 397 |
| BPLot:AMPLitude:PROFile:COUnT | 393 |
| BPLot:AMPLitude:PROFile:POINt<n>:AMPLitude | 393 |
| BPLot:AMPLitude:PROFile:POINt<n>:FREQuency | 393 |
| BPLot:AMPLitude:SCALE | 397 |
| BPLot:ENABle | 393 |
| BPLot:EXPort:NAME | 348 |
| BPLot:EXPort:SAVE | 348 |
| BPLot:FREQuency:DATA? | 394 |
| BPLot:FREQuency:STARt | 394 |

| | |
|-----------------------------------------|-----|
| BPLot:FREQuency:STOP..... | 394 |
| BPLot:GAIN:DATA?..... | 396 |
| BPLot:GAIN:ENABle..... | 396 |
| BPLot:GAIN:POSition..... | 396 |
| BPLot:GAIN:SCALe..... | 396 |
| BPLot:INPut[:SOURce]..... | 394 |
| BPLot:MARKer<m>:DIFFerence:FREQ?..... | 398 |
| BPLot:MARKer<m>:DIFFerence:GAIN?..... | 398 |
| BPLot:MARKer<m>:DIFFerence:PHASe?..... | 398 |
| BPLot:MARKer<m>:FREQuency..... | 399 |
| BPLot:MARKer<m>:GAIN?..... | 399 |
| BPLot:MARKer<m>:INDex..... | 399 |
| BPLot:MARKer<m>:PHASe?..... | 399 |
| BPLot:MARKer<m>:SSCReen..... | 399 |
| BPLot:MEASurement:DELay..... | 394 |
| BPLot:MEASurement:POINt[:DISPLAY]..... | 394 |
| BPLot:OUTPut[:SOURce]..... | 395 |
| BPLot:PHASe:DATA?..... | 396 |
| BPLot:PHASe:ENABle?..... | 396 |
| BPLot:PHASe:POSition?..... | 397 |
| BPLot:PHASe:SCALe?..... | 397 |
| BPLot:POINts:LOGarithmic..... | 395 |
| BPLot:REPeat..... | 395 |
| BPLot:RESet..... | 395 |
| BPLot:STATe..... | 395 |
| BUS:CAN:BITRate..... | 470 |
| BUS:CAN:DATA:SOURce..... | 469 |
| BUS:CAN:FCOunt?..... | 474 |
| BUS:CAN:FRAMe<n>:ACKState?..... | 476 |
| BUS:CAN:FRAMe<n>:ACKValue?..... | 476 |
| BUS:CAN:FRAMe<n>:BCOunt?..... | 479 |
| BUS:CAN:FRAMe<n>:BSEPosition?..... | 479 |
| BUS:CAN:FRAMe<n>:BYTE<o>:STATe?..... | 479 |
| BUS:CAN:FRAMe<n>:BYTE<o>:VALue?..... | 480 |
| BUS:CAN:FRAMe<n>:CSSTate?..... | 477 |
| BUS:CAN:FRAMe<n>:CSValue?..... | 477 |
| BUS:CAN:FRAMe<n>:DATA?..... | 476 |
| BUS:CAN:FRAMe<n>:DLCState?..... | 477 |
| BUS:CAN:FRAMe<n>:DLCValue?..... | 478 |
| BUS:CAN:FRAMe<n>:IDSTate?..... | 478 |
| BUS:CAN:FRAMe<n>:IDType?..... | 478 |
| BUS:CAN:FRAMe<n>:IDValue?..... | 478 |
| BUS:CAN:FRAMe<n>:STARt?..... | 475 |
| BUS:CAN:FRAMe<n>:STATus?..... | 475 |
| BUS:CAN:FRAMe<n>:STOP?..... | 476 |
| BUS:CAN:FRAMe<n>:TYPE?..... | 474 |
| BUS:CAN:SAMPlepoint..... | 470 |
| BUS:CAN:TYPE..... | 469 |
| BUS:CPARallel:CLOCK:SLOPe..... | 505 |
| BUS:CPARallel:CLOCK:SOURce..... | 505 |

| | |
|--------------------------------------------|-----|
| BUS:CPARAllel:CS:ENABle..... | 505 |
| BUS:CPARAllel:CS:POLARity..... | 506 |
| BUS:CPARAllel:CS:SOURce..... | 505 |
| BUS:CPARAllel:DATA<m>:SOURce..... | 504 |
| BUS:CPARAllel:FCOunt?..... | 506 |
| BUS:CPARAllel:FRAMe<n>:DATA?..... | 506 |
| BUS:CPARAllel:FRAMe<n>:STARt?..... | 507 |
| BUS:CPARAllel:FRAMe<n>:STATe?..... | 507 |
| BUS:CPARAllel:FRAMe<n>:STOP?..... | 507 |
| BUS:CPARAllel:WIDTh..... | 504 |
| BUS:DSIGnals..... | 435 |
| BUS:DSIZe..... | 436 |
| BUS:FORMAt..... | 435 |
| BUS:HISTory:CONTRol:ENABle]..... | 342 |
| BUS:HISTory:CURRent..... | 342 |
| BUS:HISTory:EXPort:NAME..... | 348 |
| BUS:HISTory:EXPort:SAVE..... | 348 |
| BUS:HISTory:PALL..... | 342 |
| BUS:HISTory:PLAYer:SPEEd..... | 343 |
| BUS:HISTory:PLAYer:STATe..... | 344 |
| BUS:HISTory:REPLay..... | 343 |
| BUS:HISTory:STARt..... | 343 |
| BUS:HISTory:STOP..... | 343 |
| BUS:HISTory:TSABsolute:ALL?..... | 347 |
| BUS:HISTory:TSABsolute?..... | 346 |
| BUS:HISTory:TSDate:ALL?..... | 347 |
| BUS:HISTory:TSDate?..... | 347 |
| BUS:HISTory:TSRelative:ALL?..... | 346 |
| BUS:HISTory:TSRelative?..... | 345 |
| BUS:HISTory:TTABle]:ENABle]..... | 345 |
| BUS:I2C:CLOCK:SOURce..... | 449 |
| BUS:I2C:DATA:SOURce..... | 449 |
| BUS:I2C:FCOunt?..... | 453 |
| BUS:I2C:FRAMe<n>:AACcEss?..... | 454 |
| BUS:I2C:FRAMe<n>:ACcEss?..... | 454 |
| BUS:I2C:FRAMe<n>:ACOMplete?..... | 455 |
| BUS:I2C:FRAMe<n>:ADBStart?..... | 455 |
| BUS:I2C:FRAMe<n>:ADDRes?..... | 455 |
| BUS:I2C:FRAMe<n>:ADEVice?..... | 456 |
| BUS:I2C:FRAMe<n>:AMODE?..... | 456 |
| BUS:I2C:FRAMe<n>:ASTart?..... | 456 |
| BUS:I2C:FRAMe<n>:BCOunt?..... | 457 |
| BUS:I2C:FRAMe<n>:BYTE<o>:ACcEss?..... | 457 |
| BUS:I2C:FRAMe<n>:BYTE<o>:ACKStart?..... | 457 |
| BUS:I2C:FRAMe<n>:BYTE<o>:COMPLete?..... | 458 |
| BUS:I2C:FRAMe<n>:BYTE<o>:STARt?..... | 458 |
| BUS:I2C:FRAMe<n>:BYTE<o>:VALue?..... | 459 |
| BUS:I2C:FRAMe<n>:DATA?..... | 453 |
| BUS:I2C:FRAMe<n>:STARt?..... | 454 |
| BUS:I2C:FRAMe<n>:STATus?..... | 453 |

| | |
|------------------------------------|-----|
| BUS:I2C:FRAMe<n>:STOP? | 454 |
| BUS:LABel | 435 |
| BUS:LABel:STATe | 435 |
| BUS:LIN:BITRate | 485 |
| BUS:LIN:DATA:SOURce | 484 |
| BUS:LIN:FCOunt? | 489 |
| BUS:LIN:FRAMe<n>:BCOunt? | 492 |
| BUS:LIN:FRAMe<n>:BYTE<o>:STATe? | 493 |
| BUS:LIN:FRAMe<n>:BYTE<o>:VALue? | 493 |
| BUS:LIN:FRAMe<n>:CSSTate? | 490 |
| BUS:LIN:FRAMe<n>:CSValue? | 490 |
| BUS:LIN:FRAMe<n>:DATA? | 489 |
| BUS:LIN:FRAMe<n>:IDPValue? | 491 |
| BUS:LIN:FRAMe<n>:IDSTate? | 491 |
| BUS:LIN:FRAMe<n>:IDValue? | 491 |
| BUS:LIN:FRAMe<n>:START? | 489 |
| BUS:LIN:FRAMe<n>:STATus? | 489 |
| BUS:LIN:FRAMe<n>:STOP? | 490 |
| BUS:LIN:FRAMe<n>:SYSTate? | 492 |
| BUS:LIN:FRAMe<n>:SYValue? | 492 |
| BUS:LIN:FRAMe<n>:VERSion? | 492 |
| BUS:LIN:POLarity | 485 |
| BUS:LIN:STANdard | 485 |
| BUS:PARAllel:DATA<m>:SOURce | 504 |
| BUS:PARAllel:FCOunt? | 506 |
| BUS:PARAllel:FRAMe<n>:DATA? | 506 |
| BUS:PARAllel:FRAMe<n>:START? | 507 |
| BUS:PARAllel:FRAMe<n>:STATe? | 507 |
| BUS:PARAllel:FRAMe<n>:STOP? | 507 |
| BUS:PARAllel:WIDTh | 504 |
| BUS:POSition | 436 |
| BUS:RESult | 436 |
| BUS:SPI:BORDER | 439 |
| BUS:SPI:CLOCK:POLarity | 438 |
| BUS:SPI:CLOCK:SOURce | 438 |
| BUS:SPI:CS:POLarity | 437 |
| BUS:SPI:CS:SOURce | 437 |
| BUS:SPI:DATA:POLarity | 439 |
| BUS:SPI:DATA:SOURce | 438 |
| BUS:SPI:FCOunt? | 445 |
| BUS:SPI:FRAMe<n>:DATA:MISO? | 446 |
| BUS:SPI:FRAMe<n>:DATA:MOSI? | 446 |
| BUS:SPI:FRAMe<n>:START? | 445 |
| BUS:SPI:FRAMe<n>:STATus? | 445 |
| BUS:SPI:FRAMe<n>:STOP? | 446 |
| BUS:SPI:FRAMe<n>:WCOunt? | 447 |
| BUS:SPI:FRAMe<n>:WORD<o>:MISO? | 448 |
| BUS:SPI:FRAMe<n>:WORD<o>:MOSI? | 448 |
| BUS:SPI:FRAMe<n>:WORD<o>:START? | 447 |
| BUS:SPI:FRAMe<n>:WORD<o>:STOP? | 447 |

| | |
|---------------------------------------------|-----|
| BUS:SPI:MISO:POLarity..... | 439 |
| BUS:SPI:MISO:SOURce..... | 438 |
| BUS:SPI:MOSI:POLarity..... | 439 |
| BUS:SPI:MOSI:SOURce..... | 438 |
| BUS:SPI:SSIZe..... | 440 |
| BUS:SSPI:BITime..... | 442 |
| BUS:SSPI:BORDer..... | 442 |
| BUS:SSPI:CLOCK:POLarity..... | 441 |
| BUS:SSPI:CLOCK:SOURce..... | 440 |
| BUS:SSPI:DATA:POLarity..... | 441 |
| BUS:SSPI:DATA:SOURce..... | 441 |
| BUS:SSPI:MISO:POLarity..... | 442 |
| BUS:SSPI:MISO:SOURce..... | 441 |
| BUS:SSPI:MOSI:POLarity..... | 442 |
| BUS:SSPI:MOSI:SOURce..... | 441 |
| BUS:SSPI:SSIZe..... | 443 |
| BUS:STATe..... | 434 |
| BUS:TYPE..... | 434 |
| BUS:UART:BAUDrate..... | 461 |
| BUS:UART:BITime..... | 462 |
| BUS:UART:DATA:POLarity..... | 460 |
| BUS:UART:DATA:SOURce..... | 460 |
| BUS:UART:FCOut?..... | 464 |
| BUS:UART:FRAMe<n>:START?..... | 465 |
| BUS:UART:FRAMe<n>:STATe?..... | 465 |
| BUS:UART:FRAMe<n>:STOP?..... | 465 |
| BUS:UART:FRAMe<n>:WCOut?..... | 466 |
| BUS:UART:FRAMe<n>:WORD<o>:RXValue?..... | 468 |
| BUS:UART:FRAMe<n>:WORD<o>:SOURce?..... | 466 |
| BUS:UART:FRAMe<n>:WORD<o>:START?..... | 467 |
| BUS:UART:FRAMe<n>:WORD<o>:STATe?..... | 466 |
| BUS:UART:FRAMe<n>:WORD<o>:STOP?..... | 468 |
| BUS:UART:FRAMe<n>:WORD<o>:TXValue?..... | 468 |
| BUS:UART:FRAMe<n>:WORD<o>:VALue?..... | 468 |
| BUS:UART:PARity..... | 461 |
| BUS:UART:POLarity..... | 460 |
| BUS:UART:RX:FCOut?..... | 464 |
| BUS:UART:RX:FRAMe<n>:START?..... | 465 |
| BUS:UART:RX:FRAMe<n>:STATe?..... | 465 |
| BUS:UART:RX:FRAMe<n>:STOP?..... | 465 |
| BUS:UART:RX:FRAMe<n>:WCOut?..... | 466 |
| BUS:UART:RX:FRAMe<n>:WORD<o>:START?..... | 467 |
| BUS:UART:RX:FRAMe<n>:WORD<o>:STATe?..... | 466 |
| BUS:UART:RX:FRAMe<n>:WORD<o>:STOP?..... | 468 |
| BUS:UART:RX:FRAMe<n>:WORD<o>:VALue?..... | 468 |
| BUS:UART:RX:SOURce..... | 460 |
| BUS:UART:SBIT..... | 461 |
| BUS:UART:SSIZe..... | 461 |
| BUS:UART:TX:FCOut?..... | 464 |
| BUS:UART:TX:FRAMe<n>:START?..... | 465 |

| | |
|-------------------------------------------|-----|
| BUS:UART:TX:FRAMe<n>:STATe? | 465 |
| BUS:UART:TX:FRAMe<n>:STOP? | 465 |
| BUS:UART:TX:FRAMe<n>:WCOut? | 466 |
| BUS:UART:TX:FRAMe<n>:WORD<o>:START? | 467 |
| BUS:UART:TX:FRAMe<n>:WORD<o>:STATe? | 466 |
| BUS:UART:TX:FRAMe<n>:WORD<o>:STOP? | 468 |
| BUS:UART:TX:FRAMe<n>:WORD<o>:VALue? | 468 |
| BUS:UART:TX:SOURce | 460 |
| CALCulate:MATH<m>:DATA:HEADer? | 406 |
| CALCulate:MATH<m>:DATA:POINts? | 406 |
| CALCulate:MATH<m>:DATA:XINCrement? | 410 |
| CALCulate:MATH<m>:DATA:XORigin? | 409 |
| CALCulate:MATH<m>:DATA:YINCrement? | 411 |
| CALCulate:MATH<m>:DATA:YORigin? | 410 |
| CALCulate:MATH<m>:DATA:YRESolution? | 411 |
| CALCulate:MATH<m>:DATA? | 406 |
| CALCulate:MATH<m>:HISTory:CONTRol:ENABle] | 342 |
| CALCulate:MATH<m>:HISTory:CURRent | 342 |
| CALCulate:MATH<m>:HISTory:PALL | 342 |
| CALCulate:MATH<m>:HISTory:PLAYer:SPEed | 343 |
| CALCulate:MATH<m>:HISTory:PLAYer:STATe | 344 |
| CALCulate:MATH<m>:HISTory:REPLay | 343 |
| CALCulate:MATH<m>:HISTory:STARt | 343 |
| CALCulate:MATH<m>:HISTory:STOP | 343 |
| CALCulate:MATH<m>:HISTory:TSABsolute:ALL? | 347 |
| CALCulate:MATH<m>:HISTory:TSABsolute? | 346 |
| CALCulate:MATH<m>:HISTory:TSDate:ALL? | 347 |
| CALCulate:MATH<m>:HISTory:TSDate? | 347 |
| CALCulate:MATH<m>:HISTory:TSRelative:ALL? | 346 |
| CALCulate:MATH<m>:HISTory:TSRelative? | 345 |
| CALCulate:MATH<m>:HISTory:TTABLE[:ENABle] | 345 |
| CALCulate:MATH<m>:LABel | 319 |
| CALCulate:MATH<m>:LABel:STATe | 320 |
| CALCulate:MATH<m>:POSItion | 320 |
| CALCulate:MATH<m>:SCALE | 320 |
| CALCulate:MATH<m>:STATe | 318 |
| CALCulate:MATH<m>[:EXPRession][:DEFine] | 319 |
| CALibration | 426 |
| CALibration:STATe? | 426 |
| CHANnel<m>:AOFF | 292 |
| CHANnel<m>:AON | 292 |
| CHANnel<m>:ARITHmatics | 303 |
| CHANnel<m>:BANDwidth | 294 |
| CHANnel<m>:COUPling | 293 |
| CHANnel<m>:DATA:ENVelope:HEADer? | 405 |
| CHANnel<m>:DATA:ENVelope:XINCrement? | 410 |
| CHANnel<m>:DATA:ENVelope:XORigin? | 409 |
| CHANnel<m>:DATA:ENVelope:YINCrement? | 411 |
| CHANnel<m>:DATA:ENVelope:YORigin? | 410 |
| CHANnel<m>:DATA:ENVelope:YRESolution? | 411 |

| | |
|-------------------------------------|-----|
| CHANnel<m>:DATA:ENVELOpe? | 404 |
| CHANnel<m>:DATA:HEADer? | 403 |
| CHANnel<m>:DATA:POINts | 403 |
| CHANnel<m>:DATA:XINCrement? | 410 |
| CHANnel<m>:DATA:XORigin? | 409 |
| CHANnel<m>:DATA:YINCrement? | 411 |
| CHANnel<m>:DATA:YORigin? | 410 |
| CHANnel<m>:DATA:YRESolution? | 411 |
| CHANnel<m>:DATA? | 402 |
| CHANnel<m>:HISTory:CONTRol:[ENABLE] | 342 |
| CHANnel<m>:HISTory:CURRent | 342 |
| CHANnel<m>:HISTory:EXPort:NAME | 348 |
| CHANnel<m>:HISTory:EXPort:SAVE | 349 |
| CHANnel<m>:HISTory:PALL | 342 |
| CHANnel<m>:HISTory:PLAYer:SPEEd | 343 |
| CHANnel<m>:HISTory:PLAYer:STATe | 344 |
| CHANnel<m>:HISTory:REPLay | 344 |
| CHANnel<m>:HISTory:STARt | 343 |
| CHANnel<m>:HISTory:STOP | 343 |
| CHANnel<m>:HISTory:TSABsolute:ALL? | 347 |
| CHANnel<m>:HISTory:TSABsolute? | 346 |
| CHANnel<m>:HISTory:TSDate:ALL? | 347 |
| CHANnel<m>:HISTory:TSDate? | 347 |
| CHANnel<m>:HISTory:TSRelative:ALL? | 346 |
| CHANnel<m>:HISTory:TSRelative? | 346 |
| CHANnel<m>:HISTory:TTABLE:[ENABLE] | 345 |
| CHANnel<m>:LABel | 297 |
| CHANnel<m>:LABel:STATe | 297 |
| CHANnel<m>:OFFSet | 293 |
| CHANnel<m>:OVERload | 296 |
| CHANnel<m>:POLarity | 294 |
| CHANnel<m>:POSition | 293 |
| CHANnel<m>:RANGe | 292 |
| CHANnel<m>:SCALe | 292 |
| CHANnel<m>:SKEW | 295 |
| CHANnel<m>:STATe | 292 |
| CHANnel<m>:THReshold | 296 |
| CHANnel<m>:THReshold:FINDlevel | 297 |
| CHANnel<m>:THReshold:HYSteresis | 297 |
| CHANnel<m>:TYPE | 302 |
| CHANnel<m>:WCOLor | 295 |
| CHANnel<m>:ZOFFset[VALue] | 295 |
| CURSor<m>:AOFF | 362 |
| CURSor<m>:FUNCTion | 362 |
| CURSor<m>:SNPeak<n> | 365 |
| CURSor<m>:SOURce | 363 |
| CURSor<m>:SPPeak<n> | 365 |
| CURSor<m>:SSCReen | 365 |
| CURSor<m>:STATe | 362 |
| CURSor<m>:SWAVE | 365 |

| | |
|-----------------------------------------|-----|
| CURSor<m>:TRACking:SCALe[:STATe]..... | 365 |
| CURSor<m>:TRACking[:STATe]..... | 364 |
| CURSor<m>:X1Position..... | 364 |
| CURSor<m>:X2Position..... | 364 |
| CURSor<m>:XCoupling..... | 364 |
| CURSor<m>:XDELta:INVerse?..... | 366 |
| CURSor<m>:XDELta[:VALue]?..... | 366 |
| CURSor<m>:Y1Position..... | 364 |
| CURSor<m>:Y2Position..... | 364 |
| CURSor<m>:YCOupling..... | 364 |
| CURSor<m>:YDELta:SLOPe?..... | 367 |
| CURSor<m>:YDELta[:VALue]?..... | 366 |
| DEVice:MODE..... | 367 |
| DIAGnostic:UPDate:INSTall..... | 434 |
| DIAGnostic:UPDate:TRANsfer:CLOSe..... | 433 |
| DIAGnostic:UPDate:TRANsfer:DATA..... | 433 |
| DIAGnostic:UPDate:TRANsfer:OPEN..... | 433 |
| DIgital<m>:CURRent:STATe:MAXimum?..... | 497 |
| DIgital<m>:CURRent:STATe:MINimum?..... | 497 |
| DIgital<m>:DATA:HEADer?..... | 502 |
| DIgital<m>:DATA:POINts..... | 503 |
| DIgital<m>:DATA:XINCrement?..... | 410 |
| DIgital<m>:DATA:XORigin?..... | 409 |
| DIgital<m>:DATA:YINCrement?..... | 411 |
| DIgital<m>:DATA:YORigin?..... | 410 |
| DIgital<m>:DATA:YRESolution?..... | 411 |
| DIgital<m>:DATA?..... | 502 |
| DIgital<m>:DISPlay..... | 498 |
| DIgital<m>:HISTory:CONTrol:ENABle]..... | 342 |
| DIgital<m>:HISTory:CURRent..... | 342 |
| DIgital<m>:HISTory:EXPort:NAME..... | 348 |
| DIgital<m>:HISTory:EXPort:SAVE..... | 348 |
| DIgital<m>:HISTory:PALL..... | 342 |
| DIgital<m>:HISTory:PLAYer:SPEEd..... | 343 |
| DIgital<m>:HISTory:PLAYer:STATe..... | 344 |
| DIgital<m>:HISTory:REPLay..... | 343 |
| DIgital<m>:HISTory:START..... | 343 |
| DIgital<m>:HISTory:STOP..... | 343 |
| DIgital<m>:HISTory:TSABsolute:ALL?..... | 347 |
| DIgital<m>:HISTory:TSABsolute?..... | 346 |
| DIgital<m>:HISTory:TSDate:ALL?..... | 347 |
| DIgital<m>:HISTory:TSDate?..... | 347 |
| DIgital<m>:HISTory:TSRelative:ALL?..... | 346 |
| DIgital<m>:HISTory:TSRelative?..... | 345 |
| DIgital<m>:HISTory:TTABLE[:ENABle]..... | 345 |
| DIgital<m>:HYSTEResis..... | 500 |
| DIgital<m>:LABel..... | 501 |
| DIgital<m>:LABel:STATe..... | 501 |
| DIgital<m>:POSItion..... | 500 |
| DIgital<m>:SIZE..... | 500 |

| | |
|---------------------------------------------|-----|
| DIGital<m>:TECHnology..... | 499 |
| DIGital<m>:THReshold..... | 499 |
| DISPlay:CBAR:FFT[:POSition]..... | 375 |
| DISPlay:CBAR:SPECTrogram[:POSition]..... | 381 |
| DISPlay:CBAR:ZOOM[:POSition]..... | 318 |
| DISPlay:CLear[:SCReen]..... | 422 |
| DISPlay:DIALog:CLoSe..... | 423 |
| DISPlay:DIALog:MESSage..... | 423 |
| DISPlay:GRID:ANNotation:TRACk..... | 425 |
| DISPlay:GRID:ANNotation[:ENABle]..... | 425 |
| DISPlay:GRID:STYLe..... | 424 |
| DISPlay:INTensity:BACKlight..... | 424 |
| DISPlay:INTensity:GRID..... | 424 |
| DISPlay:INTensity:WAVEform..... | 424 |
| DISPlay:LANGuage..... | 421 |
| DISPlay:MODE..... | 388 |
| DISPlay:PALette..... | 425 |
| DISPlay:PERsistence:CLear..... | 422 |
| DISPlay:PERsistence:INFinite..... | 423 |
| DISPlay:PERsistence:TIME..... | 422 |
| DISPlay:PERsistence:TYPE..... | 422 |
| DISPlay:PERsistence[:STATe]..... | 423 |
| DISPlay:STYLe..... | 425 |
| DISPlay:XY:XSource..... | 389 |
| DISPlay:XY:Y1Source..... | 389 |
| DISPlay:XY:Y2Source..... | 389 |
| DVM<m>:ENABle..... | 389 |
| DVM<m>:RESult[:ACTual]:STATus?..... | 391 |
| DVM<m>:RESult[:ACTual]?..... | 390 |
| DVM<m>:SOURce..... | 390 |
| DVM<m>:TYPE..... | 390 |
| EXPort:ATABle:NAME..... | 348 |
| EXPort:ATABle:SAVE..... | 349 |
| EXPort:MEASurement:STATistics:ALL:NAME..... | 358 |
| EXPort:MEASurement:STATistics:ALL:SAVE..... | 358 |
| EXPort:MEASurement<m>:STATistics:NAME..... | 357 |
| EXPort:MEASurement<m>:STATistics:SAVE..... | 357 |
| EXPort:SEARch:NAME..... | 338 |
| EXPort:SEARch:SAVE..... | 338 |
| EXPort:WAVEform:NAME..... | 412 |
| EXPort:WAVEform:SAVE..... | 412 |
| EXPort:WAVEform:SOURce..... | 412 |
| FORMat:BORDER..... | 402 |
| FORMat[:DATA]..... | 400 |
| HCOPY:COLor:SCHeme..... | 414 |
| HCOPY:DATA?..... | 413 |
| HCOPY:FORMat..... | 414 |
| HCOPY:LANGuage..... | 414 |
| HCOPY:SIZE:X?..... | 414 |
| HCOPY:SIZE:Y?..... | 414 |

| | |
|---------------------------------------|-----|
| HCOPY[:IMMEDIATE]..... | 413 |
| LOGIC<p>:CURRENT:STATE:MAXIMUM?..... | 497 |
| LOGIC<p>:CURRENT:STATE:MINIMUM?..... | 497 |
| LOGIC<p>:DATA:HEADER?..... | 502 |
| LOGIC<p>:DATA:POINTS..... | 503 |
| LOGIC<p>:DATA:XINCREMENT?..... | 410 |
| LOGIC<p>:DATA:XORIGIN?..... | 409 |
| LOGIC<p>:DATA:YINCREMENT?..... | 411 |
| LOGIC<p>:DATA:YORIGIN?..... | 410 |
| LOGIC<p>:DATA:YRESOLUTION?..... | 411 |
| LOGIC<p>:DATA?..... | 502 |
| LOGIC<p>:HISTORY:CONTROL:ENABLE]..... | 342 |
| LOGIC<p>:HISTORY:CURRENT..... | 342 |
| LOGIC<p>:HISTORY:PALL..... | 342 |
| LOGIC<p>:HISTORY:PLAYER:SPEED..... | 343 |
| LOGIC<p>:HISTORY:PLAYER:STATE..... | 344 |
| LOGIC<p>:HISTORY:REPLAY..... | 344 |
| LOGIC<p>:HISTORY:START..... | 343 |
| LOGIC<p>:HISTORY:STOP..... | 343 |
| LOGIC<p>:HISTORY:TSABSOLUTE:ALL?..... | 347 |
| LOGIC<p>:HISTORY:TSABSOLUTE?..... | 346 |
| LOGIC<p>:HISTORY:TSDATE:ALL?..... | 347 |
| LOGIC<p>:HISTORY:TSDATE?..... | 347 |
| LOGIC<p>:HISTORY:TSRELATIVE:ALL?..... | 346 |
| LOGIC<p>:HISTORY:TSRELATIVE?..... | 345 |
| LOGIC<p>:HISTORY:TTABLE[:ENABLE]..... | 345 |
| LOGIC<p>:HYSTERESIS..... | 500 |
| LOGIC<p>:PROBE[:ENABLE]?..... | 497 |
| LOGIC<p>:STATE..... | 498 |
| LOGIC<p>:THRESHOLD..... | 499 |
| LOGIC<p>:THRESHOLD:UDLEVEL..... | 499 |
| MASK:ACTION:PULSE:EVENT:MODE..... | 370 |
| MASK:ACTION:SCRSave:DESTINATION..... | 370 |
| MASK:ACTION:SCRSave:EVENT:MODE..... | 370 |
| MASK:ACTION:SOUND:EVENT:MODE..... | 369 |
| MASK:ACTION:STOP:EVENT:COUNT..... | 370 |
| MASK:ACTION:STOP:EVENT:MODE..... | 369 |
| MASK:ACTION:WFMSave:DESTINATION..... | 371 |
| MASK:ACTION:WFMSave:EVENT:MODE..... | 370 |
| MASK:ACTION:YOUT:ENABLE..... | 371 |
| MASK:CAPTURE[:MODE]..... | 372 |
| MASK:CHCOPY..... | 368 |
| MASK:COUNT?..... | 372 |
| MASK:DATA:HEADER?..... | 408 |
| MASK:DATA:XINCREMENT?..... | 410 |
| MASK:DATA:XORIGIN?..... | 409 |
| MASK:DATA:YINCREMENT?..... | 411 |
| MASK:DATA:YORIGIN?..... | 410 |
| MASK:DATA:YRESOLUTION?..... | 411 |
| MASK:DATA?..... | 408 |

| | |
|-------------------------------------------|-----|
| MASK:LOAD..... | 369 |
| MASK:RESet:COUnTer..... | 372 |
| MASK:SAVE..... | 369 |
| MASK:SOURce..... | 368 |
| MASK:STATe..... | 368 |
| MASK:TEST..... | 372 |
| MASK:VCOunt?..... | 372 |
| MASK:XWIDth..... | 368 |
| MASK:YPOStion..... | 368 |
| MASK:YSCale..... | 368 |
| MASK:YWIDth..... | 369 |
| MEASurement<m>:ALL[:STATe]..... | 350 |
| MEASurement<m>:AOFF..... | 350 |
| MEASurement<m>:AON..... | 349 |
| MEASurement<m>:AREsult?..... | 350 |
| MEASurement<m>:DELay:SLOPe..... | 353 |
| MEASurement<m>:GATE..... | 359 |
| MEASurement<m>:GATE:ABSolute:STARt..... | 359 |
| MEASurement<m>:GATE:ABSolute:STOP..... | 359 |
| MEASurement<m>:GATE:MODE..... | 359 |
| MEASurement<m>:GATE:RELative:STARt..... | 360 |
| MEASurement<m>:GATE:RELative:STOP..... | 360 |
| MEASurement<m>:MAIN..... | 351 |
| MEASurement<m>:RESult:AVG?..... | 355 |
| MEASurement<m>:RESult:NPEak?..... | 355 |
| MEASurement<m>:RESult:PPEak?..... | 356 |
| MEASurement<m>:RESult:STDDev?..... | 355 |
| MEASurement<m>:RESult:WFMCounT?..... | 356 |
| MEASurement<m>:RESult[:ACTual]?..... | 354 |
| MEASurement<m>:SOURce..... | 353 |
| MEASurement<m>:STATistics:RESet..... | 354 |
| MEASurement<m>:STATistics:VALue:ALL?..... | 356 |
| MEASurement<m>:STATistics:VALue<n>?..... | 357 |
| MEASurement<m>:STATistics:WEIGHt?..... | 356 |
| MEASurement<m>:STATistics[:ENABle]..... | 353 |
| MEASurement<m>[:ENABle]..... | 350 |
| MMEMory:CATalog:LENGth?..... | 418 |
| MMEMory:CATalog?..... | 418 |
| MMEMory:CDIRectory..... | 416 |
| MMEMory:COPI..... | 419 |
| MMEMory:DATA..... | 420 |
| MMEMory:DCATalog:LENGth?..... | 417 |
| MMEMory:DCATalog?..... | 417 |
| MMEMory:DELeTe..... | 419 |
| MMEMory:DRIVes?..... | 415 |
| MMEMory:LOAD:STATe..... | 420 |
| MMEMory:MDIRectory..... | 416 |
| MMEMory:MOVE..... | 419 |
| MMEMory:MSIS..... | 415 |
| MMEMory:NAME..... | 413 |

| | |
|-----------------------------------------------------|-----|
| MMEMory:RDIREctory..... | 416 |
| MMEMory:STORe:STATe..... | 420 |
| PGENerator:FUNCTion..... | 516 |
| PGENerator:MANual:STATe<s>..... | 521 |
| PGENerator:PATtern:ARBitrary:DATA:APPend..... | 519 |
| PGENerator:PATtern:ARBitrary:DATA:APPend:BAND..... | 520 |
| PGENerator:PATtern:ARBitrary:DATA:APPend:BOR..... | 520 |
| PGENerator:PATtern:ARBitrary:DATA:APPend:INDex..... | 520 |
| PGENerator:PATtern:ARBitrary:DATA:LENGth..... | 520 |
| PGENerator:PATtern:ARBitrary:DATA[:SET]..... | 519 |
| PGENerator:PATtern:BURSt:NCYCLE..... | 518 |
| PGENerator:PATtern:BURSt:STATe..... | 518 |
| PGENerator:PATtern:COUNter:DIRection..... | 521 |
| PGENerator:PATtern:COUNter:FREQuency..... | 520 |
| PGENerator:PATtern:FREQuency..... | 518 |
| PGENerator:PATtern:ITIME..... | 518 |
| PGENerator:PATtern:PERiod..... | 517 |
| PGENerator:PATtern:SQUarewave:DCYCLE..... | 521 |
| PGENerator:PATtern:SQUarewave:POLarity..... | 521 |
| PGENerator:PATtern:STATe..... | 517 |
| PGENerator:PATtern:STIME..... | 517 |
| PGENerator:PATtern:TRIGger:EXTern:SLOPe..... | 519 |
| PGENerator:PATtern:TRIGger:MODE..... | 519 |
| PGENerator:PATtern:TRIGger:SINGLE..... | 519 |
| PROBe<m>:SETup:ATTenuation:MANual..... | 298 |
| PROBe<m>:SETup:ATTenuation:UNIT..... | 298 |
| PROBe<m>:SETup:GAIN:MANual..... | 299 |
| PROBe<m>:SETup:GAIN:UNIT..... | 298 |
| REFCurve<m>:DATA:HEADer?..... | 407 |
| REFCurve<m>:DATA:XINCrement?..... | 410 |
| REFCurve<m>:DATA:XORigin?..... | 409 |
| REFCurve<m>:DATA:YINCrement?..... | 411 |
| REFCurve<m>:DATA:YORigin?..... | 410 |
| REFCurve<m>:DATA:YRESolution?..... | 411 |
| REFCurve<m>:DATA?..... | 407 |
| REFCurve<m>:HORizontal:POSition..... | 323 |
| REFCurve<m>:HORizontal:SCALE..... | 323 |
| REFCurve<m>:LABel..... | 324 |
| REFCurve<m>:LOAD..... | 322 |
| REFCurve<m>:LOAD:STATe..... | 323 |
| REFCurve<m>:SAVE..... | 322 |
| REFCurve<m>:SOURce..... | 321 |
| REFCurve<m>:SOURce:CATalog?..... | 321 |
| REFCurve<m>:STATe..... | 322 |
| REFCurve<m>:UPDate..... | 322 |
| REFCurve<m>:VERTical:POSition..... | 323 |
| REFCurve<m>:VERTical:SCALE..... | 324 |
| REFCurve<m>:WCOLor..... | 324 |
| REFLevel:RELative:LOWer..... | 361 |
| REFLevel:RELative:MIDDLE..... | 361 |

| | |
|----------------------------------------------|-----|
| REFLevel:RELative:MODE..... | 360 |
| REFLevel:RELative:UPPer..... | 361 |
| RUN..... | 290 |
| RUNContinuous..... | 290 |
| RUNSingle..... | 290 |
| SEARch:CONDition..... | 325 |
| SEARch:MEASure:LEVel:PEAK:MAGNitude..... | 329 |
| SEARch:MEASure:PEAK:POLarity..... | 329 |
| SEARch:PROTocol:CAN:ACKerror..... | 481 |
| SEARch:PROTocol:CAN:BITSterror..... | 482 |
| SEARch:PROTocol:CAN:CONDition..... | 480 |
| SEARch:PROTocol:CAN:CRCErrror..... | 482 |
| SEARch:PROTocol:CAN:DATA..... | 484 |
| SEARch:PROTocol:CAN:DCONDition..... | 483 |
| SEARch:PROTocol:CAN:DLENgth..... | 483 |
| SEARch:PROTocol:CAN:FORMerror..... | 482 |
| SEARch:PROTocol:CAN:FRAMe..... | 481 |
| SEARch:PROTocol:CAN:FTYPe..... | 482 |
| SEARch:PROTocol:CAN:ICONDition..... | 483 |
| SEARch:PROTocol:CAN:IDENtifier..... | 483 |
| SEARch:PROTocol:CAN:ITYPe..... | 482 |
| SEARch:PROTocol:LIN:CHKSErrror..... | 495 |
| SEARch:PROTocol:LIN:CONDition..... | 494 |
| SEARch:PROTocol:LIN:DATA..... | 496 |
| SEARch:PROTocol:LIN:DCONDition..... | 496 |
| SEARch:PROTocol:LIN:DLENgth..... | 496 |
| SEARch:PROTocol:LIN:FRAMe..... | 494 |
| SEARch:PROTocol:LIN:ICONDition..... | 495 |
| SEARch:PROTocol:LIN:IDENtifier..... | 496 |
| SEARch:PROTocol:LIN:IPERror..... | 495 |
| SEARch:PROTocol:LIN:SYERror..... | 495 |
| SEARch:RCOut?..... | 338 |
| SEARch:RESDiagram:SHOW..... | 336 |
| SEARch:RESult:ALL?..... | 337 |
| SEARch:RESult:BCOut?..... | 336 |
| SEARch:RESult<n>?..... | 337 |
| SEARch:SOURce..... | 326 |
| SEARch:STATe..... | 325 |
| SEARch:TRIGger:DATatoclock:CEdGe..... | 333 |
| SEARch:TRIGger:DATatoclock:CLEVel..... | 333 |
| SEARch:TRIGger:DATatoclock:CLEVel:DELTA..... | 333 |
| SEARch:TRIGger:DATatoclock:CSOURce..... | 332 |
| SEARch:TRIGger:DATatoclock:DLEVel..... | 333 |
| SEARch:TRIGger:DATatoclock:DLEVel:DELTA..... | 333 |
| SEARch:TRIGger:DATatoclock:HTIME..... | 333 |
| SEARch:TRIGger:DATatoclock:STIME..... | 333 |
| SEARch:TRIGger:EDGE:LEVel..... | 326 |
| SEARch:TRIGger:EDGE:LEVel:DELTA..... | 327 |
| SEARch:TRIGger:EDGE:SLOPe..... | 326 |
| SEARch:TRIGger:LEVel:RISetime:LOWer..... | 329 |

| | |
|--------------------------------------------------------|-----|
| SEARCh:TRIGger:LEVel:RISetime:UPPer..... | 329 |
| SEARCh:TRIGger:LEVel:RUNT:LOWer..... | 331 |
| SEARCh:TRIGger:LEVel:RUNT:UPPer..... | 331 |
| SEARCh:TRIGger:PATtern:FUNCTion..... | 334 |
| SEARCh:TRIGger:PATtern:LEVel<n>..... | 335 |
| SEARCh:TRIGger:PATtern:LEVel<n>:DELTA..... | 335 |
| SEARCh:TRIGger:PATtern:SOURce..... | 334 |
| SEARCh:TRIGger:PATtern:WIDTh:DELTA..... | 336 |
| SEARCh:TRIGger:PATtern:WIDTh:RANGe..... | 335 |
| SEARCh:TRIGger:PATtern:WIDTh[:WIDTh]..... | 336 |
| SEARCh:TRIGger:RISetime:DELTA..... | 330 |
| SEARCh:TRIGger:RISetime:RANGe..... | 330 |
| SEARCh:TRIGger:RISetime:SLOPe..... | 329 |
| SEARCh:TRIGger:RISetime:TIME..... | 330 |
| SEARCh:TRIGger:RUNT:DELTA..... | 332 |
| SEARCh:TRIGger:RUNT:POLarity..... | 331 |
| SEARCh:TRIGger:RUNT:RANGe..... | 331 |
| SEARCh:TRIGger:RUNT:WIDTh..... | 332 |
| SEARCh:TRIGger:WIDTh:DELTA..... | 328 |
| SEARCh:TRIGger:WIDTh:LEVel..... | 327 |
| SEARCh:TRIGger:WIDTh:LEVel:DELTA..... | 327 |
| SEARCh:TRIGger:WIDTh:POLarity..... | 327 |
| SEARCh:TRIGger:WIDTh:RANGe..... | 328 |
| SEARCh:TRIGger:WIDTh:WIDTh..... | 328 |
| SINGLE..... | 290 |
| SPECtrum:DIAGram:COLor:MAGNitude:MODE..... | 387 |
| SPECtrum:DIAGram:COLor:MAXimum[:LEVel]..... | 387 |
| SPECtrum:DIAGram:COLor:MINimum[:LEVel]..... | 388 |
| SPECtrum:DIAGram:COLor:SCHEME:FDOMain..... | 388 |
| SPECtrum:DIAGram:COLor:SCHEME:SPECTrogram..... | 388 |
| SPECtrum:DIAGram:SPECTrogram[:ENABLE]..... | 388 |
| SPECtrum:FREQuency:AVERage:COMplete?..... | 377 |
| SPECtrum:FREQuency:AVERage:COUNt..... | 377 |
| SPECtrum:FREQuency:BANDwidth[:RESolution]:AUTO..... | 387 |
| SPECtrum:FREQuency:BANDwidth[:RESolution]:RATio..... | 376 |
| SPECtrum:FREQuency:BANDwidth[:RESolution][:VALue]..... | 376 |
| SPECtrum:FREQuency:CENTer..... | 375 |
| SPECtrum:FREQuency:FULLspan..... | 375 |
| SPECtrum:FREQuency:MAGNitude:SCALE..... | 374 |
| SPECtrum:FREQuency:POSition..... | 374 |
| SPECtrum:FREQuency:RESet..... | 377 |
| SPECtrum:FREQuency:SCALE..... | 375 |
| SPECtrum:FREQuency:SPAN..... | 375 |
| SPECtrum:FREQuency:START..... | 376 |
| SPECtrum:FREQuency:STOP..... | 376 |
| SPECtrum:FREQuency:WINDow:TYPE..... | 373 |
| SPECtrum:HISTory:CURRent..... | 342 |
| SPECtrum:HISTory:EXPort:NAME..... | 348 |
| SPECtrum:HISTory:EXPort:SAVE..... | 348 |
| SPECtrum:HISTory:PALL..... | 342 |

| | |
|--------------------------------------------------|-----|
| SPECTrum:HISTory:PLAYer:SPEed..... | 343 |
| SPECTrum:HISTory:PLAYer:STATe..... | 344 |
| SPECTrum:HISTory:REPLay..... | 344 |
| SPECTrum:HISTory:STARt..... | 343 |
| SPECTrum:HISTory:STOP..... | 343 |
| SPECTrum:HISTory:TSABsolute:ALL?..... | 347 |
| SPECTrum:HISTory:TSABsolute?..... | 346 |
| SPECTrum:HISTory:TSDate:ALL?..... | 347 |
| SPECTrum:HISTory:TSDate?..... | 347 |
| SPECTrum:HISTory:TSRelative:ALL?..... | 346 |
| SPECTrum:HISTory:TSRelative?..... | 346 |
| SPECTrum:MARKer:RCOunt?..... | 385 |
| SPECTrum:MARKer:REFerence:SETup:CMPeak..... | 382 |
| SPECTrum:MARKer:REFerence:SETup:CSCReen..... | 383 |
| SPECTrum:MARKer:REFerence:SETup:FREQuency..... | 383 |
| SPECTrum:MARKer:REFerence:SETup:INDex..... | 383 |
| SPECTrum:MARKer:REFerence:SETup:MODE..... | 383 |
| SPECTrum:MARKer:REFerence:SETup:SPAN..... | 383 |
| SPECTrum:MARKer:RESult<n>:ALL:DELTA?..... | 385 |
| SPECTrum:MARKer:RESult<n>:ALL?..... | 385 |
| SPECTrum:MARKer:RESult<n>:DELTA?..... | 386 |
| SPECTrum:MARKer:RESult<n>:FREQuency:DELTA?..... | 386 |
| SPECTrum:MARKer:RESult<n>:FREQuency?..... | 386 |
| SPECTrum:MARKer:RESult<n>:LEVel:DELTA?..... | 387 |
| SPECTrum:MARKer:RESult<n>:LEVel?..... | 386 |
| SPECTrum:MARKer:RESult<n>?..... | 385 |
| SPECTrum:MARKer:RMARker:FREQuency?..... | 384 |
| SPECTrum:MARKer:RMARker:LEVel?..... | 384 |
| SPECTrum:MARKer:RMARker?..... | 384 |
| SPECTrum:MARKer:RMODE..... | 384 |
| SPECTrum:MARKer:RTABLE:ENABLE..... | 381 |
| SPECTrum:MARKer:SETup:DISTance..... | 382 |
| SPECTrum:MARKer:SETup:EXCURsion..... | 382 |
| SPECTrum:MARKer:SETup:MLEVel..... | 382 |
| SPECTrum:MARKer:SETup:MMODE..... | 382 |
| SPECTrum:MARKer:SETup:MWIDth..... | 382 |
| SPECTrum:MARKer:SOURce..... | 381 |
| SPECTrum:MARKer[:ENABLE]..... | 381 |
| SPECTrum:SOURce..... | 373 |
| SPECTrum:SPECTrogram:RESEt..... | 380 |
| SPECTrum:SPECTrogram:SCALE..... | 380 |
| SPECTrum:TIME:POSItion..... | 376 |
| SPECTrum:TIME:RANGE..... | 377 |
| SPECTrum:WAVEform:AVERAge:DATA:HEADer?..... | 378 |
| SPECTrum:WAVEform:AVERAge:DATA:POINts?..... | 379 |
| SPECTrum:WAVEform:AVERAge:DATA:XINCrement?..... | 379 |
| SPECTrum:WAVEform:AVERAge:DATA:XORigin?..... | 379 |
| SPECTrum:WAVEform:AVERAge:DATA:YINCrement?..... | 379 |
| SPECTrum:WAVEform:AVERAge:DATA:YORigin?..... | 380 |
| SPECTrum:WAVEform:AVERAge:DATA:YRESolution?..... | 380 |

| | |
|---------------------------------------------------|-----|
| SPECTrum:WAVeform:AVERAge:DATA?..... | 378 |
| SPECTrum:WAVeform:AVERAge[:ENABLE]..... | 377 |
| SPECTrum:WAVeform:MAXimum:DATA:HEADer?..... | 378 |
| SPECTrum:WAVeform:MAXimum:DATA:POINts?..... | 379 |
| SPECTrum:WAVeform:MAXimum:DATA:XINCrement?..... | 379 |
| SPECTrum:WAVeform:MAXimum:DATA:XORigin?..... | 379 |
| SPECTrum:WAVeform:MAXimum:DATA:YINCrement?..... | 379 |
| SPECTrum:WAVeform:MAXimum:DATA:YORigin?..... | 380 |
| SPECTrum:WAVeform:MAXimum:DATA:YRESolution?..... | 380 |
| SPECTrum:WAVeform:MAXimum:DATA?..... | 378 |
| SPECTrum:WAVeform:MAXimum[:ENABLE]..... | 377 |
| SPECTrum:WAVeform:MINimum:DATA:HEADer?..... | 379 |
| SPECTrum:WAVeform:MINimum:DATA:POINts?..... | 379 |
| SPECTrum:WAVeform:MINimum:DATA:XINCrement?..... | 379 |
| SPECTrum:WAVeform:MINimum:DATA:XORigin?..... | 379 |
| SPECTrum:WAVeform:MINimum:DATA:YINCrement?..... | 379 |
| SPECTrum:WAVeform:MINimum:DATA:YORigin?..... | 380 |
| SPECTrum:WAVeform:MINimum:DATA:YRESolution?..... | 380 |
| SPECTrum:WAVeform:MINimum:DATA?..... | 378 |
| SPECTrum:WAVeform:MINimum[:ENABLE]..... | 377 |
| SPECTrum:WAVeform:SPECTrum:DATA:HEADer?..... | 379 |
| SPECTrum:WAVeform:SPECTrum:DATA:POINts?..... | 379 |
| SPECTrum:WAVeform:SPECTrum:DATA:XINCrement?..... | 379 |
| SPECTrum:WAVeform:SPECTrum:DATA:XORigin?..... | 379 |
| SPECTrum:WAVeform:SPECTrum:DATA:YINCrement?..... | 379 |
| SPECTrum:WAVeform:SPECTrum:DATA:YORigin?..... | 380 |
| SPECTrum:WAVeform:SPECTrum:DATA:YRESolution?..... | 380 |
| SPECTrum:WAVeform:SPECTrum:DATA?..... | 378 |
| SPECTrum:WAVeform:SPECTrum[:ENABLE]..... | 377 |
| SPECTrum[:STATe]..... | 373 |
| STATus:OPERation:CONDition?..... | 522 |
| STATus:OPERation:ENABLE..... | 523 |
| STATus:OPERation:NTRansition..... | 523 |
| STATus:OPERation:PTRansition..... | 523 |
| STATus:OPERation[:EVENT]?..... | 523 |
| STATus:PRESet..... | 525 |
| STATus:QUEStionable:ADCState:CONDition?..... | 525 |
| STATus:QUEStionable:ADCState:ENABLE..... | 525 |
| STATus:QUEStionable:ADCState:NTRansition..... | 526 |
| STATus:QUEStionable:ADCState:PTRansition..... | 527 |
| STATus:QUEStionable:ADCState[:EVENT]?..... | 526 |
| STATus:QUEStionable:CONDition?..... | 525 |
| STATus:QUEStionable:COVerload:CONDition?..... | 525 |
| STATus:QUEStionable:COVerload:ENABLE..... | 525 |
| STATus:QUEStionable:COVerload:NTRansition..... | 526 |
| STATus:QUEStionable:COVerload:PTRansition..... | 527 |
| STATus:QUEStionable:COVerload[:EVENT]?..... | 526 |
| STATus:QUEStionable:ENABLE..... | 525 |
| STATus:QUEStionable:LIMit:CONDition?..... | 525 |
| STATus:QUEStionable:LIMit:ENABLE..... | 526 |

| | |
|--------------------------------------------------------|-----|
| STATus:QUEStionable:LIMit:NTRansition..... | 526 |
| STATus:QUEStionable:LIMit:PTRansition..... | 527 |
| STATus:QUEStionable:LIMit[:EVENT]?..... | 526 |
| STATus:QUEStionable:MASK:CONDition?..... | 525 |
| STATus:QUEStionable:MASK:ENABLE..... | 526 |
| STATus:QUEStionable:MASK:NTRansition..... | 526 |
| STATus:QUEStionable:MASK:PTRansition..... | 527 |
| STATus:QUEStionable:MASK[:EVENT]?..... | 526 |
| STATus:QUEStionable:NTRansition..... | 526 |
| STATus:QUEStionable:PTRansition..... | 527 |
| STATus:QUEStionable[:EVENT]?..... | 526 |
| STOP..... | 291 |
| SYSTem:BEEPer:CONTRol:STATe..... | 428 |
| SYSTem:BEEPer:ERRor:STATe..... | 428 |
| SYSTem:BEEPer:TRIG:STATe..... | 428 |
| SYSTem:BEEPer[:IMMediate]..... | 428 |
| SYSTem:COMMunicate:INTERface:ETHernet:DHCP..... | 430 |
| SYSTem:COMMunicate:INTERface:ETHernet:GATeway..... | 430 |
| SYSTem:COMMunicate:INTERface:ETHernet:HTTPport..... | 431 |
| SYSTem:COMMunicate:INTERface:ETHernet:IPADdress..... | 430 |
| SYSTem:COMMunicate:INTERface:ETHernet:IPPort..... | 431 |
| SYSTem:COMMunicate:INTERface:ETHernet:MACaddress?..... | 431 |
| SYSTem:COMMunicate:INTERface:ETHernet:SUBNet..... | 430 |
| SYSTem:COMMunicate:INTERface:ETHernet:TRANSfer..... | 431 |
| SYSTem:COMMunicate:INTERface:ETHernet:VXIIPort..... | 431 |
| SYSTem:COMMunicate:INTERface:USB:CLASs..... | 432 |
| SYSTem:COMMunicate:INTERface[:SElect]..... | 427 |
| SYSTem:DATE..... | 427 |
| SYSTem:DFPPrint?..... | 429 |
| SYSTem:EDUCation:PRESet..... | 429 |
| SYSTem:ERRor:ALL?..... | 429 |
| SYSTem:ERRor[:NEXT]?..... | 428 |
| SYSTem:NAME..... | 427 |
| SYSTem:PRESet..... | 429 |
| SYSTem:SET..... | 428 |
| SYSTem:TIME..... | 427 |
| SYSTem:TREE?..... | 429 |
| TCOunter:ENABLE..... | 391 |
| TCOunter:RESult[:ACTual]:FREQuency?..... | 392 |
| TCOunter:RESult[:ACTual]:PERiod?..... | 392 |
| TCOunter:SOURce..... | 392 |
| TIMebase:ACQTime..... | 300 |
| TIMebase:DIVisions?..... | 300 |
| TIMebase:POSition..... | 299 |
| TIMebase:RANGE..... | 300 |
| TIMebase:RATime?..... | 300 |
| TIMebase:REFerence..... | 300 |
| TIMebase:ROLL:AUTomatic..... | 304 |
| TIMebase:ROLL:MTIME..... | 305 |
| TIMebase:SCALE..... | 299 |

| | |
|--------------------------------------|-----|
| TIMebase:ZOOM:POSition..... | 318 |
| TIMebase:ZOOM:SCALe..... | 317 |
| TIMebase:ZOOM:STATe..... | 317 |
| TIMebase:ZOOM:TIME..... | 317 |
| TRIGger:A:CAN:ACKerror..... | 473 |
| TRIGger:A:CAN:BITSterror..... | 473 |
| TRIGger:A:CAN:CRCerror..... | 473 |
| TRIGger:A:CAN:DATA..... | 473 |
| TRIGger:A:CAN:DCONdition..... | 472 |
| TRIGger:A:CAN:DLC..... | 472 |
| TRIGger:A:CAN:FORMerror..... | 474 |
| TRIGger:A:CAN:FTYPE..... | 471 |
| TRIGger:A:CAN:ICONdition..... | 472 |
| TRIGger:A:CAN:IDENtifier..... | 472 |
| TRIGger:A:CAN:ITYPE..... | 471 |
| TRIGger:A:CAN:TYPE..... | 471 |
| TRIGger:A:EDGE:COUPling..... | 309 |
| TRIGger:A:EDGE:FILTer:HFReject..... | 310 |
| TRIGger:A:EDGE:FILTer:NREJect..... | 310 |
| TRIGger:A:EDGE:SLOPe..... | 308 |
| TRIGger:A:FINDlevel..... | 309 |
| TRIGger:A:HOLDoff:MODE..... | 308 |
| TRIGger:A:HOLDoff:TIME..... | 308 |
| TRIGger:A:HYSTeresis..... | 309 |
| TRIGger:A:I2C:ACCess..... | 450 |
| TRIGger:A:I2C:ADDRess..... | 451 |
| TRIGger:A:I2C:AMODE..... | 451 |
| TRIGger:A:I2C:MODE..... | 450 |
| TRIGger:A:I2C:PATtern..... | 451 |
| TRIGger:A:I2C:PLENght..... | 452 |
| TRIGger:A:I2C:POFFset..... | 452 |
| TRIGger:A:LEVel<n>:HYSTeresis..... | 310 |
| TRIGger:A:LEVel<n>[:VALue]..... | 309 |
| TRIGger:A:LIN:CHKSError..... | 486 |
| TRIGger:A:LIN:DATA..... | 487 |
| TRIGger:A:LIN:DCONdition..... | 488 |
| TRIGger:A:LIN:DLENght..... | 488 |
| TRIGger:A:LIN:ICONdition..... | 487 |
| TRIGger:A:LIN:IDENtifier..... | 487 |
| TRIGger:A:LIN:IPERror..... | 487 |
| TRIGger:A:LIN:SYERror..... | 487 |
| TRIGger:A:LIN:TYPE..... | 486 |
| TRIGger:A:MODE..... | 307 |
| TRIGger:A:PATtern:CONDItion..... | 314 |
| TRIGger:A:PATtern:FUNCTion..... | 314 |
| TRIGger:A:PATtern:MODE..... | 315 |
| TRIGger:A:PATtern:SOURce..... | 313 |
| TRIGger:A:PATtern:WIDTh:DELTA..... | 316 |
| TRIGger:A:PATtern:WIDTh:RANGe..... | 315 |
| TRIGger:A:PATtern:WIDTh[:WIDTh]..... | 315 |

| | |
|---------------------------------------------|-----|
| TRIGger:A:SOURce..... | 307 |
| TRIGger:A:SOURce:SPI..... | 443 |
| TRIGger:A:SOURce:UART..... | 462 |
| TRIGger:A:SPI:MODE..... | 443 |
| TRIGger:A:SPI:PATtern..... | 444 |
| TRIGger:A:SPI:PLENght..... | 444 |
| TRIGger:A:SPI:POFFset..... | 444 |
| TRIGger:A:TIMeout:RANGe..... | 316 |
| TRIGger:A:TIMeout:TIME..... | 316 |
| TRIGger:A:TV:FIELD..... | 313 |
| TRIGger:A:TV:LINE..... | 313 |
| TRIGger:A:TV:POLarity..... | 312 |
| TRIGger:A:TV:STANdard..... | 312 |
| TRIGger:A:TYPE..... | 307 |
| TRIGger:A:UART:MODE..... | 462 |
| TRIGger:A:UART:PATtern..... | 463 |
| TRIGger:A:UART:PLENght..... | 463 |
| TRIGger:A:UART:POFFset..... | 463 |
| TRIGger:A:WIDTh:DELTA..... | 312 |
| TRIGger:A:WIDTh:POLarity..... | 311 |
| TRIGger:A:WIDTh:RANGe..... | 311 |
| TRIGger:A:WIDTh:WIDTh..... | 311 |
| TRIGger:OUT:MODE..... | 432 |
| TRIGger:OUT:PLENght..... | 432 |
| TRIGger:OUT:POLarity..... | 433 |
| WGENerator:ARBitrary:RANGe:START..... | 511 |
| WGENerator:ARBitrary:RANGe:STOP..... | 511 |
| WGENerator:ARBitrary:SOURce..... | 510 |
| WGENerator:ARBitrary:UPDate..... | 511 |
| WGENerator:ARBitrary:VISible..... | 511 |
| WGENerator:ARBitrary[:FILE]:NAME..... | 511 |
| WGENerator:ARBitrary[:FILE]:OPEN..... | 511 |
| WGENerator:BURSt:ITIME..... | 512 |
| WGENerator:BURSt:NCYCLE..... | 512 |
| WGENerator:BURSt:PHASe..... | 512 |
| WGENerator:BURSt[:STATe]..... | 512 |
| WGENerator:FREQuency..... | 509 |
| WGENerator:FUNCTion..... | 508 |
| WGENerator:FUNCTion:EXPOntial:POLarity..... | 509 |
| WGENerator:FUNCTion:PULSe:DCYCLE..... | 509 |
| WGENerator:FUNCTion:PULSe:ETIME..... | 509 |
| WGENerator:FUNCTion:RAMP:POLarity..... | 509 |
| WGENerator:MODulation:AM:DEPTH..... | 514 |
| WGENerator:MODulation:AM:FREQuency..... | 513 |
| WGENerator:MODulation:ASK:DEPTH..... | 514 |
| WGENerator:MODulation:ASK:FREQuency..... | 514 |
| WGENerator:MODulation:FM:DEVIation..... | 514 |
| WGENerator:MODulation:FM:FREQuency..... | 514 |
| WGENerator:MODulation:FSK:HFREQuency..... | 514 |
| WGENerator:MODulation:FSK:RATE..... | 515 |

| | |
|------------------------------------------|-----|
| WGENerator:MODulation:FUNCTion..... | 513 |
| WGENerator:MODulation:RAMP:POLarity..... | 515 |
| WGENerator:MODulation:TYPE..... | 513 |
| WGENerator:MODulation[:ENABLE]..... | 513 |
| WGENerator:NOISe:ABSolute..... | 510 |
| WGENerator:NOISe:RELative..... | 510 |
| WGENerator:OUTPut:DESTination..... | 510 |
| WGENerator:OUTPut:LOAD..... | 510 |
| WGENerator:OUTPut[:ENABLE]..... | 510 |
| WGENerator:SWEep:FEND..... | 515 |
| WGENerator:SWEep:FStart..... | 515 |
| WGENerator:SWEep:TIME..... | 515 |
| WGENerator:SWEep:TYPE..... | 515 |
| WGENerator:SWEep[:ENABLE]..... | 516 |
| WGENerator:VOLTage..... | 508 |
| WGENerator:VOLTage:OFFSet..... | 509 |